

Environmental Protection Department

Contract No. HY/2012/06

**Widening of Fanling Highway
– Tai Hang to Wo Hop Shek
Interchange**

**Monthly EM&A Report
For March 2021**

[04/2021]

	Name	Signature
Prepared & Checked:	Alex Chan	
Reviewed & Approved:	Y W Fung	

Version:	Rev. 0	Date: 13 April 2021
----------	--------	---------------------

Disclaimer

This report is prepared for Environmental Protection Department and is given for its sole benefit in relation to and pursuant to Contract No. HY/2012/06 and may not be disclosed to, quoted to or relied upon by any person other than Environmental Protection Department without our prior written consent. No person (other than Environmental Protection Department) into whose possession a copy of this report comes may rely on this report without our express written consent and Environmental Protection Department may not rely on it for any purpose other than as described above.

AECOM Asia Co. Ltd.
12/F, Grand Central Plaza, Tower 2, 138 Shatin Rural Committee Road, Shatin, NT, Hong Kong
Tel: (852) 3922 9000 Fax: (852) 2317 7609 www.aecom.com

Hyder-Arup-Black & Veatch Joint Venture
c/o Arcadis
17/F, Two Harbour Square,
180 Wai Yip Street,
Kwun Tong, Hong Kong
Attn: Mr. James Penny

Your Reference

Our Reference
AFK/EC/ST/cy/T329380/2
2.05/L-0375

3/F International Trade
Tower
348 Kwun Tong Road
Kowloon
Hong Kong

T +852 2828 5757
F +852 2827 1823
mottmac.hk

Environmental Monitoring and Audit (EM&A) for Widening of Tolo Highway/Fanling Highway between Island House Interchange and Fanling Stage 2 (between Tai Hang to Wo Hop Shek Interchange) Environmental Permit No. EP-324/2008/E Condition 3.3 – Submission of Monthly EM&A Report – March 2021 for the portion of Stage 2 works under Contract No. HY/2012/06

12 April 2021
By Fax (2805 5028) & Hand

We refer to the Monthly EM&A Report – March 2021 received on 9 April 2021 submitted by the Environmental Team via email. Pursuant to Environmental Permit Condition 3.3, I hereby verify the Monthly EM&A Report – March 2021 for the portion of works under Stage 2 of the captioned Project which is managed under Contract No. HY/2012/06.

Yours faithfully
for MOTT MACDONALD HONG KONG LIMITED

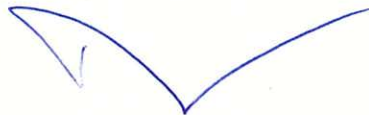

Steven Tang
Independent Environmental Checker

c.c.
HyD
AECOM

Mr. Ricky Yeung
Mr. Y W Fung

By Fax (2714 5198)
By Fax (3922 9797)

	Page
EXECUTIVE SUMMARY	3
1 INTRODUCTION	5
1.1 Background	5
1.2 Scope of Report	6
1.3 Project Organization	6
1.4 Summary of Construction Works	7
1.5 Summary of EM&A Programme Requirements	7
2 AIR QUALITY MONITORING	8
2.1 Monitoring Requirements	8
2.2 Monitoring Equipment	8
2.3 Monitoring Locations	8
2.4 Monitoring Parameters and Frequency	8
2.5 Monitoring Methodology	9
2.6 Monitoring Schedule for the Reporting period	10
2.7 Results and Observations	11
3 NOISE MONITORING	12
3.1 Monitoring Requirements	12
3.2 Monitoring Equipment	12
3.3 Monitoring Locations	12
3.4 Monitoring Parameters and Frequency	12
3.5 Monitoring Methodology	13
3.6 Monitoring Schedule for the Reporting period	13
3.7 Monitoring Results	14
4 ENVIRONMENTAL SITE INSPECTION AND AUDIT	15
4.1 Site Inspection	15
4.2 Advice on the Solid and Liquid Waste Management Status	16
4.3 Environmental Licenses and Permits	17
4.4 Implementation Status of Environmental Mitigation Measures	18
4.5 Summary of Exceedances of the Environmental Quality Performance Limit	18
4.6 Summary of Complaints, Notification of Summons and Successful Prosecutions	18
5 FUTURE KEY ISSUES	19
5.1 Construction Programme for the Coming Months	19
5.2 Key Issues for the Coming Month	19
5.3 Monitoring Schedule for the Coming Month	19
6 CONCLUSIONS AND RECOMMENDATIONS	20
6.1 Conclusions	20
6.2 Recommendations	20

List of Tables

Table 1.1	Contact Information of Key Personnel
Table 2.1	Air Quality Monitoring Equipment
Table 2.2	Locations of Impact Air Quality Monitoring Station
Table 2.3	Air Quality Monitoring Parameters and Frequency
Table 2.4	Summary of 1-hour TSP Monitoring Results in the Reporting Period
Table 2.5	Summary of 24-hour TSP Monitoring Results in the Reporting Period
Table 3.1	Noise Monitoring Equipment
Table 3.2	Locations of Impact Noise Monitoring Stations
Table 3.3	Noise Monitoring Parameters, Frequency and Duration
Table 3.4	Summary of Construction Noise Monitoring Results in the Reporting Period
Table 4.1	Summary of Waste Flow Table for Contract No. HY/2012/06
Table 4.2	Summary of Environmental Licensing and Permit Status

Figures

Figure 1.1	General Project Layout Plan of Contract No. HY/2012/06
Figure 1.2	General Project Layout Plan of Contract No. 02/HY/2015 (Works Order Nos. CB128520-5 and CB128519-0)
Figure 1.3a-b	Locations of Monitoring Station
Figure 4.1	Environmental Complaint Handling Procedures

List of Appendices

Appendix A	Project Organization Structure
Appendix B	Construction Programme
Appendix C	Implementation Schedule of Environmental Mitigation Measures (EMIS)
Appendix D	Summary of Action and Limit Levels
Appendix E	Calibration Certificates of Monitoring Equipments
Appendix F	EM&A Monitoring Schedules
Appendix G	Impact Air Quality Monitoring Results and their Graphical Presentation
Appendix H	Meteorological Data for the Reporting period
Appendix I	Impact Daytime Construction Noise Monitoring Results and their Graphical Presentation
Appendix J	Event Action Plan
Appendix K	Site Inspection Summaries
Appendix L	Statistics on Complaints, Notifications of Summons and Successful Prosecutions

EXECUTIVE SUMMARY

The proposed widening of Tolo Highway and Fanling Highway between Island House Interchange and Fanling (the Project) is a Designated Project under the Environmental Impact Assessment Ordinance (Cap. 499) (EIAO). An Environmental Impact Assessment (EIA) Report (the approved EIA Report) together with an Environmental Monitoring and Audit (EM&A) Manual (the approved EM&A Manual) were completed and approved under the EIAO on 14 July 2000 (Register Number: EIA-043/2000).

The objective of the Project “Widening of Tolo Highway / Fanling Highway between Island House Interchange and Fanling” is to widen Tolo Highway and Fanling Highway to dual 4-lane carriageway in order to alleviate the current traffic congestion problems and to cope with the increasing transport demands to and from the urban areas and also cross boundary traffic.

The Project is a designated project and governed by an Environmental Permit (EP-324/2008) issued by the EPD on 23 December 2008. Subsequently, the EPD issued Variation of Environmental Permits of EP-324/2008/A, EP-324/2008/B, EP-324/2008/C and EP-324/2008/D on 31 January 2012, 17 March 2014, 27 March 2015 and 27 August 2015 respectively. The current valid VEP was applied on 29 December 2016 and the VEP (EP-324/2008/E) was subsequently granted on 26 January 2017.

The construction works for this Project are delivered in 2 stages i.e. Stage 1 (between Island House Interchange and Tai Hang) and Stage 2 (between Tai Hang and Wo Hop Shek Interchange). Stage 2 would be implemented under three works contracts. Contract No. HY/2012/06 “Widening of Fanling Highway – Tai Hang to Wo Hop Shek Interchange” and the entrusted portion to CEDD under Contract No. CV/2012/09 “Liantang/Heung Yuen Wai Boundary Control Point Site Formation and Infrastructure Works – Contract 3”. In addition, Contract No. “Provision of Bus-Bus Interchange on Fanling Highway Kowloon Bound” was carried out within the site boundary of Contract No. 02/HY/2015. This report focuses on Contract No. HY/2012/06 “Widening of Fanling Highway – Tai Hang to Wo Hop Shek Interchange” in Stage 2 of the Project and “Provision of Bus-Bus Interchange on Fanling Highway Kowloon Bound” under Works Order Nos. CB128520-5 and CB128519-0 in Contract No. 02/HY/2015 “Highway Department Term Contract (Management and Maintenance of Roads in Tai Po and North District excluding High Speed Roads 2016-2022)”. The construction works of Works Order Nos. CB128520-5 and CB128519-0 under Contract No. 02/HY/2015 have been completed on 23 May 2018.

Pursuant to the EP (EP-324/2008/E) Condition 2.7, the Capture Survey Trip Report for Ma Wat River Northern Meander (Version 2) for the Project was submitted on 24 December 2013 by the Environmental Team (ET) and verified by the Independent Environmental Checker (IEC) on 6 January 2014.

The construction phase of the Contract under the EP and the Environmental Monitoring and Audit (EM&A) programme of the contract commenced on 21 November 2013. The impact environmental monitoring and audit includes air quality and noise monitoring.

This report documents the findings of EM&A works conducted in the period between 1 and 31 March 2021. As informed by the Contractor, construction activities of Contract No. HY/2012/06 in the reporting period were:

- Minor excavation for utility
- Backfilling
- Road resurfacing
- Landscape works
- Demolition of site office
- Sign gantry modification
- Laying of crossroad duct

Reporting Change

There was no reporting change required in the reporting period.

Breaches of Action and Limit Levels for Air Quality

No exceedance of Action and Limit Level was recorded for 1-hour and 24-hour TSP monitoring in the reporting period.

Breaches of Action and Limit Levels for Noise

No Action or Limit Level exceedance of construction noise was recorded in the reporting month. No noise complaints related to 0700 – 1900 hours on normal weekdays was received and followed by Environmental Team in the reporting month.

Complaint, Notification of Summons and Successful Prosecution

No complaint, notification of summons and successful prosecution was received in the reporting period.

Future Key Issues

Key issues to be considered in the coming month include:

- Properly store and label oils and chemicals on site;
- Chemical, chemical waste and waste management;
- Collection of construction waste should be carried out regularly;
- Properly maintain all drainage facilities and wheel washing facilities on site;
- Exposed slopes should be covered up properly if no temporary work will be conducted;
- Quieter powered mechanical equipment should be used;
- Suppress dust generated from excavation activities and haul road traffic; and
- Tree protective measures for all retained trees should be well maintained.

1 INTRODUCTION

1.1 Background

- 1.1.1. Tolo Highway and Fanling Highway are the expressways in the North East New Territories (NENT) connecting Sha Tin, Tai Po and Fanling. These highways form a vital part of the strategic Route 9, which links Hong Kong Island to the boundary at Shenzhen. At present, this section of Route 9 is a dual 3-lane carriageway. However, at several major interchanges along this section of Route 9, the highway is a dual-2 lane carriageway only. Severe congestion is a frequent occurrence during the peak periods, particularly in the Kowloon-bound direction.
- 1.1.2. The objective of the Project “Widening of Tolo Highway / Fanling Highway between Island House Interchange and Fanling” is to widen Tolo Highway and Fanling Highway to dual 4-lane carriageway in order to alleviate the current traffic congestion problems and to cope with the increasing transport demands to and from the urban areas and also cross boundary traffic.
- 1.1.3. The Project is a designated project and governed by an Environmental Permit (EP-324/2008) issued by the EPD on 23 December 2008. Subsequently, the EPD issued Variation of Environmental Permits of EP-324/2008/A, EP-324/2008/B, EP-324/2008/C and EP-324/2008/D on 31 January 2012, 17 March 2014, 27 March 2015 and 27 August 2015 respectively. The current valid VEP was applied on 29 December 2016 and the VEP (EP-324/2008/E) was subsequently granted on 26 January 2017.
- 1.1.4. The scope of the Project comprises mainly:
- (i) Widening of a 5.7 km section of Tolo Highway and 3.0 km section of Fanling Highway between Island House Interchange and Wo Hop Shek Interchange from the existing dual 3-lane to dual 4-lane, including construction of new vehicular bridges;
 - (ii) Widening of interchange sections at Island House Interchange, Tai Po North Interchange, and Lam Kam Road Interchange from dual 2-lane to dual 3-lane, except Sha Tin bound carriageway at Tai Po North Interchange, which is widened from 3-lane to 4-lane, including realignment of various slip roads;
 - (iii) Modification and reconstruction of highways, vehicular bridges, underpasses and footbridges.
- 1.1.5. The construction works for this Project will be delivered in 2 stages i.e. Stage 1 (between Island House Interchange and Tai Hang) and Stage 2 (between Tai Hang and Wo Hop Shek Interchange). Stage 2 would be implemented under two works contracts. Contract No. HY/2012/06 “Widening of Fanling Highway – Tai Hang to Wo Hop Shek Interchange” and the entrusted portion to CEDD under Contract No. CV/2012/09 “Liantang/Heung Yuen Wai Boundary Control Point Site Formation and Infrastructure Works – Contract 3”. In addition, Contract No. “Provision of Bus-Bus Interchange on Fanling Highway Kowloon Bound” was carried out within the site boundary of Contract No. 02/HY/2015. This report focuses on Contract No. HY/2012/06 “Widening of Fanling Highway – Tai Hang to Wo Hop Shek Interchange” in Stage 2 of the Project and “Provision of Bus-Bus Interchange on Fanling Highway Kowloon Bound” under Works Order Nos. CB128520-5 and CB128519-0 in Contract No. 02/HY/2015 “Highway Department Term Contract (Management and Maintenance of Roads in Tai Po and North District excluding High Speed Roads 2016-2022)”.
- 1.1.6. Hyder-Arup-Black and Veatch Joint Venture (HABVJV) are appointed by Highways Department (HyD) as the consultants for the design and construction assignment for the Tolo project under Agreement No. CE 58/2000 Supplementary Agreement No. 3 (SA3) (i.e. the Engineer for Contract No. HY/2012/06).
- 1.1.7. China State Construction Engineering (Hong Kong) Ltd. (CSHK) was commissioned as the Contractor of Contract No. HY/2012/06. Chiu Hing Construction & Transportation Company Limited (Chiu Hing) was commissioned as the Contractor of Contract No. 02/HY/2015. The construction works of Works Order Nos. CB128520-5 and CB128519-0 under Contract No. 02/HY/2015 have been completed on 23 May 2018.

1.1.8. AECOM Asia Co. Ltd. was commissioned by China State Construction Engineering (Hong Kong) Limited as the Environmental Team (ET) to undertake the Environmental Monitoring and Audit (EM&A) works for the Contract and Mott MacDonald Hong Kong Ltd. acts as the Independent Environmental Checker (IEC) for the Contract.

1.1.9. The construction phase of the Contract under the EP commenced on 21 November 2013.

1.1.10. According to the updated EM&A Manual of Stage 2 of the Project, there is a need of an EM&A programme including air quality and noise monitoring. The EM&A programme for Stage 2 of the Project commenced on 21 November 2013.

1.2 Scope of Report

1.2.1 This is the ninetieth monthly EM&A Report under the Contract No. HY/2012/06 “Widening of Fanling Highway – Tai Hang to Wo Hop Shek Interchange”. This report presents a summary of the environmental monitoring and audit works, list of activities and mitigation measures proposed by the ET for the Contract in March 2021.

1.3 Project Organization

1.3.1 The project organization structure is shown in Appendix A. The key personnel contact names and numbers are summarized in Table 1.1.

Table 1.1 Contact Information of Key Personnel

Party	Position	Name	Telephone	Fax
ER (Hyder-Arup-Black & Veatch Joint Venture)	Chief Resident Engineer	Raymond Ho	6115 0818	2638 0950
IEC (Mott MacDonald Hong Kong Limited)	Independent Environmental Checker	Steven Tang	2828 5920	2827 1823
Contractor of [HY/2012/06] (China State Construction Engineering (Hong Kong) Limited)	Environmental Officer	Michael Tsang	9277 4956	2672 2501
		C C Chow	9679 6315	2672 2501
Contractor of [02/HY/2015] (Chiu Hing Construction & Transportation Company Limited)	Safety Officer	Marty Tai	9106 5318	-

Party	Position	Name	Telephone	Fax
ET (AECOM Asia Company Limited)	ET Leader	Y W Fung	3922 9393	3922 9797

1.4 Summary of Construction Works

- 1.4.1 The construction phase for the Contract under the EP commenced on 21 November 2013.
- 1.4.2 Details of the construction works of Contract No. HY/2012/06 carried out by the Contractor in this reporting period are listed below:
- Minor excavation for utility
 - Backfilling
 - Road resurfacing
 - Landscape works
 - Demolition of site office
 - Sign gantry modification
 - Laying of crossroad duct
- 1.4.3 The Construction Programme is shown in Appendix B.
- 1.4.4 The general layout plan of the Project site of Contract No. HY/2012/06 and Works Order Nos. CB128520-5 and CB128519-0 under 02/HY/2015 showing the contract areas are shown in Figure 1.1 and Figure 1.2 respectively.
- 1.4.5 The environmental mitigation measures implementation schedule are presented in Appendix C .

1.5 Summary of EM&A Programme Requirements

- 1.5.1 The EM&A programme required environmental monitoring for air quality, noise and environmental site inspections for air quality, water quality, noise, waste management, ecology, and landscape and visual impact. The EM&A requirements for each parameter described in the following sections include:-
- All monitoring parameters;
 - Monitoring schedules for the reporting period and forthcoming months;
 - Action and Limit levels for all environmental parameters;
 - Event / Action Plan;
 - Environmental mitigation measures, as recommended in the Project EIA study final report; and
 - Environmental requirement in contract documents.

2 AIR QUALITY MONITORING

2.1 Monitoring Requirements

2.1.1 In accordance with the updated EM&A Manual, baseline 1-hour and 24-hour TSP levels at one air quality monitoring station was established. Impact 1-hour TSP monitoring was conducted for at least three times every 6 days, while impact 24-hour TSP monitoring was carried out for at least once every 6 days. The Action and Limit level of the air quality monitoring is provided in Appendix D.

2.2 Monitoring Equipment

2.2.1 24-hour TSP air quality monitoring was performed using High Volume Sampler (HVS) located at each designated monitoring station. The HVS meets all the requirements of the updated EM&A Manual. Portable direct reading dust meters were used to carry out the 1-hour TSP monitoring. Brand and model of the equipment is given in Table 2.1.

Table 2.1 Air Quality Monitoring Equipment

Equipment	Brand and Model
Portable direct reading dust meter (1-hour TSP)	Sibata Digital Dust Monitor (Model No. LD-3)
High Volume Sampler (24-hour TSP)	Tisch Total Suspended Particulate Mass Flow Controlled High Volume Air Sampler (Model No. TE-5170)

2.3 Monitoring Locations

2.3.1 The monitoring station was set up at the proposed location in accordance with updated EM&A Manual. Table 2.2 describes details of the monitoring station. The locations are shown in Figure 1.3a.

Table 2.2 Locations of Impact Air Quality Monitoring Station

Location	Monitoring Station
AM2 (SR2)	Fanling Government Secondary School

2.4 Monitoring Parameters and Frequency

2.4.1 Table 2.3 summarizes the monitoring parameters, frequency and duration of impact TSP monitoring.

Table 2.3 Air Quality Monitoring Parameters and Frequency

Parameter	Frequency
24-hour TSP	Once every 6 days
1-hour TSP	3 times every 6 days while the highest dust impact was expected

2.5 Monitoring Methodology

2.5.1 24-hour TSP Monitoring

- (a) The HVS was installed in the vicinity of the air sensitive receivers. The following criteria were considered in the installation of the HVS.
- (i) A horizontal platform with appropriate support to secure the sampler against gusty wind was provided.
 - (ii) The distance between the HVS and any obstacles, such as buildings, was at least twice the height that the obstacle protrudes above the HVS.
 - (iii) A minimum of 2 meters separation from walls, parapets and penthouse for rooftop sampler.
 - (iv) A minimum of 2 meters separation from any supporting structure, measured horizontally.
 - (v) No furnace or incinerator flues nearby.
 - (vi) Airflow around the sampler was unrestricted.
 - (vii) Permission was obtained to set up the samplers and access to the monitoring stations.
 - (viii) A secured supply of electricity was obtained to operate the samplers.
 - (ix) The sampler was located more than 20 meters from any dripline.
 - (x) Any wire fence and gate, required to protect the sampler, did not obstruct the monitoring process.
 - (xi) Flow control accuracy was kept within $\pm 2.5\%$ deviation over 24-hour sampling period.
- (b) Preparation of Filter Papers
- (i) Glass fibre filters, G810 were labelled and sufficient filters that were clean and without pinholes were selected.
 - (ii) All filters were equilibrated in the conditioning environment for 24 hours before weighing. The conditioning environment temperature was around 25 °C and not variable by more than ± 3 °C; the relative humidity (RH) was < 50% and not variable by more than $\pm 5\%$. A convenient working RH was 40%.
 - (iii) All filter papers were prepared and analysed by ALS Technichem (HK) Pty Ltd., which is a HOKLAS accredited laboratory and has comprehensive quality assurance and quality control programmes.
- (c) Field Monitoring
- (i) The power supply was checked to ensure the HVS works properly.
 - (ii) The filter holder and the area surrounding the filter were cleaned.
 - (iii) The filter holder was removed by loosening the four bolts and a new filter, with stamped number upward, on a supporting screen was aligned carefully.
 - (iv) The filter was properly aligned on the screen so that the gasket formed an airtight seal on the outer edges of the filter.
 - (v) The swing bolts were fastened to hold the filter holder down to the frame. The pressure applied was sufficient to avoid air leakage at the edges.
 - (vi) Then the shelter lid was closed and was secured with the aluminum strip.
 - (vii) The HVS was warmed-up for about 5 minutes to establish run-temperature conditions.
 - (viii) A new flow rate record sheet was set into the flow recorder.
 - (ix) On site temperature and atmospheric pressure readings were taken and the flow rate of the HVS was checked and adjusted at around 1.1 m³/min, and complied with the range specified in the updated EM&A Manual (i.e. 0.6-1.7 m³/min).
 - (x) The programmable digital timer was set for a sampling period of 24 hrs, and the starting time, weather condition and the filter number were recorded.
 - (xi) The initial elapsed time was recorded.
 - (xii) At the end of sampling, on site temperature and atmospheric pressure readings were taken and the final flow rate of the HVS was checked and recorded.
 - (xiii) The final elapsed time was recorded.

- (xiv) The sampled filter was removed carefully and folded in half-length so that only surfaces with collected particulate matter were in contact.
 - (xv) It was then placed in a clean plastic envelope and sealed.
 - (xvi) All monitoring information was recorded on a standard data sheet.
 - (xvii) Filters were then sent to ALS Technichem (HK) Pty Ltd. for analysis.
- (d) Maintenance and Calibration
- (i) The HVS and its accessories were maintained in good working condition, such as replacing motor brushes routinely and checking electrical wiring to ensure a continuous power supply.
 - (ii) 5-point calibration of the HVS was conducted using TE-5025A Calibration Kit prior to the commencement of baseline monitoring. Bi-monthly 5-point calibration of the HVS will be carried out during impact monitoring.
 - (iii) Calibration certificate of the HVSs are provided in Appendix E.

2.5.2 1-hour TSP Monitoring

(a) Measuring Procedures

The measuring procedures of the 1-hour dust meter were in accordance with the Manufacturer's Instruction Manual as follows:

- (i) Turn the power on.
- (ii) Close the air collecting opening cover.
- (iii) Push the "TIME SETTING" switch to [BG].
- (iv) Push "START/STOP" switch to perform background measurement for 6 seconds.
- (v) Turn the knob at SENSI ADJ position to insert the light scattering plate.
- (vi) Leave the equipment for 1 minute upon "SPAN CHECK" is indicated in the display.
- (vii) Push "START/STOP" switch to perform automatic sensitivity adjustment. This measurement takes 1 minute.
- (viii) Pull out the knob and return it to MEASURE position.
- (ix) Push the "TIME SETTING" switch the time set in the display to 3 hours.
- (x) Lower down the air collection opening cover.
- (xi) Push "START/STOP" switch to start measurement.

(b) Maintenance and Calibration

- (i) The 1-hour TSP meter was calibrated at 1-year intervals against a continuous particulate TEOM Monitor, Series 1400ab. Calibration certificates of the Laser Dust Monitors are provided in Appendix E.
- (ii) 1-hour validation checking of the TSP meter against HVS is carried out yearly at the air quality monitoring locations.

2.6 Monitoring Schedule for the Reporting period

2.6.1 The schedule for environmental monitoring in March 2021 is provided in Appendix F.

2.7 Results and Observations

2.7.1 The monitoring results for 1-hour TSP and 24-hour TSP are summarized in Table 2.4 and 2.5 respectively. Detailed impact air quality monitoring results are presented in Appendix G.

Table 2.4 Summary of 1-hour TSP Monitoring Results in the Reporting Period

Location	Average ($\mu\text{g}/\text{m}^3$)	Range ($\mu\text{g}/\text{m}^3$)	Action Level ($\mu\text{g}/\text{m}^3$)	Limit Level ($\mu\text{g}/\text{m}^3$)
AM2 (Fanling Government Secondary School)	57.7	51.9 – 63.5	317.8	500

Table 2.5 Summary of 24-hour TSP Monitoring Results in the Reporting Period

Location	Average ($\mu\text{g}/\text{m}^3$)	Range ($\mu\text{g}/\text{m}^3$)	Action Level ($\mu\text{g}/\text{m}^3$)	Limit Level ($\mu\text{g}/\text{m}^3$)
AM2 (Fanling Government Secondary School)	46.7	27.4 – 83.1	200.7	260

2.7.2 The major dust source during the monitoring was mainly from nearby traffic emission.

2.7.3 All 1-hour and 24-hour TSP results were below the Action and Limit Level at all monitoring locations in the reporting period.

2.7.4 The event action plan is annexed in Appendix J.

2.7.5 Weather information including wind speed and wind direction is annexed in Appendix H. The information was obtained from the Hong Kong Observatory Tai Po and Tai Mei Tuk Automatic Weather Stations.

3 NOISE MONITORING

3.1 Monitoring Requirements

3.1.1 In accordance with the EM&A Manual, impact noise monitoring was conducted for at least once per week during the construction phase of the Contract. The Action and Limit level of the noise monitoring is provided in Appendix D.

3.2 Monitoring Equipment

3.2.1 Noise monitoring was performed using sound level meter at each designated monitoring station. The sound level meters deployed comply with the International Electrotechnical Commission Publications (IEC) 651:1979 (Type 1) and 804:1985 (Type 1) specifications. Acoustic calibrator was deployed to check the sound level meters at a known sound pressure level. Brand and model of the equipment is given in Table 3.1.

Table 3.1 Noise Monitoring Equipment

Equipment	Brand and Model
Integrated Sound Level Meter	B&K 2238 / 2270
Acoustic Calibrator	B&K 4231

3.3 Monitoring Locations

3.3.1 Monitoring stations M2 and M3 were set up at the proposed locations in accordance with updated EM&A Manual. Figure 1.3a-b shows the locations of the monitoring stations. Table 3.2 describes the details of the monitoring stations.

Table 3.2 Locations of Impact Noise Monitoring Stations

Monitoring Station	Location	Description
M2	West Tai Wo	1.2m from the ground floor free-field of the Residential
M3	Fanling Government Secondary School	1m from the exterior of the roof top façade of the school

3.4 Monitoring Parameters and Frequency

3.4.1 Table 3.3 summarizes the monitoring parameters, frequency and duration of impact noise monitoring.

Table 3.3 Noise Monitoring Parameters, Frequency and Duration

Parameter	Frequency
30-mins measurement at each monitoring station between 0700 and 1900 on normal weekdays. L_{eq} , L_{10} and L_{90} would be recorded.	At least once per week

3.5 Monitoring Methodology

3.5.1 Monitoring Procedure

- (a) Façade measurement was made at monitoring station M3, while free-field measurement was made at monitoring station M2.
- (b) The sound level meter was set on a tripod at a height of 1.2 m above the ground for free-field measurements at monitoring station M2.
- (c) The battery condition was checked to ensure the correct functioning of the meter.
- (d) Parameters such as frequency weighting, the time weighting and the measurement time were set as follows:
 - (i) frequency weighting: A
 - (ii) time weighting: Fast
 - (iii) time measurement: $L_{eq(30\text{-minutes})}$ during non-restricted hours i.e. 07:00 – 1900 on normal weekdays; $L_{eq(5\text{-minutes})}$ during restricted hours i.e. 19:00 – 23:00 and 23:00 – 07:00 of normal weekdays, whole day of Sundays and Public Holidays
- (e) Prior to and after each noise measurement, the meter was calibrated using the acoustic calibrator for 94dB(A) at 1000 Hz. If the difference in the calibration level before and after measurement was more than 1 dB(A), the measurement would be considered invalid and repeat of noise measurement would be required after re-calibration or repair of the equipment.
- (f) During the monitoring period, the L_{eq} , L_{10} and L_{90} were recorded. In addition, site conditions and noise sources were recorded on a standard record sheet.
- (g) Noise measurement was paused during periods of high intrusive noise (e.g. dog barking, helicopter noise) if possible. Observations were recorded when intrusive noise was unavoidable.
- (h) Noise monitoring was cancelled in the presence of fog, rain, wind with a steady speed exceeding 5m/s, or wind with gusts exceeding 10m/s.

3.5.2 Maintenance and Calibration

- (a) The microphone head of the sound level meter was cleaned with soft cloth at regular intervals.
- (b) The meter and calibrator were sent to the supplier or HOKLAS laboratory to check and calibrate at yearly intervals.
- (c) Calibration certificates of the sound level meters and acoustic calibrators are provided in Appendix E.

3.6 Monitoring Schedule for the Reporting period

3.6.1 The schedule for environmental monitoring in March 2021 is provided in Appendix F.

3.7 Monitoring Results

3.7.1 The monitoring results for construction noise are summarized in Table 3.4 and the monitoring data is provided in Appendix I.

Table 3.4 Summary of Construction Noise Monitoring Results in the Reporting Period

Location	Average, dB(A), L_{eq} (30 mins)	Range, dB(A), L_{eq} (30 mins)	Limit Level, dB(A), L_{eq} (30 mins)
M2* (West Tai Wo)	64.3	59.2 – 67.1	75
M3# (Fanling Government Secondary School)	62.8	60.2 – 65.8	65/70

*+3dB(A) Façade correction included

Limit Level of 70dB(A) applies to education institutes while 65dB(A) applies during school examination period.

3.7.2 No Action or Limit Level exceedance of construction noise was recorded in the reporting month. No noise complaints related to 0700 – 1900 hours on normal weekdays was received and followed by Environmental Team in the reporting month.

3.7.3 Major noise sources during noise monitoring in the reporting period were mainly road traffic noise.

3.7.4 The event action plan is annexed in Appendix J.

4 ENVIRONMENTAL SITE INSPECTION AND AUDIT

4.1 Site Inspection

4.1.1 Site Inspections were carried out on a weekly basis to monitor the implementation of proper environmental pollution control and mitigation measures for the Contract. In the reporting period, 5 site inspections were carried out respectively on 2, 9, 16, 23 and 31 March 2021 for the Contract. While no specific observation was recorded, recommendations on remedial actions were given to the Contractor for precautionary purpose.

4.1.2 The environmental site inspections summaries are provided in Appendix K.

4.1.3 Particular observations during the site inspections are described below:

Contract No. HY/2012/06

Air Quality

4.1.4 No adverse observation was identified in the reporting period.

Noise

4.1.5 No adverse observation was identified in the reporting period.

Water Quality

4.1.6 No adverse observation was identified in the reporting period.

Chemical and Waste Management

4.1.7 Chemical waste containers stored without drip tray was observed at demolishing site office. The Contractor was advised to provide a drip tray to the chemical waste containers stored onsite.

Landscape and Visual Impact

4.1.8 No adverse observation was identified in the reporting period.

Miscellaneous

4.1.9 No adverse observation was identified in the reporting period.

4.2 Advice on the Solid and Liquid Waste Management Status

- 4.2.1 Contract No. HY/2012/06 has registered as chemical waste producers for the Contract. C&D material sorting was carried out on site. Sufficient numbers of receptacles were available for general refuse collection.
- 4.2.2 As advised by the Contractor of Contract No. HY/2012/06, 67 m³ of inert C&D material was generated in the reporting month (14 m³ disposed of as public fill to Tuen Mun 38, 38 m³ of inert C&D materials was reused on site, 0 m³ of inert C&D materials was reused in other projects and 15 m³ was broken concrete). For C&D wastes, 180 m³ of general refuse was disposed of at NENT landfill, 0 kg of paper/cardboard packaging, 0 kg of plastics and 0 kg of metals were collected by recycling Contractors, and 0 kg of chemical wastes was collected by licensed Contractors in the reporting period.
- 4.2.3 The actual amounts of different types of waste generated by the activities of the Project in the reporting period are shown in Table 4.1.

Table 4.1 Summary of Waste Flow Table for Contract No. HY/2012/06

Waste Type	Actual Amount	Disposal/Reuse Locations
Inert C&D materials disposed as public fill	14 m ³	Tuen Mun 38
Broken concrete	15 m ³	Tuen Mun 38
C&D wastes disposed as general refuse	180 m ³	NENT Landfill
Paper/cardboard packaging	0 kg	Recycling Facilities
Plastics	0 kg	Recycling Facilities
Metals	0 kg	Recycling Facilities
C&D materials reused on site	38 m ³	Site Area
C&D materials reused in other projects	0 m ³	Other projects
Chemical wastes	0 kg	Licensed Contractors

- 4.2.4 The Contractors were advised to maintain on-site waste sorting and recording system and maximize reuse / recycle of C&D wastes.

4.3 Environmental Licenses and Permits

4.3.1 The environmental licenses and permits for Stage 2 of the Project and valid in the reporting period is summarized in Table 4.2.

Table 4.2 Summary of Environmental Licensing and Permit Status

Statutory Reference	License/ Permit	License or Permit No.	Valid Period		License / Permit Holder	Remarks
			From	To		
EIAO	Environment al Permit	EP-324/2008/E	26/01/2017	N/A	HyD	
WPCO	Discharge License (Site)	WT-00031556-2018	20/09/2018	30/09/2023	CSHK	--
		WT00027968-2017	22/05/2017	31/05/2022	Chiu Hing	--
WDO	Chemical Waste Producer Registration	5213-722-C3822-01	05/09/2013	N/A	CSHK	Chemical waste produced in Contract HY/2012/06
WDO	Billing Account for Disposal of Construction Waste	7017860	N/A	N/A	CSHK	Waste disposal in Contract HY/2012/06
		7024392	N/A	N/A	Chiu Hing	Waste disposal in Contract 02/HY/2015
APCO	Notification Under Air Pollution Control (Construction Dust) Regulation	361991	15/07/2013	N/A	CSHK	--
		414360	08/03/2017	N/A	Chiu Hing	--
NCO	Construction Noise Permit	RW-RN0910-20	22/12/2020	28/3/2021	CSHK	Removal of traffic sign and concreting works Zone 4
		GW-RN0066-21	2/11/2021	3/31/2021	CSHK	Road Resurfacing in Zone 4
		GW-RN0910-20	2/17/2021	3/28/2021	CSHK	Road Resurfacing in Zone 1 & 2
		GW-RN0100-21	2/22/2021	3/31/2021	CSHK	Installation of Crossroad Dust at PWR
		GW-RN0102-21	2/22/2021	3/31/2021	CSHK	Modification of Sign Gantry Zone1&2

4.4 Implementation Status of Environmental Mitigation Measures

4.4.1 A summary of the Implementation Schedule of Environmental Mitigation Measures (EMIS) is presented in Appendix C.

4.5 Summary of Exceedances of the Environmental Quality Performance Limit

4.5.1 All 1-hour and 24-hour TSP monitoring results complied with the Action / Limit Levels in the reporting period.

4.5.2 No Action or Limit Level exceedance of construction noise was recorded in the reporting month. No noise complaints related to 0700 – 1900 hours on normal weekdays was received and followed by Environmental Team in the reporting month.

4.6 Summary of Complaints, Notification of Summons and Successful Prosecutions

4.6.1 The Environmental Complaint Handling Procedure is annexed in Figure 4.1.

4.6.2 No complaint, notification of summons and successful prosecution was received in the reporting period.

4.6.3 Statistics on complaints, notifications of summons and successful prosecutions are summarized in Appendix L.

5 FUTURE KEY ISSUES

5.1 Construction Programme for the Coming Months

5.1.1 The major construction works for Contract No. HY/2012/06 in April 2021 will be:

- Minor excavation for utility
- Backfilling
- Road resurfacing
- Landscape works
- Sign gantry modification
- Laying of crossroad duct

5.2 Key Issues for the Coming Month

5.2.1 Key issues to be considered in April 2021:

- Properly store and label oils and chemicals onsite;
- Chemical, chemical waste and waste management;
- Collection of construction waste should be carried out regularly;
- Properly maintain all drainage facilities and wheel washing facilities on site;
- Exposed slopes should be covered up properly if no temporary work will be conducted;
- Quieter powered mechanical equipment should be used;
- Suppress dust generated from excavation activities and haul road traffic; and
- Tree protective measures for all retained trees should be well maintained.

5.3 Monitoring Schedule for the Coming Month

5.3.1 The tentative schedule for environmental monitoring in April 2021 is provided in Appendix F.

6 CONCLUSIONS AND RECOMMENDATIONS

6.1 Conclusions

- 6.1.1 The construction phase and EM&A programme of the Contract commenced on 21 November 2013.
- 6.1.2 All 1-hour and 24-hour TSP monitoring results complied with the Action / Limit Levels in the reporting period.
- 6.1.3 No Action or Limit Level exceedance of construction noise was recorded in the reporting month. No noise complaints related to 0700 – 1900 hours on normal weekdays was received and followed by Environmental Team in the reporting month.
- 6.1.4 5 environmental site inspections were carried out in March 2021. Recommendations on remedial actions were given to the Contractors for the deficiencies identified during the site audits.
- 6.1.5 No complaint, notification of summons and successful prosecution was received in the reporting period.

6.2 Recommendations

- 6.2.1 According to the environmental site inspections performed in the reporting period, the following recommendations on remedial actions were provided to the Contractor for precautionary purpose:

Contract No. HY/2012/06

Air Quality

- 6.2.2 No adverse observation was identified in the reporting period.

Noise

- 6.2.3 No adverse observation was identified in the reporting period.

Water Quality

- 6.2.4 No adverse observation was identified in the reporting period.

Chemical and Waste Management

- 6.2.5 The Contractor was advised to provide a drip tray to the chemical container stored onsite.

Landscape and Visual Impact

- 6.2.6 No adverse observation was identified in the reporting period.

Miscellaneous

- 6.2.7 No adverse observation was identified in the reporting period.

FIGURES

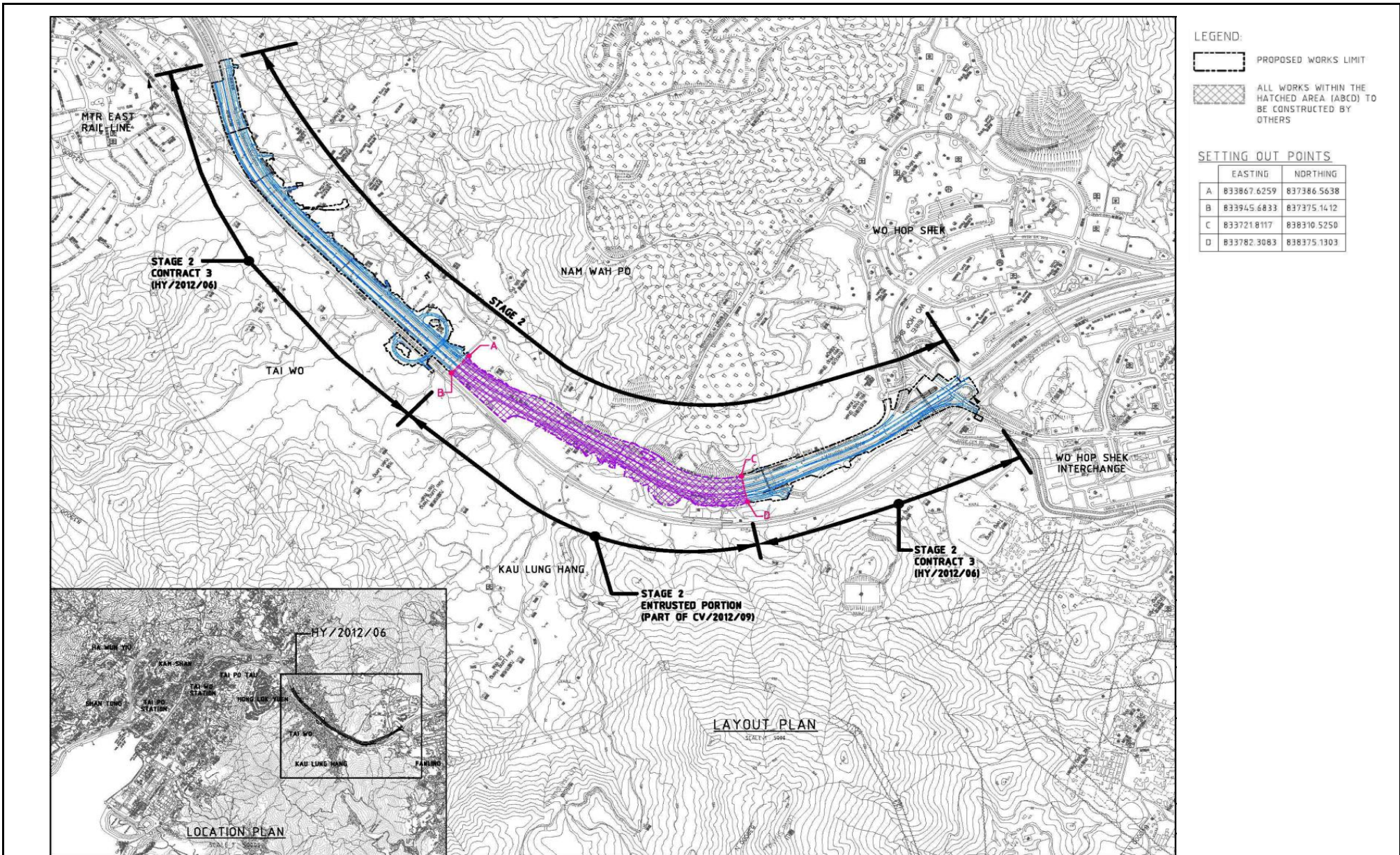

This Drawing has been prepared for the use of AECOM's client. It may not be used, modified, reproduced or relied upon by third parties, except as agreed by AECOM or as required by law. AECOM accepts no responsibility, and denies any liability whatsoever, to any party that uses or relies on this drawing without AECOM's express written consent.

CONTRACT NO. HY/2012/06
 WIDENING OF FANLING HIGHWAY
 - TAI HANG TO WO HOP SHEK INTERCHANGE



Layout Plan

Date: Dec 2013

Figure 1.1

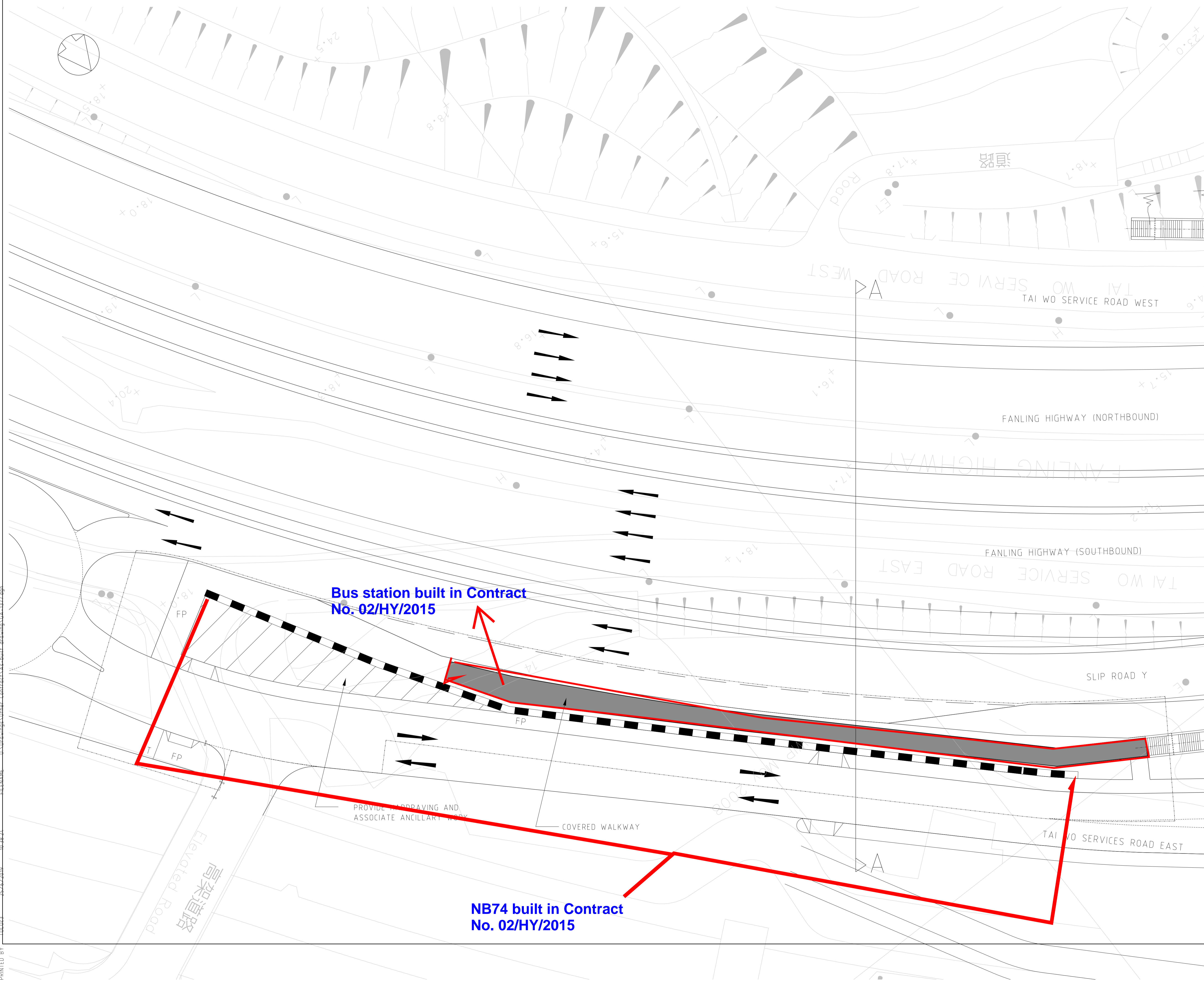

- LEGENDS :**
- LIMIT OF WORKS AREA
 - VERTICAL NOISE BARRIER 6m HIGH
 - COVERED WALKWAY
 - FOOTPATH
 - CYCLE TRACK

Z	OCT2018	AS-BUILT DRAWING	EC	JP
REV	DATE	DESCRIPTION	CHECKED	APP
修訂	日期	內容摘要	覆核	批覆人
REVISION				
DESIGNED	RL	CHECKED	EC	
繪圖	YKN	覆核	-	
APPROVED FOR ISSUE	JP	© Copyright Reserved		
批覆人	JP	版權所 有		
DATE	JUL. 2017	All dimensions are in mm unless shown otherwise		
日期	JUL. 2017	No measurement should be taken from drawing directly		
SCALE	AS SHOWN			
比例	AS SHOWN			
CAD REF	A1 = 1250			
檔案名稱	A3 = 1300			

路政署
HIGHWAYS DEPARTMENT
 主要工程管理處
 MAJOR WORKS PROJECT MANAGEMENT OFFICE

CONTRACT TITLE
 合約項目
Highways Department Term Contract (Management and Maintenance of Roads in Tai Po and North Districts excluding High Speed Roads 2016-2012)

CONTRACT NO 02/HY/2015

CONSULTANT
 工程顧問
Hyder ARUP BLACK & VEATCH

DRAWING TITLE
 圖名
GENERAL LAYOUT FOR BB1

AS-BUILT DRAWING

DRAWING NO
 圖紙編號
 02/HY/2015/1377

REV
 修訂
 Z

Bus station built in Contract No. 02/HY/2015

NB74 built in Contract No. 02/HY/2015

PROVIDE PAVING AND ASSOCIATE ANCILLARY WORK
 COVERED WALKWAY

PRINTED BY TLOLO-3 25/6/2018 10:38:27 FILENAME: D:\Drawings\Other_Contract\As-built-drawing\GA_1377.dwg

100mm ON ORIGINAL

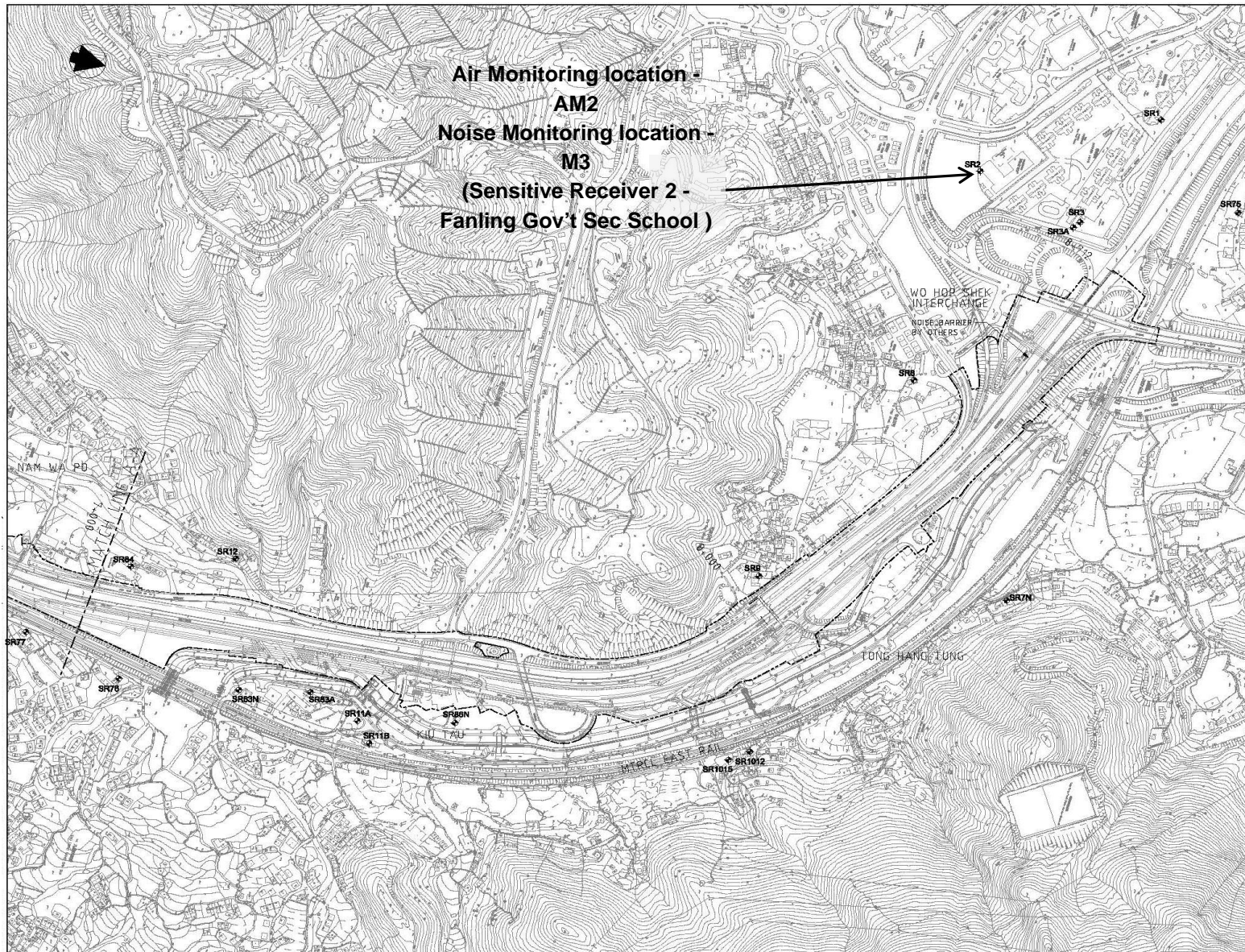

This Drawing has been prepared for the use of AECOM's client. It may not be used, modified, reproduced or relied upon by third parties, except as agreed by AECOM or as required by law. AECOM accepts no responsibility, and denies any liability whatsoever, to any party that uses or relies on this drawing without AECOM's express written consent.

CONTRACT NO. HY/2012/06
WIDENING OF FANLING HIGHWAY
- TAI HANG TO WO HOP SHEK INTERCHANGE



Locations of Monitoring Station

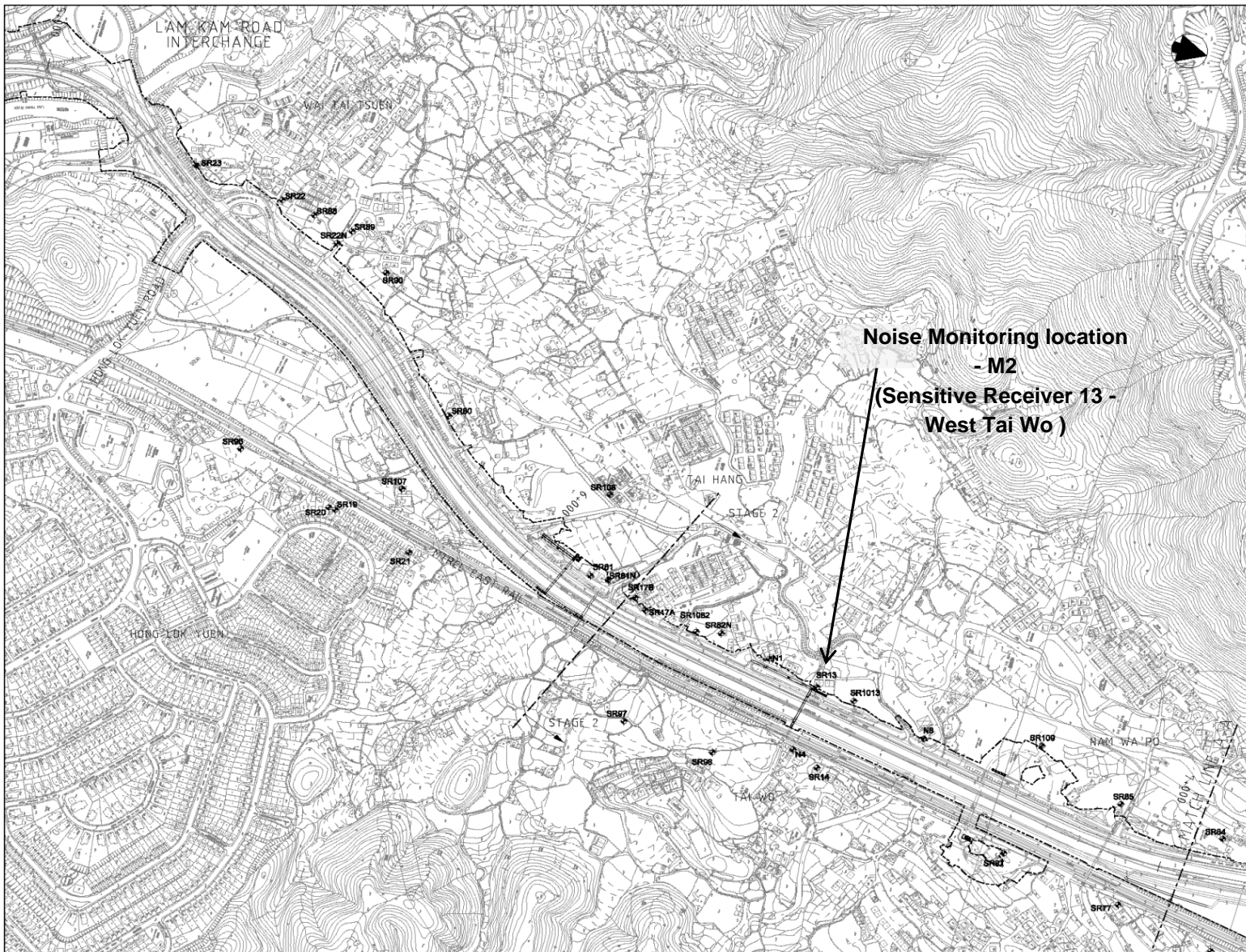

This Drawing has been prepared for the use of AECOM's client. It may not be used, modified, reproduced or relied upon by third parties, except as agreed by AECOM or as required by law. AECOM accepts no responsibility, and denies any liability whatsoever, to any party that uses or relies on this drawing without AECOM's express written consent.

CONTRACT NO. HY/2012/06
 WIDENING OF FANLING HIGHWAY
 - TAI HANG TO WO HOP SHEK INTERCHANGE



Locations of Monitoring Station

Date: Dec 2013

Figure 1.3b

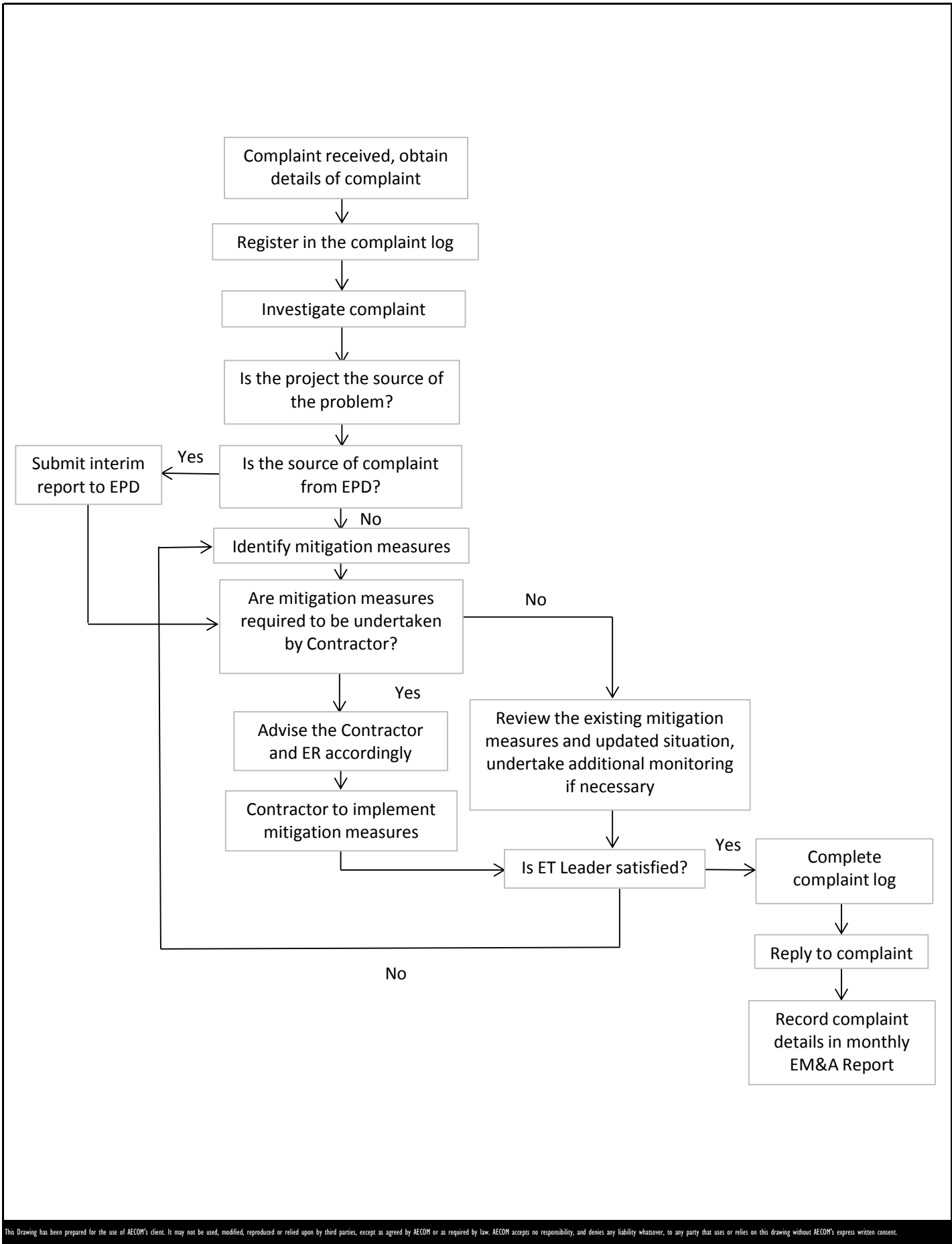

This Drawing has been prepared for the use of AECOM's client. It may not be used, modified, reproduced or relied upon by third parties, except as agreed by AECOM or as required by law. AECOM accepts no responsibility, and denies any liability whatsoever, to any party that uses or relies on this drawing without AECOM's express written consent.

CONTRACT NO. HY/2012/06
 WIDENING OF FANLING HIGHWAY
 - TAI HANG TO WO HOP SHEK INTERCHANGE



Environmental Complaint Handling Procedure

**APPENDIX A
PROJECT ORGANIZATION STRUCTURE**

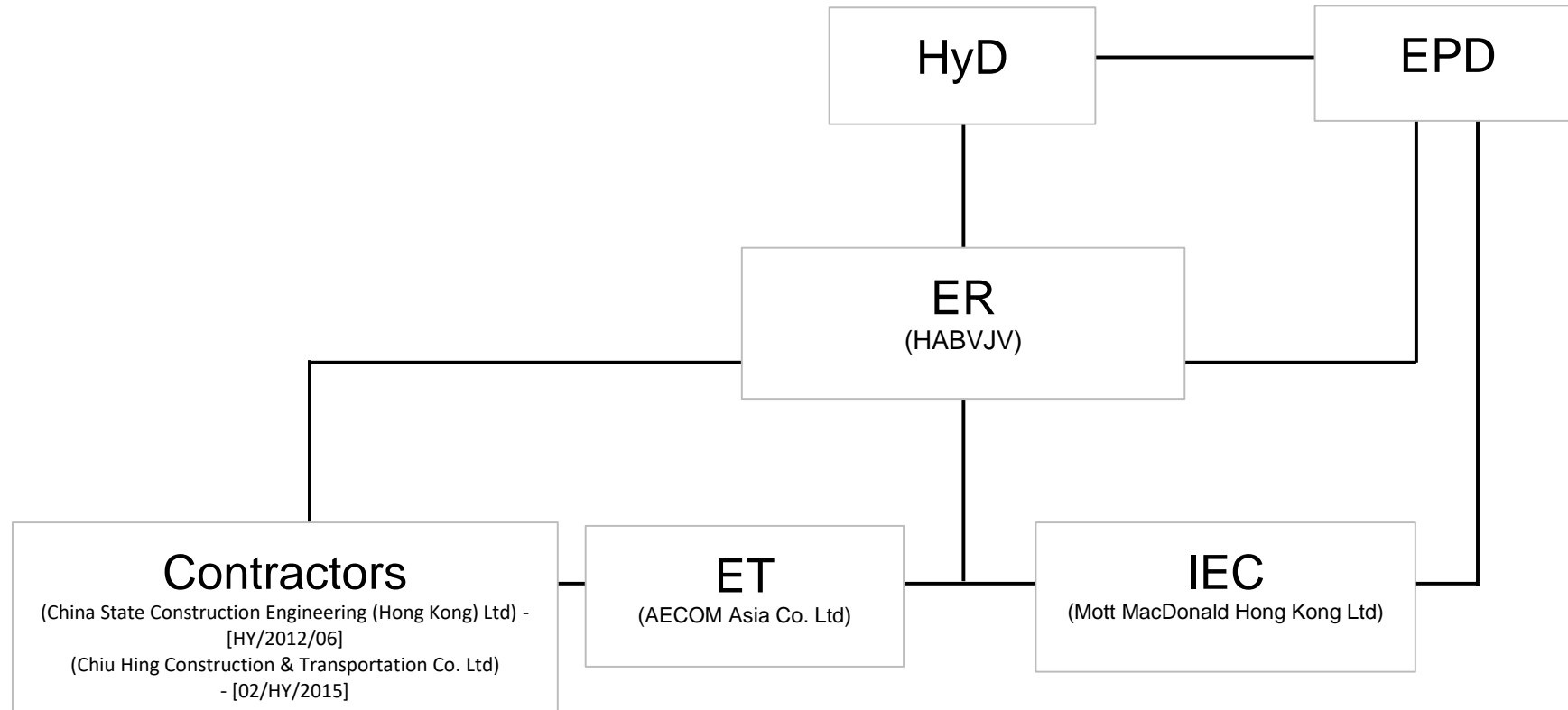

This Drawing has been prepared for the use of AECOM's client. It may not be used, modified, reproduced or relied upon by third parties, except as agreed by AECOM or as required by law. AECOM accepts no responsibility, and denies any liability whatsoever, to any party that uses or relies on this drawing without AECOM's express written consent.

CONTRACT NO. HY/2012/06
 WIDENING OF FANLING HIGHWAY
 - TAI HANG TO WO HOP SHEK INTERCHANGE



Project Organization Structure

**APPENDIX B
CONSTRUCTION PROGRAMMES**

Activity ID	Activity Name	Dur. % Complete	Rem. Duration	Original Duration	Start	Finish	Total Float	2019		2020	
								Nov	Dec	Jan	Feb
ZONE 1 (Ch. 5640 to 5880)											
Other Works											
VO189 - Irrigation System in Zone 1 and Zone 2											
VO189 - Irrigation System in Zone 1 and Zone 2											
IS0120	Irrigation system installation in Zone 1	0%	30	30	20-Nov-19*	24-Dec-19	252				
Establishment Works											
Establishment Works											
Z1.EW.1000	Establishment work Zone1	44.38%	203	365	11-Jun-19 A	09-Jun-20	0				
ZONE 2 (Ch. 5880 to 6930)											
General											
DRM Proposal											
DRM Proposal											
ADVZ20300	TWSR-W lane 2 construction	0%	30	30	27-Dec-19	03-Feb-20	222				
Noise Barrier Along Fanling Highway N/B											
NB43A (Ch.5880-6060)-FH N/B Side											
Noise Barrier Works											
NB03340	Relocate Bus Shelter installation - VO86	0%	11	11	16-Dec-19*	30-Dec-19	249				
Underground Utility Works											
Underground Utility Works											
UU0110	Towgas duct laying and associated work before backfill in Zone 1 & 2	92.72%	41	563	20-Apr-18A	30-Dec-19	187				
UU0130	TTA duct laying and Road reinstatement by Towgas in Zone 1 & 2 (if required)	0%	120	120	31-Dec-19	28-Apr-20	187				
Bridge Construction											
New Tai Hang Footbridge											
General											
THBF0655	Tai Hang Footbridge Complete	0%	0	0		31-Dec-19	248				31-Dec-19 ◆ Tai Hang Footbridge Complete
TWSR-East FL Highway S/B Side Section											
THBF0640	Finishes Work	0%	34	30	25-Sep-19 A	31-Dec-19	248				
THBF0645	Bridge Structure complete (THFB-TWSR-E side)	0%	0	0		31-Dec-19	248				31-Dec-19 ◆ Bridge Structure complete (THFB
THBF0800	ABWF work	0%	34	30	25-Sep-19 A	31-Dec-19	248				
Lift at TWSR-W Side											
L1800	THFB Completion Date	0%	0	0		31-Dec-19	248				31-Dec-19 ◆ THFB Completion Date
Lift at FLHY S/B											
L1400	Roof cover for RC Platform	0%	33	30	25-Sep-19 A	30-Dec-19	249				
L1430	EMSD inspection & approval	60.71%	11	28	21-Oct-19A	30-Nov-19	292				
L1440	E&M and Finishes work	0%	35	35	02-Dec-19	14-Jan-20	237				
L1460	Lift available - NF78	0%	0	0		14-Jan-20	237				14-Jan-20 ◆ Lift available - NF78
L1490	THFB Completion Date	0%	0	0		31-Dec-19	248				31-Dec-19 ◆ THFB Completion Date
New Tai Wo Footbridge											
General											
TWFB1110	Tai Wo Footbridge Complete	0%	0	0		30-Dec-19	235				30-Dec-19 ◆ Tai Wo Footbridge Complete
Crossing Fanling Highway Section											
TWFB1460	Finishes Work	80.36%	33	168	06-Apr-19A	30-Dec-19	235				
TWFB1470	Bridge Structure complete (TWFB-Cross fanling highway)	0%	0	0		30-Dec-19	235				30-Dec-19 ◆ Bridge Structure complete (TWFB
Lift at TWSR-W Side											
L1760	EMSD inspection & approval	71.43%	8	28	31-Oct-19A	27-Nov-19	322				
L1770	E&M and Finishes work	93.33%	10	150	23-Apr-19A	30-Nov-19	258				
L1790	Lift available - NF116-Lift 1	0%	0	0		30-Nov-19	258				30-Nov-19 ◆ Lift available - NF116-Lift 1
L1810	New Tai Wo footbridge completion	0%	0	0		30-Dec-19	249				30-Dec-19 ◆ New Tai Wo footbridge completor
Signalized Junction											
New Tai Hang Footbridge											
TWSR-West/ FL Highway N/B Side Section											
THBF0630	Installation of Traffic Signal Poles at TWSR-W N/B (Tai hang Junction)	0%	21	21	18-Jan-20	13-Feb-20	192				
THBF0650	Ducting & Cable Draw Installation (Tai hang Junction)	79.39%	27	131	08-May-19 A	20-Dec-19	192				
THBF0660	Installation of Traffic Signal Poles at TWSR-W S/B (Tai hang Junction)	0%	21	21	21-Dec-19	17-Jan-20	192				
THBF0670	E-prom ordering by EMSD (Tai hang Junction)	82.93%	56	328	20-Nov-18 A	14-Jan-20	302				
THBF0680	Ducting & cable draw inspection by EMSD (Tai hang Junction)	0%	6	6	15-Jan-20	21-Jan-20	213				
THBF0690	Ducting & cable draw rectification (Tai hang Junction)	0%	12	12	22-Jan-20	06-Feb-20	213				
THBF0692	PCCW cable installation & connection (Tai hang Junction)	0%	6	6	14-Feb-20	20-Feb-20	207				
THBF0694	EMSD cable & equipment installation (Tai hang Junction)	0%	21	21	14-Feb-20	09-Mar-20	192				
TWSR-West Construction											
Drainage & Road Works											
Ch 5880-6740											

<p> █ Remaining Level o... █ Actual Level of Effort █ Actual Work █ Remaining Work █ Critical Remaining ... ◆ Milestone ◆ Crit. Milestone </p>	Project ID: WP Rev 08 (1911) Layout: 3 Month Rolling Program Page 1 of 3	Contract No. HY/2012/06 Widening of Fanling Highway - Tai Hang to Wo Hop Shek Interchange 3 Month Rolling Program(20-Nov-19)		Date	Revision	C/A...
				17-Aug-17	WP Rev 5	
28-Mar-18	WP Rev 6					
27-Nov-18	WP Rev 6A					
15-Jan-19	WP Rev 7					
31-Oct-19	WP Rev 8					

WP Rev. 8 (Progress Update)(20-Nov-19)		3 Month Rolling Program						Page 2 of 3 (22-Nov-19)			
Activity ID	Activity Name	Dur. % Complete	Rem. Duration	Original Duration	Start	Finish	Total Float	2019		2020	
								Nov	Dec	Jan	Feb
RDZ20140	Z2 (CH5880-6930) : New TWSR - West Road works (2 lanes) complete	0%	0	0		03-Feb-20	222			03-Feb-20	◆ Z2 (CH5880-6930) : New TWSR - West Road works (2 lanes) complete
RDZ20170	Z2 : New TWSR-Westroad Works (lane 2)	0%	30	30	27-Dec-19	03-Feb-20	222				
Other Works											
TCSS Works											
Civil Provision for TCSS Works											
TCSS2140	M10 for CCTV	0%	14	14	31-Dec-19	16-Jan-20	235				
TCSS2180	Pillar box, isolator & associated duct work - PL204 for G30 & G55	0%	16	16	20-Nov-19	07-Dec-19	266				
TCSS2190	Pillar box, isolator & associated duct work - PL205 for G54 & M10	0%	16	16	20-Nov-19	07-Dec-19	266				
TCSS2200	Pillar box, isolator & associated duct work - PL206 for G32	0%	16	16	20-Nov-19	07-Dec-19	266				
TCSS2270	Civil Provision for TCSS works available (Zone 2)	0%	0	0		07-Dec-19	266				◆ Civil Provision for TCSS works available (Zone 2)
VO184 - Irrigation System in SA328 and SA329											
VO184 - Irrigation System in SA328 and SA329											
IS0140	Irrigation system installation in SA328 and SA329	34.69%	32	49	04-Sep-19 A	28-Dec-19	250				
VO189 - Irrigation System in Zone 1 and Zone 2											
VO189 - Irrigation System in Zone 1 and Zone 2											
IS0130	Irrigation system installation in Zone 2	4.08%	47	49	04-Sep-19 A	16-Jan-20	235				
Landscape Softwork											
Landscape Works											
Z2.LW.1000	Landscape soft work Zone2	0%	47	32	25-Sep-19 A	16-Jan-20	235				
Establishment Works											
Establishment Works											
Z2.EW.1000	Establishment work Zone2	4.66%	348	365	02-Nov-19 A	01-Nov-20	0				
Pai Lau in Tai Hang (VO126)											
Pai Lau in Tai Hang (VO126)											
Pai Lau in Tai Hang (VO126)											
PL01050	Pai Lau Superstructure	84.62%	10	65	07-Oct-19 A	30-Nov-19	231				
PL01080	Material Order & delivery on site	0%	45	45	20-Nov-19	14-Jan-20	196				
PL01090	Finishes works	0%	41	41	15-Jan-20	04-Mar-20	196				
South Buffer Zone 1 (SBZ1) (within Zone 2)(Ch.6740 to 6930)											
Bridge Construction											
Kau Lung Hang Vehicular Bridge											
KLH Bridge - West Ramp											
KLH.1290	West Ramp - Planting	0%	34	34	20-Nov-19*	31-Dec-19	248				
KLH Bridge - Deck 1											
KLH.3430	Deck 1 - Planting	0%	34	34	20-Nov-19	31-Dec-19	248				
KLH Bridge - Deck 3											
KLH.3500	Deck 3 - Planting	0%	34	34	20-Nov-19	31-Dec-19	248				
KLH Bridge - East Ramp											
KLH.3590	East Ramp - Planting	0%	34	34	20-Nov-19	31-Dec-19	248				
KLH Bridge - Staircase S1											
Z2.KLH.1500	S1 - Roof steel frame installation	75.61%	10	41	11-Sep-19 A	30-Nov-19	242				
Z2.KLH.1750	S1 - Corrugated steel roof	0%	18	18	02-Dec-19	21-Dec-19	242				
Z2.KLH.1760	S1 - Handrail	0%	12	12	23-Dec-19	08-Jan-20	242				
Z2.KLH.1770	S1 - Lighting & finishes works	0%	12	12	23-Dec-19	08-Jan-20	242				
Bridge Road Work											
Z2.KLH.2040	Landscape work of KLHVB	71.95%	46	164	23-Apr-19 A	15-Jan-20	236				
Signalized Junction											
Kau Lung Hang Vehicular Bridge											
KLH Bridge - West Ramp											
Z2.KLH.1032	Installation of Traffic Signal Poles at TWSR-W N/B (KLHVB)	0%	34	21	14-Nov-19 A	31-Dec-19	227				
Z2.KLH.1082	Ducting & cable draw rectification (KLHVB)	0%	22	12	19-Oct-19 A	14-Dec-19	248				
Z2.KLH.1092	PCCW cable installation & connection (KLHVB)	0%	6	6	02-Jan-20	08-Jan-20	236				
Z2.KLH.1102	EMSD cable & equipment installation (KLHVB)	0%	21	21	02-Jan-20	28-Jan-20	227				
Z2.KLH.1112	Traffic Signal Installation complete (KLHVB)	0%	0	0		28-Jan-20	227				◆ Traffic Signal
North Buffer Zone 2 (NBZ2) (within Zone 4) (Ch. 7925 to 8100)											
Bridge Construction											
New Ho Ka Yuen Footbridge											
TWSR-West/ FL Highway N/B Side Section											
HKY1520	VO11 - slope improvement work	0%	45	45	20-Nov-19	14-Jan-20	237				
ZONE 4 (Ch. 7925 to 8700)											
Bridge Construction											
New Wo Hop Shek Pedestrian & Cycle Bridge											
General											
WHS1110	Wo Hop Shek Bridge Complete	0%	0	0		31-Dec-19	248				◆ Wo Hop Shek Bridge Complete
TWSR-West/ FL Highway N/B Side Section											
WHS1420	Ramp Finishes Work	91.37%	34	394	13-Jul-18 A	31-Dec-19	248				
WHS1430	Bridge Structure complete (WHS-TWSR-W side)	0%	0	0		31-Dec-19	248				◆ Bridge Structure complete (WHS-TWSR-W side)

**APPENDIX C
IMPLEMENTATION SCHEDULE OF
ENVIRONMENTAL MITIGATION MEASURES
(EMIS)**

Appendix C - Implementation Schedule of Environmental Mitigation Measures (EMIS)

Air Quality – Schedule of Recommended Mitigation Measures

Impact	Mitigation Measures	Timing	Implementation Status
Air Quality during construction	Restricting heights from which materials are dropped, as far as practicable to minimize the fugitive dust arising from unloading/loading.	During construction	V
	All stockpiles of excavated materials or spoil of more than 50m ³ shall be enclosed, covered or dampened during dry or windy conditions.		V
	Effective water sprays shall be used to control potential dust emission sources such as unpaved haul roads and active construction areas.		V
	All spraying of materials and surfaces shall avoid excessive water usage.		V
	Vehicles that have the potential to create dust while transporting materials shall be covered, with the cover properly secured and extended over the edges of the side and tail boards.		V
	Materials shall be dampened, if necessary, before transportation.		V
	Travelling speeds shall be controlled to reduce traffic induced dust dispersion and re-suspension within the site from the operating haul trucks.		V
	Vehicle washing facilities shall be provided to minimize the quantity of material deposited on public roads.		V

Noise – Schedule of Recommended Mitigation Measures

Impact	Mitigation Measures	Timing	Implementation Status
Noise during construction	Use of silenced plant or plant equipped with mufflers or dampers in substitute of ordinary plant.	During construction	V
	Reduce the number of equipment and their percentage on-time.		V
	3.5 m and 5.5 m high temporary noise barrier at culvert construction work area (Figure 2a of the Environmental Permit).		V*
	3 m high temporary noise barrier along the northern edge of Bridge 12 at ground level (Figure 2b of the Environmental Permit).		V*
	2 m high temporary noise barrier along the northern edge of Bridge 12 at bridge level (Figure 2b of the Environmental Permit).		V*
	2.5 m high temporary noise barrier along Tai Wo Service Road West (Figure 2c of the Environmental Permit).		V*
	3.5m and 7m high temporary noise barrier along Tai Wo Services Road West near Tai Hang (Figure 2c of the Environmental Permit).		V*
	7 m high temporary noise barrier along Tai Wo Service Road West near Tai Wo Footbridge work area (Figure 2d of the Environmental Permit).		V*
	7 m high temporary noise barrier near Kiu Tau Footbridge work area (Figure 2d of the Environmental Permit).		V*
	2.5 m high temporary noise barrier near river diversion work area (Figure 2e of the Environmental Permit).		V*
Noise during operation	Various type of barriers of varying heights as shown in Figures 4a to 4e – Layout of Noise Barriers of the Environmental Permit	Review of required noise barrier layout during the design stage	V*

* Permanent noise barriers have been erected.

Water Quality – Schedule of Recommended Mitigation Measures

Impact	Mitigation Measures	Timing	Implementation Status
Water quality during construction	Demolition and reconstruction of bridges <ul style="list-style-type: none"> - Prevent off-site migration through use of sheet piles. - Minimise duration of works as far as practical. - All sewer and drainage connections should be sealed to prevent debris, soil, sand, etc, from entering public sewers/drains. - Site surface runoff should be settled to remove sand/silt before it is discharged into the existing storm drains. 	During construction	V
	Road Widening Works, Earthworks and Culvert Extension Works <ul style="list-style-type: none"> - Wastewater generated from any concrete batching washdown of equipment or similar activities should be discharged into foul sewers, after the removal of settleable solids, and pH adjustment as necessary. All sewage discharges from the study area should meet the TM standards and approval from EPD through the licensing process is required. - Sand traps, oil interceptors and other pollution prevention installations should be provided, properly cleaned and maintained. - Runoff from exposed working areas, unfinished slopes and from unlined temporary channels should be directed to stilling basins and/or silt traps before discharging to the drainage outfalls. - Regular inspections of stilling basins and/or silt traps are required to ensure that sediment is not conveyed into the existing drainage system. - Open stockpiles should be covered with a tarpaulin cover. - During the wet season, any exposed top soils should be covered with a tarpaulin, shotcreted or hydroseeded. - Sand and silt from wash-water from vehicle washing should be settled out before discharging into storm drains. - Fuels should be stored in bunded areas such that spillage can be easily collected. 		V

Waste – Schedule of Recommended Mitigation Measures

Impact	Mitigation Measures	Timing	Implementation Status
Waste management during construction	General Waste <ul style="list-style-type: none"> - Transport of wastes off site as soon as possible. - Maintenance of accurate waste records. - Minimisation of waste generation for disposal (via reduction/recycling/re-use). - No on-site burning will be permitted. - Use of re-useable metal hoardings/signboards. 	During construction	V
	Vegetation from site clearance <ul style="list-style-type: none"> - Segregation of materials to facilitate disposal. - Mulching to reduce bulk and where possible review opportunities for the possible beneficial use within landscaping areas. 		V
	Demolition Wastes <ul style="list-style-type: none"> - Segregation of materials to facilitate disposal. - Appropriate stockpile management. 		V
	Excavated Materials <ul style="list-style-type: none"> - Segregation of materials to facilitate disposal / reuse. - Appropriate stockpile management. - Re-use of excavated material on or off site (where possible). - Special handling and disposal procedures in the event that contaminated materials are excavated. 		V
	Construction Wastes <ul style="list-style-type: none"> - Segregation of materials to facilitate recycling/reuse (within designated area in appropriate containers/stockpiles). - Appropriate stockpile management. - Planning to reduce over ordering and waste generation. - Recycling and re-use of materials where possible (e.g. metal, wood from formwork) - For material which cannot be re-used/recycled, collection should be carried out by an approved waste contractor for landfill disposal. 		V
	Bentonite Slurries <ul style="list-style-type: none"> - Bentonite slurries should be reused as far as possible. - Disposal in accordance with Practice Note For Professional Persons ProPECC PN 1/94. 		#

	<p>Chemical Wastes</p> <ul style="list-style-type: none"> - Storage within locked, covered and bunded area. - The storage area shall not be located adjacent to sensitive receivers e.g. drains. - Minimise waste production and recycle oils/solvents where possible. - A spill response procedure shall be in place and absorption material available for minor spillages. - Use appropriate and labelled containers. - Educate site workers on site cleanliness/waste management procedures. - If chemical wastes are to be generated, the contractor must register with EPD as a chemical waste producer. - The chemical wastes shall be collected by a licensed chemical waste collector. 		<p>@</p>
	<p>Municipal Wastes</p> <ul style="list-style-type: none"> - Waste shall be stored within a temporary refuse collection facility, in appropriate containers prior to collection and disposal. - Regular, daily collections are required by an approved waste collector. 		<p>V</p>

Ecology – Schedule of Recommended Mitigation Measures

Impact	Mitigation Measures	Timing	Implementation Status
Ecology during construction	<p>Accurate Delineation of Works Area</p> <ul style="list-style-type: none"> - Boundaries of proposed works areas shall be clearly identified and separated from external areas by a physical barrier to prevent encroachment of adjacent habitats. - Individual trees which fall within the works areas but which work plans do not require removal are to be retained and fenced off to maximize protection. 	During construction	V
	<p>Vegetation Clearance</p> <ul style="list-style-type: none"> - No fires shall be lit within the works area for the purpose of burning cleared vegetation. - The Contractor shall give consideration to mulching the cleared vegetation for recycling within the works area / adjacent land. 		V
	<p>Dust generation</p> <p>There are a number of measures which shall be taken as specified in the Air Pollution Control (Construction Dust) Regulation on 'Dust Control Requirements, including the following key measures to be applied during construction:</p> <ul style="list-style-type: none"> - Vehicle washing facilities to be provided at every discernible or designated vehicle exit point; - All temporary site access roads shall be sprayed with water to suppress dust as necessary; - All dusty materials should be sprayed with water immediately prior to any handling; and - All debris should be covered entirely by impervious sheeting or stored in a sheltered debris collection area. 		V
	<p>Surface Run-off</p> <p>In general, mitigation measures shall be in accordance with ProPECC PN1/94 on 'Construction Site Drainage'. Key measures include:</p> <ul style="list-style-type: none"> - Bund and cover stock piles to avoid run-off; - Channel any run-off through a system of oil, grease and sediment / silt traps and reuse water on site where ever practical; - All vehicle maintenance to be undertaken within a bunded area; and - Maximise vegetation retention on-site to maximise absorption (minimise transport). 		V

Landscape and Visual Impact – Schedule of Recommended Mitigation Measures

Impact	Mitigation Measures	Timing	Responsibility
Landscape & Visual during construction	Preservation of Existing Vegetation - Trees identified for retention within the project limit would be protected during the works; - The tree transplanting and planting works shall be implemented by approved Landscape Contractors.	During construction	V
	Temporary Works Areas - Where feasible the works areas would be screened using hoarding and existing vegetation would be retained where possible to reduce the landscape and visual impacts arising from the construction activity. The landscape of these works areas would be restored following the completion of the construction phase.		V
	Hoarding - A hoarding would be erected where practicable in the most visually sensitive locations to screen the temporary construction works from the local VSRs.		V
	Top Soils - The works will result in disturbance to extensive areas of topsoil. Topsoil worthy of retention should be stockpiled for use following completion of the civil engineering works. It should either be temporarily vegetated with hydroseeded grass or turned over on a regular basis.		#
	Protection of Important Landscape Features - Important features such as temples, Island House and kilns within the study area, although remote from the proposed works retained and adequately protected.		V

Legend:

V = implemented;

x = not implemented;

@ = partially implemented;

+ = recommended and immediately implemented during the site inspection by the Contractor;

N/A = not applicable - No such work was undertaken or no such material was used on site;

= to be implemented.

**APPENDIX D
SUMMARY OF ACTION AND LIMIT LEVELS**

Appendix D - Summary of Action and Limit Levels

Table 1 – Action and Limit Levels for 1-hour TSP

Location	Action Level	Limit Level
AM2	317.8 µg/m ³	500 µg/m ³

Table 2 – Action and Limit Levels for 24-hour TSP

Location	Action Level	Limit Level
AM2	200.7 µg/m ³	260 µg/m ³

Table 3 – Action and Limit Levels for Construction Noise (0700-1900 hrs of normal weekdays)

Location	Action Level	Limit Level
M2	When one documented complaint, related to 0700 – 1900 hours on normal weekdays, is received from any one of the sensitive receivers	75 dB(A)
M3*		65/70 dB(A)

*Daytime noise Limit Level of 70 dB(A) applies to education institutions, while 65dB(A) applies during school examination period

**APPENDIX E
CALIBRATION CERTIFICATES OF
MONITORING EQUIPMENTS**

Certificate of Calibration

Calibration Certification Information			
Cal. Date: June 5, 2020	Rootsmeter S/N: 438320	Ta: 295 °K	
Operator: Jim Tisch		Pa: 748.0 mm Hg	
Calibration Model #: TE-5025A	Calibrator S/N: 0988		

Run	Vol. Init (m3)	Vol. Final (m3)	ΔVol. (m3)	ΔTime (min)	ΔP (mm Hg)	ΔH (in H2O)
1	1	2	1	1.3610	3.2	2.00
2	3	4	1	0.9700	6.4	4.00
3	5	6	1	0.8630	7.9	5.00
4	7	8	1	0.8240	8.8	5.50
5	9	10	1	0.6800	12.9	8.00

Data Tabulation					
Vstd (m3)	Qstd (x-axis)	$\sqrt{\Delta H \left(\frac{Pa}{Pstd} \right) \left(\frac{Tstd}{Ta} \right)}$ (y-axis)	Va	Qa (x-axis)	$\sqrt{\Delta H \left(\frac{Ta}{Pa} \right)}$ (y-axis)
0.9900	0.7274	1.4101	0.9957	0.7316	0.8881
0.9858	1.0162	1.9943	0.9914	1.0221	1.2560
0.9838	1.1399	2.2296	0.9894	1.1465	1.4042
0.9826	1.1924	2.3385	0.9882	1.1993	1.4728
0.9771	1.4369	2.8203	0.9828	1.4452	1.7762
QSTD	m=	1.98556	QA	m=	1.24332
	b=	-0.03069		b=	-0.01933
	r=	0.99996		r=	0.99996

Calculations	
Vstd= $\Delta Vol \left(\frac{Pa - \Delta P}{Pstd} \right) \left(\frac{Tstd}{Ta} \right)$	Va= $\Delta Vol \left(\frac{Pa - \Delta P}{Pa} \right)$
Qstd= $Vstd / \Delta Time$	Qa= $Va / \Delta Time$
For subsequent flow rate calculations:	
Qstd= $1/m \left(\left(\sqrt{\Delta H \left(\frac{Pa}{Pstd} \right) \left(\frac{Tstd}{Ta} \right)} \right) - b \right)$	Qa= $1/m \left(\left(\sqrt{\Delta H \left(\frac{Ta}{Pa} \right)} \right) - b \right)$

Standard Conditions	
Tstd:	298.15 °K
Pstd:	760 mm Hg
Key	
ΔH: calibrator manometer reading (in H2O)	
ΔP: rootsmeter manometer reading (mm Hg)	
Ta: actual absolute temperature (°K)	
Pa: actual barometric pressure (mm Hg)	
b: intercept	
m: slope	

RECALIBRATION
US EPA recommends annual recalibration per 1998 40 Code of Federal Regulations Part 50 to 51, Appendix B to Part 50, Reference Method for the Determination of Suspended Particulate Matter in the Atmosphere, 9.2.17, page 30

Total Suspended Particulates (TSP) Sampler
Field Calibration Report

Station <u>Fanling Government Secondary School (AM2)</u>	Operator: <u>Choi Wing Ho</u>
Date: <u>26-Feb-21</u>	Next Due Date: <u>26-Apr-21</u>
Model No: <u>TE-5170</u>	Verified Against: <u>O.T.S -- 988</u>
Equipment No.: <u>A-001-74T</u>	Expiration Date: <u>5-Jun-21</u>

Ambient Condition			
Temperature, Ta	295.0	Kelvin	Pressure, Pa
			755.5 mmHg

Orifice Transfer Standard Information					
Equipment No.:	988	Slope, mc	1.98556	Intercept, bc	-0.03069
Last Calibration Date:	5 Jun 2020	$mc \times Qstd + bc = [H \times (Pa/760) \times (298/Ta)]^{1/2}$			
Next Calibration Date:	5 Jun 2021				

Calibration of TSP Sampler					
Calibration Point	H in. of water	$[H \times (Pa/760) \times (298/Ta)]^{1/2}$	Qstd (m ³ /min) X - axis	W in. of oil	$[\Delta W \times (Pa/760) \times (298/Ta)]^{1/2}$ Y-axis
1	7.0	2.65	1.35	5.4	2.33
2	5.6	2.37	1.21	4.2	2.05
3	4.5	2.13	1.09	3.2	1.79
4	3.4	1.85	0.95	2.4	1.55
5	2.5	1.58	0.81	1.6	1.27

By Linear Regression of Y on X
 Slope , mw = 1.9541 Intercept, bw = -0.3164
 Correlation Coefficient* = 0.9995

Set Point Calculation

From the TSP Field Calibration Curve, take Qstd = 1.21 m³/min (43 CFM)
 From the Regression Equation, the "Y" value according to

$$m \times Qstd + b = [W \times (Pa/760) \times (298/Ta)]^{1/2}$$

Therefore, Set Point W = $(m \times Qstd + b)^2 \times (760 / Pa) \times (Ta / 298) =$ 4.18

*If Correlation Coefficient < 0.990, check and recalibrate again.

Remarks: _____

QC Reviewer: WS CHAN Signature: [Signature] Date: 26/02/21

EQUIPMENT CALIBRATION RECORD

Type: Laser Dust Monitor
 Manufacturer/Brand: SIBATA
 Model No.: LD-3
 Equipment No.: A.005.07a
 Sensitivity Adjustment Scale Setting: 557 CPM

Operator: Mike Shek (MSKM)

Standard Equipment

Equipment: Rupprecht & Patashnick TEOM®
 Venue: Cyberport (Pui Ying Secondary School)
 Model No.: Series 1400AB
 Serial No: Control: 140AB219899803
 Sensor: 1200C143659803 Ko: 12500
 Last Calibration Date*: 1 May 2020

*Remarks: Recommended interval for hardware calibration is 1 year

Calibration Result

Sensitivity Adjustment Scale Setting (Before Calibration): 557 CPM
 Sensitivity Adjustment Scale Setting (After Calibration): 557 CPM

Hour	Date (dd-mm-yy)	Time	Ambient Condition		Concentration ¹ (mg/m ³) Y-axis	Total Count ²	Count/ Minute ³ X-axis
			Temp (°C)	R.H. (%)			
1	02-05-20	09:15 - 10:15	26.7	77	0.04836	1945	32.42
2	02-05-20	10:15 - 11:15	26.7	77	0.05134	2056	34.27
3	02-05-20	11:15 - 12:15	26.8	77	0.05331	2130	35.50
4	02-05-20	12:15 - 13:15	26.8	77	0.05535	2214	36.90

Note: 1. Monitoring data was measured by Rupprecht & Patashnick TEOM®
 2. Total Count was logged by Laser Dust Monitor
 3. Count/minute was calculated by (Total Count/60)

By Linear Regression of Y or X

Slope (K-factor): 0.0015
 Correlation coefficient: 0.9976

Validity of Calibration Record: 2 May 2021

Remarks:

QC Reviewer: YW Fung

Signature: 

Date: 04 May 2020

EQUIPMENT CALIBRATION RECORD

Type: Laser Dust Monitor
 Manufacturer/Brand: SIBATA
 Model No.: LD-3
 Equipment No.: A.005.09a
 Sensitivity Adjustment Scale Setting: 797 CPM

Operator: Mike Shek (MSKM)

Standard Equipment

Equipment: Rupprecht & Patashnick TEOM®
 Venue: Cyberport (Pui Ying Secondary School)
 Model No.: Series 1400AB
 Serial No: Control: 140AB219899803
 Sensor: 1200C143659803 Ko: 12500
 Last Calibration Date*: 1 May 2020

*Remarks: Recommended interval for hardware calibration is 1 year

Calibration Result

Sensitivity Adjustment Scale Setting (Before Calibration): 797 CPM
 Sensitivity Adjustment Scale Setting (After Calibration): 797 CPM

Hour	Date (dd-mm-yy)	Time	Ambient Condition		Concentration ¹ (mg/m ³) Y-axis	Total Count ²	Count/ Minute ³ X-axis
			Temp (°C)	R.H. (%)			
1	02-05-20	09:45 - 10:45	26.7	77	0.04884	1956	32.60
2	02-05-20	10:45 - 11:45	26.7	77	0.05157	2070	34.50
3	02-05-20	11:45 - 12:45	26.8	77	0.05355	2158	35.97
4	02-05-20	12:45 - 13:45	26.8	77	0.05593	2241	37.35

- Note:
1. Monitoring data was measured by Rupprecht & Patashnick TEOM®
 2. Total Count was logged by Laser Dust Monitor
 3. Count/minute was calculated by (Total Count/60)

By Linear Regression of Y or X

Slope (K-factor): 0.0015
 Correlation coefficient: 0.9974

Validity of Calibration Record: 2 May 2021

Remarks:

QC Reviewer: YW Fung

Signature: 

Date: 04 May 2020

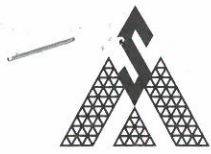

CERTIFICATE OF CALIBRATION

Certificate No.: 20CA0914 02 Page 1 of 2

Item tested

Description:	Sound Level Meter (Type 1)	,	Microphone
Manufacturer:	B & K	,	B & K
Type/Model No.:	2238	,	4188
Serial/Equipment No.:	2800927	,	2250455
Adaptors used:	-	,	-

Item submitted by

Customer Name: AECOM ASIA CO., LTD.
Address of Customer: -
Request No.: -
Date of receipt: 14-Sep-2020

Date of test: 19-Sep-2020

Reference equipment used in the calibration

Description:	Model:	Serial No.	Expiry Date:	Traceable to:
Multi function sound calibrator	B&K 4226	2288444	23-Aug-2021	CIGISMEC
Signal generator	DS 360	61227	24-Dec-2020	CEPREI

Ambient conditions

Temperature: 22 ± 1 °C
Relative humidity: 55 ± 10 %
Air pressure: 1000 ± 5 hPa

Test specifications

- 1, The Sound Level Meter has been calibrated in accordance with the requirements as specified in BS 7580: Part 1: 1997 and the lab calibration procedure SMTP004-CA-152.
- 2, The electrical tests were performed using an electrical signal substituted for the microphone which was removed and replaced by an equivalent capacitance within a tolerance of ±20%.
- 3, The acoustic calibration was performed using an B&K 4226 sound calibrator and corrections was applied for the difference between the free-field and pressure responsiveness of the Sound Level Meter.

Test results

This is to certify that the Sound Level Meter conforms to BS 7580: Part 1: 1997 for the conditions under which the test was performed.

Details of the performed measurements are presented on page 2 of this certificate.

Actual Measurement data are documented on worksheets.

Approved Signatory:

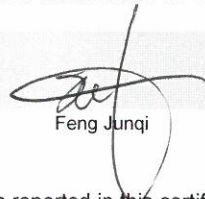

Feng Junqi

Date: 20-Sep-2020

Company Chop:

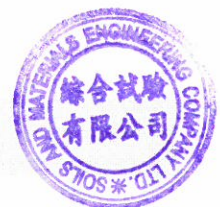

Comments: The results reported in this certificate refer to the condition of the instrument on the date of calibration and carry no implication regarding the long-term stability of the instrument. The results apply to the item as received.



CERTIFICATE OF CALIBRATION

(Continuation Page)

Certificate No.: 20CA0914 02

Page 2 of 2

1, Electrical Tests

The electrical tests were performed using an equivalent capacitance substituted for the microphone. The results are given in below with test status and the estimated uncertainties. The "Pass" means the result of the test is inside the tolerances stated in the test specifications. The "-" means the result of test is outside these tolerances.

Test:	Subtest:	Status:	Expanded Uncertainty (dB)	Coverage Factor
Self-generated noise	A	Pass	0.3	
	C	Pass	1.0	2.1
	Lin	Pass	2.0	2.2
Linearity range for Leq	At reference range , Step 5 dB at 4 kHz	Pass	0.3	
	Reference SPL on all other ranges	Pass	0.3	
	2 dB below upper limit of each range	Pass	0.3	
	2 dB above lower limit of each range	Pass	0.3	
Linearity range for SPL	At reference range , Step 5 dB at 4 kHz	Pass	0.3	
	Frequency weightings	A	0.3	
Time weightings	C	Pass	0.3	
	Lin	Pass	0.3	
	Single Burst Fast	Pass	0.3	
Peak response	Single Burst Slow	Pass	0.3	
	Single 100µs rectangular pulse	Pass	0.3	
R.M.S. accuracy	Crest factor of 3	Pass	0.3	
Time weighting I	Single burst 5 ms at 2000 Hz	Pass	0.3	
	Repeated at frequency of 100 Hz	Pass	0.3	
Time averaging	1 ms burst duty factor 1/10 ³ at 4kHz	Pass	0.3	
	1 ms burst duty factor 1/10 ⁴ at 4kHz	Pass	0.3	
Pulse range	Single burst 10 ms at 4 kHz	Pass	0.4	
	Single burst 10 ms at 4 kHz	Pass	0.4	
Sound exposure level	SPL	Pass	0.3	
	Leq	Pass	0.4	

2, Acoustic tests

The complete sound level meter was calibrated on the reference range using a B&K 4226 acoustic calibrator with 1000Hz and SPL 94 dB. The sensitivity of the sound level meter was adjusted. The test result at 125 Hz and 8000 Hz are given in below with test status and the estimated uncertainties.

Test:	Subtest	Status	Expanded Uncertainty (dB)	Coverage Factor
Acoustic response	Weighting A at 125 Hz	Pass	0.3	
	Weighting A at 8000 Hz	Pass	0.5	

3, Response to associated sound calibrator

N/A

The expanded uncertainties have been calculated in accordance with the ISO Publication "Guide to the expression of uncertainty in measurement", and gives an interval estimated to have a level of confidence of 95%. A coverage factor of 2 is assumed unless explicitly stated.

- End -

Calibrated by:

Fung Chi Yip

Date: 19-Sep-2020

Checked by:

Feng Junqi

Date: 20-Sep-2020

The standard(s) and equipment used in the calibration are traceable to national or international recognised standards and are calibrated on a schedule to maintain the required accuracy level.



CERTIFICATE OF CALIBRATION

Certificate No.: 20CA0925 02 Page 1 of 2

Item tested

Description:	Sound Level Meter (Type 1)	, Microphone	Pream
Manufacturer:	B & K	, B & K	B & K
Type/Model No.:	2270	, 4189	ZC0032
Serial/Equipment No.:	3007965 / N.012.02	, 2846461	17965
Adaptors used:	-	, -	-

Item submitted by

Customer Name: AECOM ASIA CO. LTD.
Address of Customer: -
Request No.: -
Date of receipt: 25-Sep-2020

Date of test: 29-Sep-2020

Reference equipment used in the calibration

Description:	Model:	Serial No.	Expiry Date:	Traceable to:
Multi function sound calibrator	B&K 4226	2288444	23-Aug-2021	CIGISMEC
Signal generator	DS 360	61227	24-Dec-2020	CEPREI

Ambient conditions

Temperature: 22 ± 1 °C
Relative humidity: 55 ± 10 %
Air pressure: 1005 ± 5 hPa

Test specifications

- 1, The Sound Level Meter has been calibrated in accordance with the requirements as specified in BS 7580: Part 1: 1997 and the lab calibration procedure SMTP004-CA-152.
- 2, The electrical tests were performed using an electrical signal substituted for the microphone which was removed and replaced by an equivalent capacitance within a tolerance of $\pm 20\%$.
- 3, The acoustic calibration was performed using an B&K 4226 sound calibrator and corrections was applied for the difference between the free-field and pressure responsiveness of the Sound Level Meter.

Test results

This is to certify that the Sound Level Meter conforms to BS 7580: Part 1: 1997 for the conditions under which the test was performed.

Details of the performed measurements are presented on page 2 of this certificate.

Actual Measurement data are documented on worksheets.

Approved Signatory:

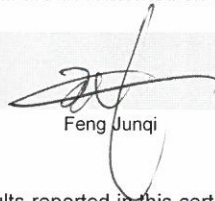

Feng Junqi

Date: 30-Sep-2020

Company Chop:

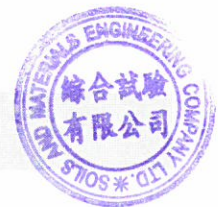

Comments: The results reported in this certificate refer to the condition of the instrument on the date of calibration and carry no implication regarding the long-term stability of the instrument.



CERTIFICATE OF CALIBRATION

(Continuation Page)

Certificate No.: 20CA0925 02

Page 2 of 2

1, Electrical Tests

The electrical tests were performed using an equivalent capacitance substituted for the microphone. The results are given in below with test status and the estimated uncertainties. The "Pass" means the result of the test is inside the tolerances stated in the test specifications. The "-" means the result of test is outside these tolerances.

Test:	Subtest:	Status:	Uncertainty (dB) / Coverage Factor	
Self-generated noise	A	Pass	0.3	
	C	Pass	1.0	2.1
	Lin	Pass	2.0	2.2
Linearity range for Leq	At reference range , Step 5 dB at 4 kHz	Pass	0.3	
	Reference SPL on all other ranges	Pass	0.3	
	2 dB below upper limit of each range	Pass	0.3	
	2 dB above lower limit of each range	Pass	0.3	
		Pass	0.3	
Linearity range for SPL	At reference range , Step 5 dB at 4 kHz	Pass	0.3	
		Pass	0.3	
Frequency weightings	A	Pass	0.3	
	C	Pass	0.3	
	Lin	Pass	0.3	
		Pass	0.3	
Time weightings	Single Burst Fast	Pass	0.3	
	Single Burst Slow	Pass	0.3	
Peak response	Single 100µs rectangular pulse	Pass	0.3	
R.M.S. accuracy	Crest factor of 3	Pass	0.3	
Time weighting I	Single burst 5 ms at 2000 Hz	Pass	0.3	
	Repeated at frequency of 100 Hz	Pass	0.3	
Time averaging	1 ms burst duty factor 1/10 ³ at 4kHz	Pass	0.3	
	1 ms burst duty factor 1/10 ⁴ at 4kHz	Pass	0.3	
Pulse range	Single burst 10 ms at 4 kHz	Pass	0.4	
Sound exposure level	Single burst 10 ms at 4 kHz	Pass	0.4	
Overload indication	SPL	Pass	0.3	
	Leq	Pass	0.4	

2, Acoustic tests

The complete sound level meter was calibrated on the reference range using a B&K 4226 acoustic calibrator with 1000Hz and SPL 94 dB. The sensitivity of the sound level meter was adjusted. The test result at 125 Hz and 8000 Hz are given in below with test status and the estimated uncertainties.

Test:	Subtest	Status	Uncertainty (dB) / Coverage Factor	
Acoustic response	Weighting A at 125 Hz	Pass	0.3	
	Weighting A at 8000 Hz	Pass	0.5	

3, Response to associated sound calibrator

N/A

The uncertainties have been calculated in accordance with the ISO Publication "Guide to the expression of uncertainty in measurement", and gives an interval estimated to have a level of confidence of 95 %. A coverage factor of 2 is assumed unless explicitly stated.

- End -

Calibrated by:

Date: 29-Sep-2020

Fung Chi Yip

Checked by:

Date: 30-Sep-2020

Feng Junqi

The standard(s) and equipment used in the calibration are traceable to national or international recognised standards and are calibrated on a schedule to maintain the required accuracy level.



CERTIFICATE OF CALIBRATION

Certificate No.: 20CA1019 02-02

Page: 1 of 2

Item tested

Description: Acoustical Calibrator (Class 1)
Manufacturer: B & K
Type/Model No.: 4231
Serial/Equipment No.: 3014024 / N004.04
Adaptors used: -

Item submitted by

Customer: AECOM ASIA CO LIMITED
Address of Customer: -
Request No.: -
Date of receipt: 19-Oct-2020

Date of test: 22-Oct-2020

Reference equipment used in the calibration

Description:	Model:	Serial No.	Expiry Date:	Traceable to:
Lab standard microphone	B&K 4180	2341427	11-May-2021	SCL
Preamplifier	B&K 2673	2743150	03-Jun-2021	CEPREI
Measuring amplifier	B&K 2610	2346941	03-Jun-2021	CEPREI
Signal generator	DS 360	33873	19-May-2021	CEPREI
Digital multi-meter	34401A	US36087050	19-May-2021	CEPREI
Audio analyzer	8903B	GB41300350	18-May-2021	CEPREI
Universal counter	53132A	MY40003662	18-May-2021	CEPREI

Ambient conditions

Temperature: 22 ± 1 °C
Relative humidity: 55 ± 10 %
Air pressure: 1005 ± 5 hPa

Test specifications

- The Sound Calibrator has been calibrated in accordance with the requirements as specified in IEC 60942 1997 Annex B and the lab calibration procedure SMTP004-CA-156.
- The calibrator was tested with its axis vertical facing downwards at the specific frequency using insert voltage technique.
- The results are rounded to the nearest 0.01 dB and 0.1 Hz and have not been corrected for variations from a reference pressure of 1013.25 hectoPascals as the maker's information indicates that the instrument is insensitive to pressure changes.

Test results

This is to certify that the sound calibrator conforms to the requirements of annex B of IEC 60942: 1997 for the conditions under which the test was performed. This does not imply that the sound calibrator meets IEC 60942 under any other conditions.

Details of the performed measurements are presented on page 2 of this certificate.

Approved Signatory:

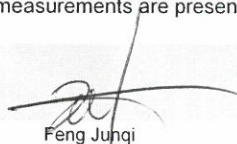
Feng Junqi

Date: 23-Oct-2020

Company Chop:



Comments: The results reported in this certificate refer to the condition of the instrument on the date of calibration and carry no implication regarding the long-term stability of the instrument. The results apply to the item as received.

**CERTIFICATE OF CALIBRATION**

(Continuation Page)

Certificate No.: 20CA1019 02-02

Page: 2 of 2

1, Measured Sound Pressure Level

The output Sound Pressure Level in the calibrator head was measured at the setting and frequency shown using a calibrated laboratory standard microphone and insert voltage technique. The results are given in below with the estimated uncertainties.

Frequency Shown Hz	Output Sound Pressure Level Setting dB	Measured Output Sound Pressure Level dB	(Output level in dB re 20 µPa)
			Estimated Expanded Uncertainty dB
1000	94.00	93.98	0.10

2, Sound Pressure Level Stability - Short Term Fluctuations

The Short Term Fluctuations was determined by measuring the maximum and minimum of the fast weighted DC output of the B&K 2610 measuring amplifier over a 20 second time interval as required in the standard. The Short Term Fluctuation was found to be:

At 1000 Hz STF = 0.014 dB
Estimated expanded uncertainty 0.005 dB

3, Actual Output Frequency

The determination of actual output frequency was made using a B&K 4180 microphone together with a B&K 2673 preamplifier connected to a B&K 2610 measuring amplifier. The AC output of the B&K 2610 was taken to an universal counter which was used to determine the frequency averaged over 20 second of operation as required by the standard. The actual output frequency at 1 KHz was:

At 1000 Hz Actual Frequency = 1000.0 Hz
Estimated expanded uncertainty 0.1 Hz Coverage factor k = 2.2

4, Total Noise and Distortion

For the Total Noise and Distortion measurement, the unfiltered AC output of the B&K 2610 measuring amplifier was connected to an Agilent Type 8903 B distortion analyser. The TND result at 1 KHz was:

At 1000 Hz TND = 0.5 %
Estimated expanded uncertainty 0.7 %

The expanded uncertainties have been calculated in accordance with the ISO Publication "Guide to the expression of uncertainty in measurement", and gives an interval estimated to have a level of confidence of 95%. A coverage factor of 2 is assumed unless explicitly stated.

- End -

Calibrated by:

Date:

Fung Chi Yip
22-Oct-2020

Checked by:

Date:

Feng Junqi
23-Oct-2020

The standard(s) and equipment used in the calibration are traceable to national or international recognised standards and are calibrated on a schedule to maintain the required accuracy level.

**APPENDIX F
EM&A MONITORING SCHEDULES**

Contract No. HY/2012/06
Widening of Fanling Highway – Tai Hang to Wo Hop Shek Interchange
Impact Monitoring and Audit Schedule for March 2021

Sunday	Monday	Tuesday	Wednesday	Thursday	Friday	Saturday
	1-Mar	2-Mar	3-Mar	4-Mar	5-Mar	6-Mar
		Site Audit			1-hr TSP 24-hr TSP Noise	
7-Mar	8-Mar	9-Mar	10-Mar	11-Mar	12-Mar	13-Mar
		Site Audit		1-hr TSP 24-hr TSP Noise		
14-Mar	15-Mar	16-Mar	17-Mar	18-Mar	19-Mar	20-Mar
		Site Audit	1-hr TSP 24-hr TSP Noise			
21-Mar	22-Mar	23-Mar	24-Mar	25-Mar	26-Mar	27-Mar
		1-hr TSP 24-hr TSP Noise Site Audit				1-hr TSP 24-hr TSP
28-Mar	29-Mar	30-Mar	31-Mar			
			Site Audit			

Contract No. HY/2012/06
Widening of Fanling Highway – Tai Hang to Wo Hop Shek Interchange
Tentative Impact Monitoring and Audit Schedule for April 2021

Sunday	Monday	Tuesday	Wednesday	Thursday	Friday	Saturday
				1-Apr	2-Apr	3-Apr
				1-hr TSP 24-hr TSP Noise		
4-Apr	5-Apr	6-Apr	7-Apr	8-Apr	9-Apr	10-Apr
			1-hr TSP 24-hr TSP Noise Site Audit			
11-Apr	12-Apr	13-Apr	14-Apr	15-Apr	16-Apr	17-Apr
		1-hr TSP 24-hr TSP Noise Site Audit				1-hr TSP 24-hr TSP
18-Apr	19-Apr	20-Apr	21-Apr	22-Apr	23-Apr	24-Apr
					1-hr TSP 24-hr TSP Noise	
25-Apr	26-Apr	27-Apr	28-Apr	29-Apr	30-Apr	
		Site Audit		1-hr TSP 24-hr TSP Noise		

The schedule is subject to change due to unforeseeable circumstances (e.g. adverse weather, etc)

**APPENDIX G
IMPACT AIR QUALITY MONITORING
RESULTS AND THEIR GRAPHICAL
PRESENTATION**

Appendix G
Impact Air Quality Monitoring Results

1-hour TSP Monitoring Results at Station AM2
(Fanling Government Secondary School)

Date	Start Time (hh:mm)	1st Hour Conc. ($\mu\text{g}/\text{m}^3$)	2nd Hour Conc. ($\mu\text{g}/\text{m}^3$)	3rd Hour Conc. ($\mu\text{g}/\text{m}^3$)
5-Mar-21	10:35	54.8	51.9	52.7
11-Mar-21	10:30	52.7	52.4	53.4
17-Mar-21	13:00	58.5	59.9	60.6
23-Mar-21	10:00	58.5	59.9	61.8
27-Mar-21	11:05	62.9	63.5	61.4
		Average		57.7
		Min		51.9
		Max		63.5

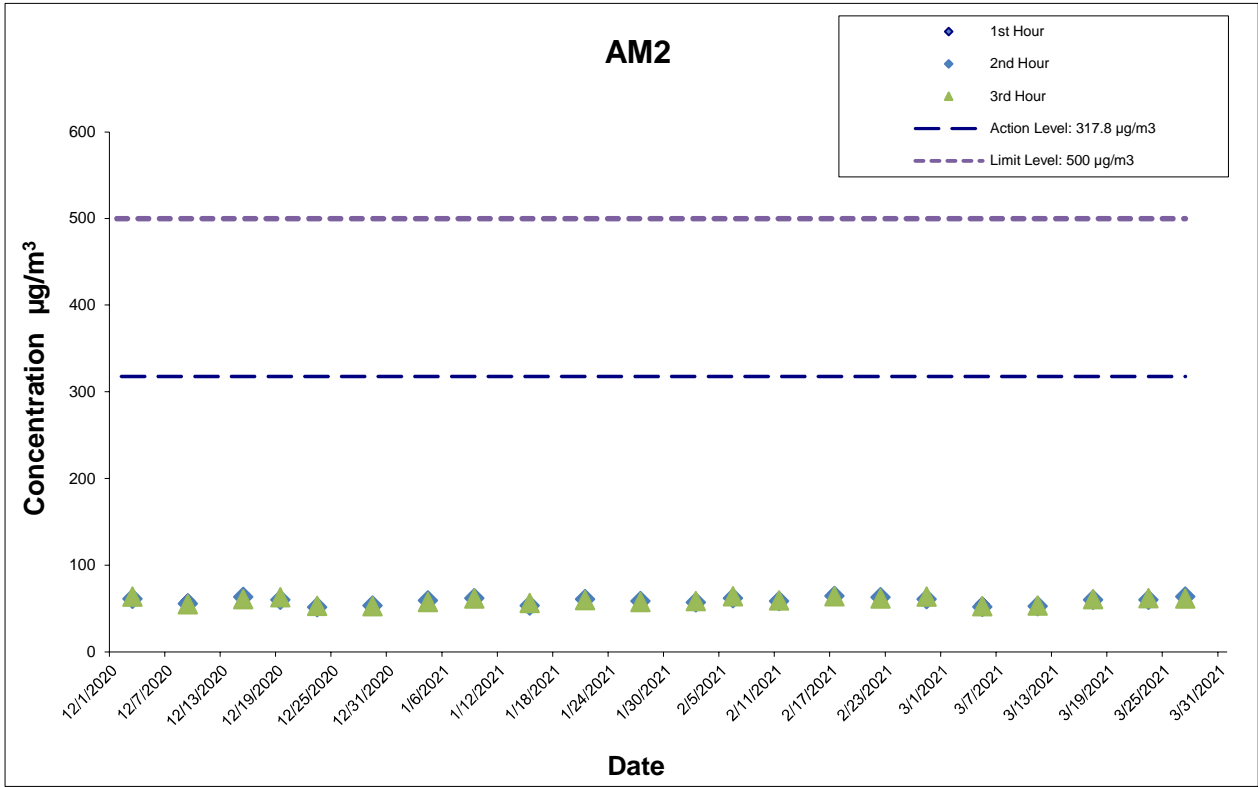

This Drawing has been prepared for the use of AECOM's client. It may not be used, modified, reproduced or relied upon by third parties, except as agreed by AECOM or as required by law. AECOM accepts no responsibility, and denies any liability whatsoever, to any party that uses or relies on this drawing without AECOM's express written consent.

CONTRACT NO. HY/2012/06
 WIDENING OF FANLING HIGHWAY
 - TAI HANG TO WO HOP SHEK INTERCHANGE



Graphical Presentation of Impact 1-hour TSP Monitoring Results

Project No.: 60307376

Date: Apr-21

Appendix G

Appendix G
Impact Air Quality Monitoring Results

24-hour TSP Monitoring Results at Station AM2 (Fanling Government Secondary School)

Date	Weather Condition	Air Temp. (°C)	Atmospheric Pressure(hPa)	Flow Rate (m ³ /min.)		Av. flow (m ³ /min)	Total vol. (m ³)	Filter Weight (g)		Particulate weight(g)	Elapse Time		Sampling Time(hrs.)	Conc. (µg/m ³)	Action Level (µg/m ³)	Limit Level (µg/m ³)
				Initial	Final			Initial	Final		Initial	Final				
5-Mar-21	Cloudy	20.1	1015.9	1.314	1.314	1.314	1892.2	2.7076	2.7903	0.0827	15718.02	15742.02	24.00	43.7	200.7	260
11-Mar-21	Sunny	21.0	1019.8	1.314	1.314	1.314	1892.2	2.7031	2.7556	0.0525	15742.02	15766.02	24.00	27.7	200.7	260
17-Mar-21	Sunny	24.7	1012.9	1.314	1.314	1.314	1892.2	2.6921	2.7530	0.0609	15766.02	15790.02	24.00	32.2	200.7	260
23-Mar-21	Fine	18.9	1020.6	1.314	1.314	1.314	1892.2	2.6898	2.8152	0.1254	15790.02	15814.02	24.00	66.3	200.7	260
27-Mar-21	Sunny	24.1	1012.0	1.314	1.314	1.314	1892.2	2.6884	2.8456	0.1572	15814.02	15838.02	24.00	83.1	200.7	260
													Average	46.7		
													Min	27.4		
													Max	83.1		

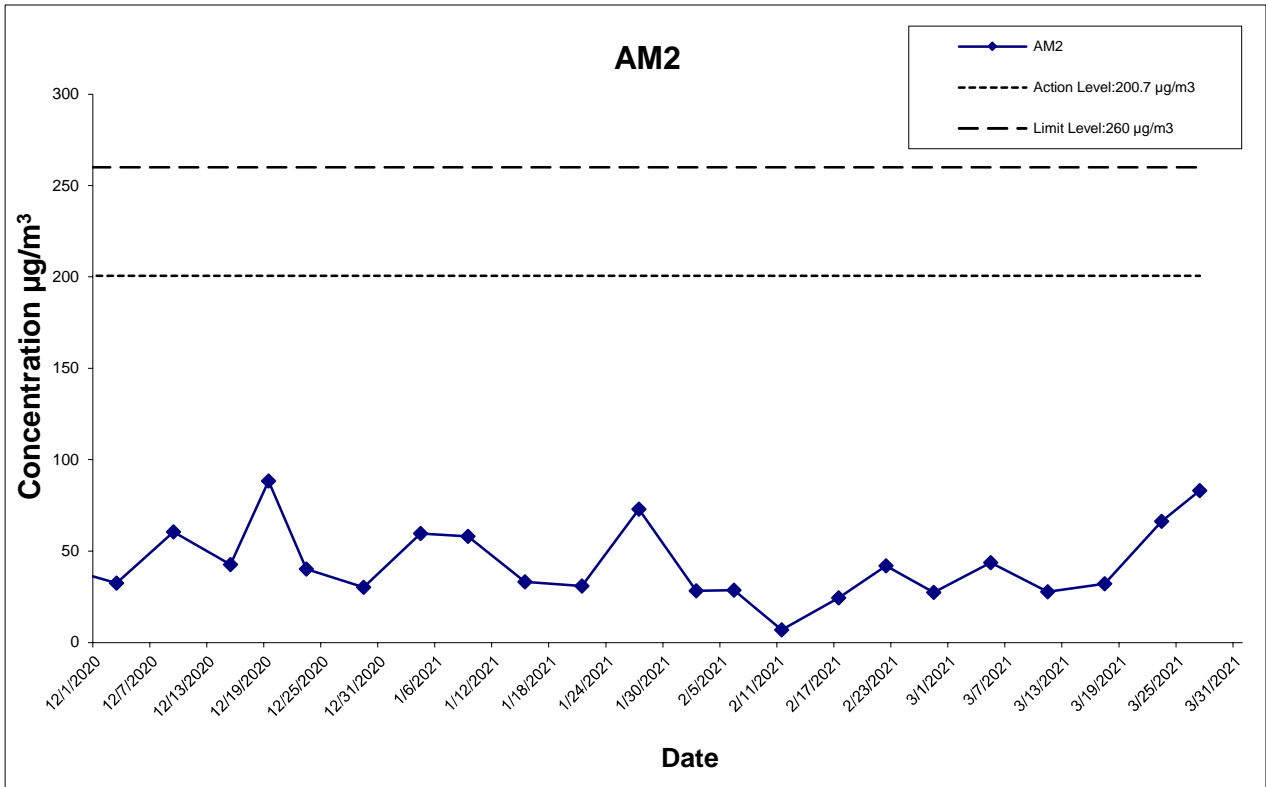

This Drawing has been prepared for the use of AECOM's client. It may not be used, modified, reproduced or relied upon by third parties, except as agreed by AECOM or as required by law. AECOM accepts no responsibility, and denies any liability whatsoever, to any party that uses or relies on this drawing without AECOM's express written consent.

CONTRACT NO. HY/2012/06
 WIDENING OF FANLING HIGHWAY
 - TAI HANG TO WO HOP SHEK INTERCHANGE



Graphical Presentation of Impact 24-hour TSP Monitoring Results

Project No.: 60307376

Date: Apr-21

Appendix G

**APPENDIX H
METEOROLOGICAL DATA FOR THE
REPORTING MONTH**



Home > Climate > Climate Information Service > Daily Extract

Daily Extract

Daily Extract of Meteorological Observations , March 2021

Back Year 2021 Month 3 Go

Day	Hong Kong Observatory								King's Park	Waglan Island [^]	
	Mean Pressure (hPa)	Air Temperature			Mean Dew Point (deg. C)	Mean Relative Humidity (%)	Mean Amount of Cloud (%)	Total Rainfall (mm)	Total Bright Sunshine (hours)	Prevailing Wind Direction (degrees)	Mean Wind Speed (km/h)
		Absolute Daily Max (deg. C)	Mean (deg. C)	Absolute Daily Min (deg. C)							
01	1016.2	25.0	21.9	20.0	18.5	81	78	Trace	5.1	***	**
02	1018.4	25.6	21.4	19.1	16.4	75	59	Trace	8.7	***	**
03	1020.1	19.1	18.4	17.8	15.0	81	88	0.3	0.3	***	**
04	1018.0	19.4	18.9	18.3	16.7	87	93	1.0	0.0	***	**
05	1015.9	21.1	20.1	19.2	18.6	91	88	Trace	0.1	***	**
06	1016.3	21.7	20.5	19.6	19.4	93	93	1.5	0.1	***	**
07	1018.8	20.5	19.9	19.1	18.2	90	88	0.2	0.0	***	**
08	1020.1	22.6	19.7	18.3	16.6	83	83	0.3	3.6	***	**
09	1019.9	22.9	20.1	18.6	16.3	79	55	0.0	4.0	***	**
10	1020.0	21.7	19.8	19.2	16.2	79	87	Trace	1.2	***	**
11	1019.8	24.2	21.0	18.8	17.2	79	64	0.0	7.1	***	**
12	1018.4	27.7	23.2	20.2	18.9	77	32	0.0	10.3	***	**
13	1018.6	24.7	22.0	20.5	17.5	76	57	Trace	6.3	***	**
14	1016.6	23.6	21.3	20.1	17.6	80	76	0.0	3.9	***	**
15	1014.8	26.3	22.4	19.9	17.8	76	46	0.0	9.9	***	**
16	1013.3	28.8	24.0	21.1	19.8	78	22	0.0	10.2	***	**
17	1012.9	28.8	24.7	21.8	20.9	80	42	Trace	10.7	***	**
18	1013.2	26.2	23.4	22.2	21.0	87	81	0.2	3.6	***	**
19	1012.3	27.7	24.2	22.8	20.9	82	55	Trace	9.0	***	**
20	1010.7	29.7	25.0	22.3	21.3	81	32	0.0	10.6	***	**
21	1015.8	24.2	21.2	17.2	16.0	73	80	0.0	0.0	***	**
22	1022.8	20.9	17.8	15.8	10.3	61	87	Trace	1.9	***	**
23	1020.6	20.0	18.9	17.9	11.1	61	88	0.0	0.1	***	**
24	1016.5	23.5	20.7	18.4	14.6	68	86	0.0	3.8	***	**
25	1016.5	25.2	22.1	20.7	16.2	70	45	0.0	9.0	***	**
26	1015.4	25.2	21.6	19.5	16.9	75	65	0.0	6.9	***	**
27	1012.0	28.6	24.1	21.8	20.3	80	62	0.0	7.0	***	**
28	1009.6	28.1	24.8	22.6	21.0	80	46	0.0	8.0	***	**
29	1007.3	28.5	25.6	23.6	22.2	82	81	0.0	5.8	***	**
30	1006.2	29.0	26.6	25.3	22.4	78	81	0.0	3.8	***	**
31	1006.6	29.0	26.5	25.3	22.5	79	86	0.0	2.4	***	**
Mean/Total	1015.6	24.8	22.0	20.2	18.0	79	69	3.5	153.4	***	**
Climatological Normal(1991-2020)	1016.1	21.9	19.5	17.6	16.1	82	77	75.3	100.0	060	23
Climatological Normal(1981-2010)	1016.0	21.4	19.1	17.2	15.7	82	79	82.2	90.8	060	23

*** unavailable
[^] Information of wind direction and wind speed for Waglan Island are based on automatic weather station data since January 1989
 Trace means rainfall less than 0.05 mm

**APPENDIX I
IMPACT DAYTIME CONSTRUCTION NOISE
MONITORING RESULTS AND THEIR
GRAPHICAL PRESENTATION**

Appendix I Impact Daytime Construction Noise Monitoring Results

Location : M2 (West Tai Wo - Free Field)

Day time 07:00-19:00 hrs Normal Weekdays Impact Noise Monitoring Results

Date	Measured Noise Level for 30-min, dB(A)				Limit Level, dB(A)	Exceedance (Y/N)
	Start Time	Leq*	L10*	L90*		
5-Mar-21	11:30	59.7	60.9	58.9	75	N
11-Mar-21	14:00	59.2	59.9	58.1	75	N
17-Mar-21	15:14	67.1	68.5	64.5	75	N
23-Mar-21	10:45	65.8	67.1	64.0	75	N
	Min	59.2	59.9	58.1		
	Max	67.1	68.5	64.5		
	Average	64.3	65.6	62.3		

Location : M3 (Fanling Government Secondary School- Façade)

Day time 07:00-19:00 hrs Normal Weekdays Impact Noise Monitoring Results

Date	Measured Noise Level for 30-min, dB(A)				Limit Level, dB(A)^	Exceedance (Y/N)
	Start Time	Leq*	L10*	L90*		
5-Mar-21	10:30	61.4	62.9	60.3	70	N
11-Mar-21	10:35	61.4	62.1	60.8	70	N
17-Mar-21	13:00	60.2	61.0	55.5	70	N
23-Mar-21	10:45	65.8	67.1	64.0	70	N
	Min	60.2	61.0	55.5		
	Max	65.8	67.1	64.0		
	Average	62.8	64.0	61.1		

* +3dB(A) Façade effect correction included

^ Limit Level of 70dB(A) applies to education institutes while 65dB(A) applies during school examination period.

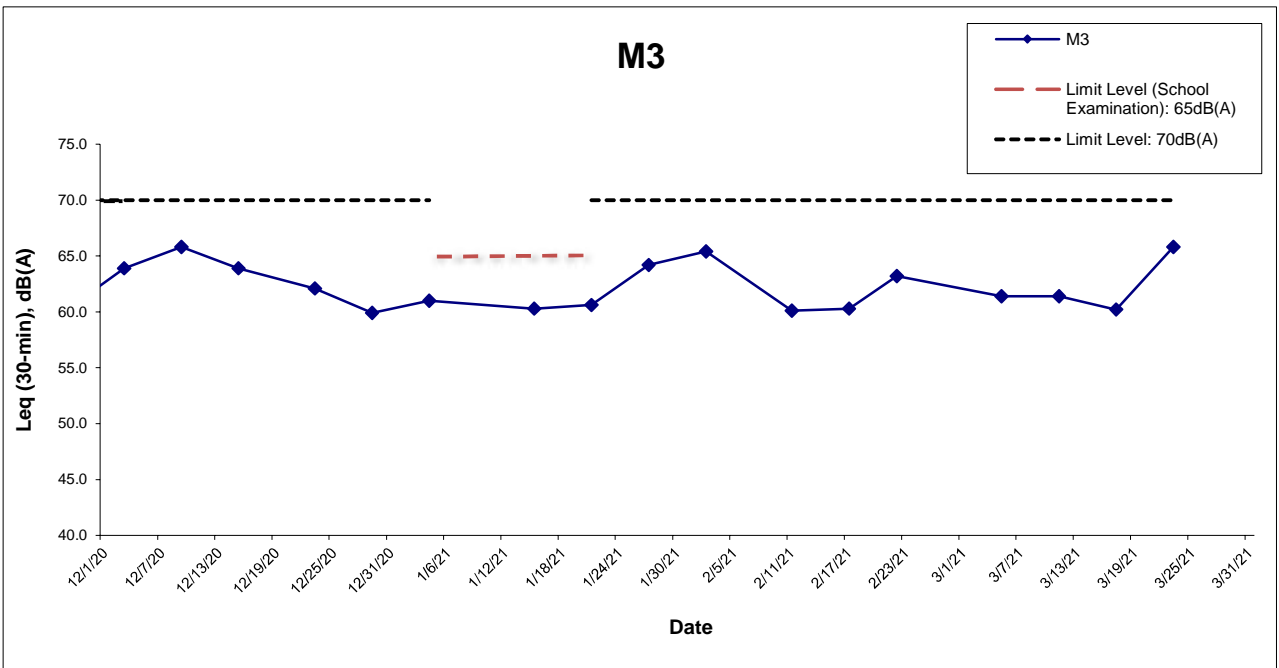
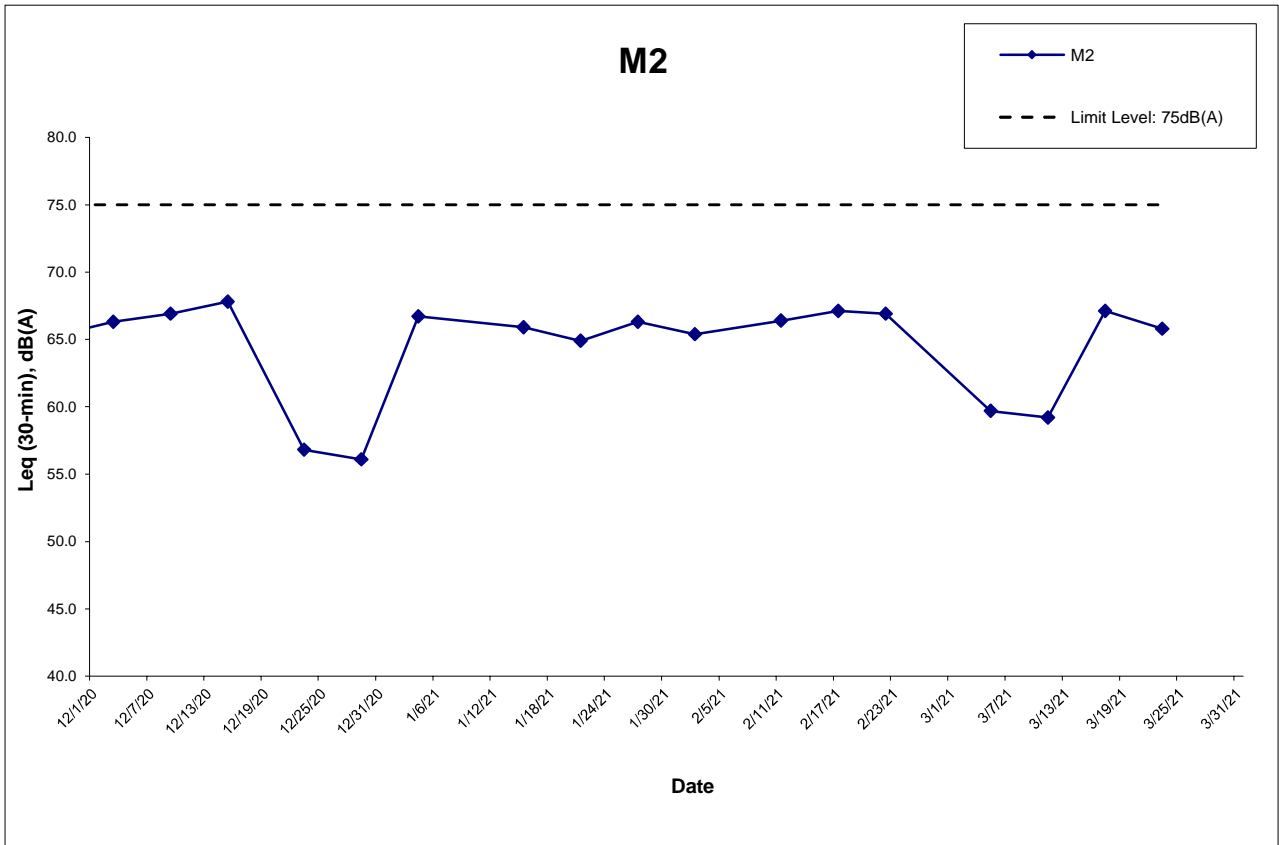

This Drawing has been prepared for the use of AECOM's client. It may not be used, modified, reproduced or relied upon by third parties, except as agreed by AECOM or as required by law. AECOM accepts no responsibility, and denies any liability whatsoever, to any party that uses or relies on this drawing without AECOM's express written consent.

CONTRACT NO. HY/2012/06
 WIDENING OF FANLING HIGHWAY
 - TAI HANG TO WO HOP SHEK INTERCHANGE



Graphical Presentation of Impact Daytime Construction Noise Monitoring Results

Project No.: 60307376

Date: Apr-21

Appendix I

**APPENDIX J
EVENT ACTION PLAN**

Appendix J – Event Action Plan

Event / Action Plan for Air Quality

Event	Action			
	ET Leader	IEC	ER	Contractor
Action Level				
Exceedance for one sample	<ol style="list-style-type: none"> 1. Identify source; 2. Inform IEC and ER; 3. Repeat measurement to confirm finding; 4. Increase monitoring frequency to daily. 	<ol style="list-style-type: none"> 1. Check monitoring data submitted by ET; 2. Check Contractor's working method. 	<ol style="list-style-type: none"> 1. Notify Contractor. 	<ol style="list-style-type: none"> 1. Rectify any unacceptable practice; 2. Amend working methods if appropriate.
Exceedance for two or more consecutive samples	<ol style="list-style-type: none"> 1. Identify source; 2. Inform IEC and ER; 3. Repeat measurements to confirm findings; 4. Increase monitoring frequency to daily; 5. Discuss with IEC and Contractor on remedial actions required; 6. If exceedance continues, arrange meeting with IEC and ER; 7. If exceedance stops, cease additional monitoring. 	<ol style="list-style-type: none"> 1. Check monitoring data submitted by ET; 2. Check Contractor's working method; 3. Discuss with ET and Contractor on possible remedial measures; 4. Advise the ER on the effectiveness of the proposed remedial measures; 5. Supervise Implementation of remedial measures. 	<ol style="list-style-type: none"> 1. Confirm receipt of notification of failure in writing; 2. Notify Contractor; 3. Ensure remedial measures properly implemented. 	<ol style="list-style-type: none"> 1. Submit proposals for remedial actions to IEC within 3 working days of notification; 2. Implement the agreed proposals; 3. Amend proposal if appropriate.

Event / Action Plan for Air Quality

Event Action Level	Action			
	ET Leader	IEC	ER	Contractor
Limit Level				
Exceedance for one sample	<ol style="list-style-type: none"> 1. Identify source; 2. Inform IEC, ER, Contractor and EPD; 3. Repeat measurement to confirm finding; 4. Increase monitoring frequency to daily; 5. Assess effectiveness of Contractor's remedial actions and keep IEC, EPD and ER informed of the results. 	<ol style="list-style-type: none"> 1. Check monitoring data submitted by ET; 2. Check Contractor's working method; 3. Discuss with ET and Contractor on possible remedial measures; 4. Advise ER on the effectiveness of the proposed remedial measures; 5. Supervise implementation of remedial measures. 	<ol style="list-style-type: none"> 1. Confirm receipt of notification of exceedance in writing; 2. Notify Contractor; 3. Ensure remedial measures properly implemented. 	<ol style="list-style-type: none"> 1. Take immediate action to avoid further exceedance; 2. Submit proposals for remedial actions to IEC within 3 working days of notification; 3. Implement the agreed proposals; 4. Amend proposal if appropriate.
Exceedance for two or more consecutive samples	<ol style="list-style-type: none"> 1. Notify IEC, ER, Contractor and EPD; 2. Identify source; 3. Repeat measurement to confirm findings; 4. Increase frequency to daily; 5. Analyse Contractor's working procedures to determine possible mitigation to be; 6. Arrange meeting with IEC and ER to discuss the remedial actions to be taken; 7. Assess effectiveness of Contractor's remedial actions and keep IEC, EPD and ER informed of the results; 8. If exceedance stops, cease additional monitoring. 	<ol style="list-style-type: none"> 1. Discuss amongst ER, ET, and Contractor on the potential remedial actions; 2. Review Contractor's remedial actions whenever necessary to assure their effectiveness and advise ER accordingly; 3. Supervise the implementation of remedial measures. 	<ol style="list-style-type: none"> 1. Confirm receipt of notification of exceedance in writing; 2. Notify Contractor; 3. In consultation with the IEC, agree with the Contractor on the remedial measures to be implemented; 4. Ensure remedial measures properly implemented; 5. If exceedance continues, consider what portion of the work is responsible and instruct the Contractor to stop that portion of work until the exceedance is abated. 	<ol style="list-style-type: none"> 1. Take immediate action to avoid further exceedance; 2. Submit proposals for remedial actions to IEC within 3 working days of notification; 3. Implement the agreed proposals; 4. Resubmit proposals if problem still not under control; 5. Stop the relevant portion of works as determined by ER until the exceedance is abated.

Event / Action Plan for Noise Impact

Event Limit Level	Action			
	ET Leader	IEC	ER	Contractor
Action Level	<ol style="list-style-type: none"> 1. Notify IEC and the Contractor. 2. Carry out investigation. 3. Report the results of investigation to IEC and the Contractor. 4. Discuss with the Contractor and formulate remedial measures. 5. Increase monitoring frequency to check mitigation effectiveness. 	<ol style="list-style-type: none"> 1. Review with analysed results submitted by ET. 2. Review the proposed remedial measures by the Contractor and advise ER accordingly. 3. Supervise the implement of remedial measures. 	<ol style="list-style-type: none"> 1. Confirm receipt of notification of failure in writing. 2. Notify the Contractor. 3. Require the Contractor to propose remedial measures for the analysed noise problem. 4. Ensure remedial measures are properly implemented. 	<ol style="list-style-type: none"> 1. Submit noise mitigation proposals to IEC. 2. Implement noise mitigation proposals.
Limit Level	<ol style="list-style-type: none"> 1. Notify, IEC, ER, EPD and the Contractor. 2. Identify the source. 3. Repeat measurement to confirm findings. 4. Increase monitoring frequency. 5. Carry out analysis of Contractor's working procedures to determine possible mitigation to be implemented. 6. Inform IEC, ER, and EPD the causes & actions taken for the exceedances. 7. Assess effectiveness of the Contractor's remedial actions and keep IEC, EPD and ER informed of the results. 8. If exceedance stops, cease additional monitoring. 	<ol style="list-style-type: none"> 1. Discuss amongst ER, ET Leader and the Contractor on the potential remedial actions. 2. Review the Contractor's remedial actions whenever necessary to assure their effectiveness and advise ER accordingly. 3. Supervise the implementation of remedial measures. 	<ol style="list-style-type: none"> 1. Confirm receipt of notification of failure in writing. 2. Notify the Contractor. 3. Require the Contractor to propose remedial measures for the analysed noise problem. 4. Ensure remedial measures are properly implemented. 5. If exceedance continues, consider what activity of the work is responsible and instruct the Contractor to stop that activity of work until the exceedance is abated. 	<ol style="list-style-type: none"> 1. Take immediate action to avoid further exceedance. 2. Submit proposals for remedial actions to IEC within 3 working days of notification. 3. Implement the agreed proposals. 4. Resubmit proposals if problem still not under control. 5. Stop the relevant activity of works as determined by the ER until the exceedance is abated.

**APPENDIX K
SITE INSPECTION SUMMARIES**

Site Inspection Summary

Inspection Information

Contract No.	HY/2012/06
Date:	2 March 2021
Time:	10:00
Inspection No.:	377

Non-compliance

Nil

Observations

<u>Follow-up Observation(s)</u> Nil
<u>Observation (s)</u> Nil
<u>Reminder (s)</u> No Specific observation was identified in this inspection.

Remarks

Nil

	Name	Signature	Date
Prepared by	Alex Chan		2 March 2021
Checked by	Y W Fung	/	2 March 2021

Site Inspection Summary

Inspection Information

Contract No.	HY/2012/06
Date:	09 March 2021
Time:	14:00
Inspection No.:	378

Non-compliance

Nil

Observations

<u>Follow-up Observation(s)</u>
Nil
<u>Observation (s)</u>
Nil
<u>Reminder (s)</u>
Nil

Remarks

Nil

	Name	Signature	Date
Prepared by	Alex Chan		09 March 2021
Checked by	Y W Fung	/	09 March 2021

Site Inspection Summary

Inspection Information

Contract No.	HY/2012/06
Date:	16 March 2021
Time:	14:00
Inspection No.:	379

Non-compliance

Nil

Observations

<u>Follow-up Observation(s)</u>
Nil
<u>Observation (s)</u>
Nil
<u>Reminder (s)</u>
Nil

Remarks

Nil

	Name	Signature	Date
Prepared by	Alex Chan		16 March 2021
Checked by	Y W Fung	/	16 March 2021

Site Inspection Summary

Inspection Information

Contract No.	HY/2012/06
Date:	23 March 2021
Time:	14:00
Inspection No.:	380

Non-compliance

Nil

Observations

	<u>Follow-up Observation(s)</u> Nil
	<u>Observation (s)</u> 1. Chemical waste containers stored without drip tray was observed at demolishing site office. The Contractor was advised to provide a drip tray to the chemical waste stored onsite.
	<u>Reminder (s)</u> Nil

Remarks

Nil

	Name	Signature	Date
Prepared by	Alex Chan		23 March 2021
Checked by	Y W Fung	/	23 March 2021

Site Inspection Summary

Inspection Information

Contract No.	HY/2012/06
Date:	31 March 2021
Time:	14:00
Inspection No.:	381

Non-compliance

Nil

Observations

	<u>Follow-up Observation(s)</u>
1.	The improper stored chemical waste containers were removed. (closed)
	<u>Observation (s)</u>
	No specific observation was identified in this inspection.
	<u>Reminder (s)</u>
	Nil

Remarks

Nil

	Name	Signature	Date
Prepared by	Alex Chan		31 March 2021
Checked by	Y W Fung	/	31 March 2021

**APPENDIX L
STATISTICS ON COMPLAINTS,
NOTIFICATION OF SUMMONS AND
SUCCESSFUL PROSECUTIONS**

Appendix L

Statistics on Complaints, Notifications of Summons and Successful Prosecutions

Contract No. HY/2012/06 – Widening of Fanling Highway – Tai Hang to Wo Hop Shek Interchange

	Date Received	Subject	Status	Total no. followed up by the ET this month	Total no. followed up by the ET since project commencement
Environmental complaints	19 December 2013	EPD referred a complaint from Lot no. 116 of Fui Sha Wai at Tai Hang of Tai Po which is concerned about the construction noise and diesel-like smell generated from construction activities nearby which caused nuisance and health problems on 19 December 2013 morning.	Closed	0	10
	24 February 2014	EPD referred an air-and-odour complaint on 24 February 2014. The complainant complained about the construction site located near the bus stop in Fui Sha Wai, Tai Hang, Tai Wo Service Road West. When construction works were carried out, odour, white smoke and dust were generated. The complainant asked for follow-up actions.	Closed		
	23 October 2014	EPD referred an air complaint on 24 October 2014. A resident complained against the excavation works of Tai Wo Service Road West between Nam Wah Po & Tai Hang Tsuen, which have piled up high stockpiles, causing serious dust nuisance to his house.	Closed		

Date Received	Subject	Status	Total no. followed up by the ET this month	Total no. followed up by the ET since project commencement
	<p>The resident also complained that the stockpiles have not been covered and watered properly. He now requires the EPD to follow up.</p> <p>The location of complaint is near Lamppost Location EB5717.</p>			
31 December 2014	<p>EPD referred a water complaint on 31 December 2014.</p> <p>The complainant complained about the muddy river outside Tai Hang Village Office on 29 December 2014. It was suspected that the muddy water was discharged from the construction works of the Project.</p> <p>He required the EPD to follow up.</p>	Closed		
25 March 2015	<p>EPD referred a water complaint on 25 March 2015.</p> <p>The complainant complained about the generation of the smell of gasoline from the Widening of Fanling Highway construction site on Tai Wo Service Road West, causing serious nuisance to nearby houses.</p> <p>The situation has continued for a few weeks and she asked the EPD to follow up as soon as possible.</p>	Closed		

Date Received	Subject	Status	Total no. followed up by the ET this month	Total no. followed up by the ET since project commencement
5 January 2017 (Referred by the Contractor on 13 January 2017)	<p>A complaint was received by the 1823 enquiry and complaint hotline on 5 January 2017. The complaint was referred to the Environmental Team by the Contractor on 13 January 2017.</p> <p>The complainant complained against the dust emission generated by the Widening of Fanling Highway construction site on Tai Wo Service Road West near Tai Hang Village.</p> <p>The complainant also complained that Highway Department did not conduct road surface cleansing, which affects residents' health. He/she now requires the Highway Department to follow up.</p>	Closed		
22 May 2017 (Referred by the Contractor on 23 May 2017)	<p>A complaint was received by the 1823 enquiry and complaint hotline on 22 May 2017. The complaint was referred to the Environmental Team by the Contractor on 23 May 2017.</p> <p>A complainant complained that construction noise was caused by the erection of noise barrier on Tai Wo Service Road West near Tai Hang Village on Sunday(s).</p> <p>The complainant concerned about if any Construction Noise Permit is issued by the Environmental Protection Department.</p>	Closed		

Date Received	Subject	Status	Total no. followed up by the ET this month	Total no. followed up by the ET since project commencement
25 February 2018 (Referred by the Contractor on 1 March 2018)	<p>The 1823 enquiry and complaint hotline received a complaint on 25 February 2018. The complaint was referred to the Environmental Team by the Contractor on 1 March 2018.</p> <p>A complainant complained that noise nuisance was caused continuously by road construction works at Fanling Highway near Tai Hang Village during 01:30 to 04:00 on 25 February 2018. The complainant concerned that the nuisance affects residence and asked for follow-up action from the related department.</p>	Closed		
28 September 2019 (Referred by the EPD on 28 October 2019)	<p>The EPD received a complaint on 28 October 2019. The complaint was referred to the Environmental Team by the Contractor on 28 October 2019.</p> <p>The complainant was regarded to the use of powered mechanical equipment not in accordance with the conditions stipulated in the Construction Noise Permit (CNP) - GW-RN0602-19 in Pak Wo Road near Fanling Highway on 24 September 2019.</p> <p>The complainant concerned about if any Construction Noise Permit is issued by the Environmental Protection Department.</p>	Closed		

	Date Received	Subject	Status	Total no. followed up by the ET this month	Total no. followed up by the ET since project commencement
	28 October 2019 (Referred by the EPD on 14 November 2019)	The Buildings Department received a complaint on 28 October 2019 through email. The complaint was referred to Environmental Team of HY/2012/06 on 14 November 2019. The complainant complained about dust and noise nuisance caused continuously by road construction works at Tai Wo Service Road West.	Closed		
Notification of summons	-	-	-	0	0
Successful Prosecutions	-	-	-	0	0

Contract No. 02/HY/2015 – Provision of Bus-Bus Interchange on Fanling Highway Kowloon Bound

	Date Received	Subject	Status	Total no. followed up by the ET this month	Total no. followed up by the ET since project commencement
Environmental complaints	-	-	-	0	0
Notification of summons	-	-	-	0	0
Successful Prosecutions	-	-	-	0	0