

**Environmental Protection Department**

Contract No. HY/2012/06

**Widening of Fanling Highway  
– Tai Hang to Wo Hop Shek  
Interchange****Monthly EM&A Report  
For August 2020**

[09/2020]

|                      | Name      | Signature   |
|----------------------|-----------|---|
| Prepared & Checked:  | Alex Chan |  |
| Reviewed & Approved: | Y W Fung  |  |

Version: Rev. 0 Date: 9 September 2020

**Disclaimer**

This report is prepared for Environmental Protection Department and is given for its sole benefit in relation to and pursuant to Contract No. HY/2012/06 and may not be disclosed to, quoted to or relied upon by any person other than Environmental Protection Department without our prior written consent. No person (other than Environmental Protection Department) into whose possession a copy of this report comes may rely on this report without our express written consent and Environmental Protection Department may not rely on it for any purpose other than as described above.

AECOM Asia Co. Ltd.  
12/F, Grand Central Plaza, Tower 1, 138 Shatin Rural Committee Road, Shatin, NT, Hong Kong  
Tel: (852) 3922 9000 Fax: (852) 2317 7609 www.aecom.com

Hyder-Arup-Black & Veatch Joint Venture  
c/o Arcadis  
17/F, Two Harbour Square,  
180 Wai Yip Street,  
Kwun Tong, Hong Kong  
Attn: Mr. James Penny

**Your Reference**

**Our Reference**

AFK/EC/ST/cy/T329380/2  
2.05/L-0342

3/F International Trade  
Tower  
348 Kwun Tong Road  
Kowloon  
Hong Kong

T +852 2828 5757  
F +852 2827 1823  
mottmac.hk

**Environmental Monitoring and Audit (EM&A) for Widening of Tolo Highway/Fanling Highway between Island House Interchange and Fanling Stage 2 (between Tai Hang to Wo Hop Shek Interchange)**  
**Environmental Permit No. EP-324/2008/E Condition 3.3 – Submission of Monthly EM&A Report – August 2020 for the portion of Stage 2 works under Contract No. HY/2012/06**

8 September 2020

By Fax (2805 5028) & Hand

We refer to the Monthly EM&A Report – August 2020 received on 7 September 2020 submitted by the Environmental Team via email. Pursuant to Environmental Permit Condition 3.3, I hereby verify the Monthly EM&A Report – August 2020 for the portion of works under Stage 2 of the captioned Project which is managed under Contract No. HY/2012/06.

Yours faithfully  
for MOTT MACDONALD HONG KONG LIMITED



Steven Tang  
Independent Environmental Checker

c.c.

HyD  
AECOM

Mr. Ricky Yeung  
Mr. Y W Fung

By Fax (2714 5198)  
By Fax (3922 9797)

## TABLE OF CONTENTS

|  | Page |
|--|------|
| EXECUTIVE SUMMARY  | 3    |
| 1 INTRODUCTION   | 5    |
| 1.1 Background   | 5    |
| 1.2 Scope of Report  | 6    |
| 1.3 Project Organization   | 6    |
| 1.4 Summary of Construction Works  | 7    |
| 1.5 Summary of EM&A Programme Requirements                                     | 7    |
| 2 AIR QUALITY MONITORING   | 8    |
| 2.1 Monitoring Requirements  | 8    |
| 2.2 Monitoring Equipment   | 8    |
| 2.3 Monitoring Locations   | 8    |
| 2.4 Monitoring Parameters and Frequency  | 8    |
| 2.5 Monitoring Methodology   | 9    |
| 2.6 Monitoring Schedule for the Reporting period                               | 10   |
| 2.7 Results and Observations   | 11   |
| 3 NOISE MONITORING   | 12   |
| 3.1 Monitoring Requirements  | 12   |
| 3.2 Monitoring Equipment   | 12   |
| 3.3 Monitoring Locations   | 12   |
| 3.4 Monitoring Parameters and Frequency  | 12   |
| 3.5 Monitoring Methodology   | 13   |
| 3.6 Monitoring Schedule for the Reporting period                               | 13   |
| 3.7 Monitoring Results   | 14   |
| 4 ENVIRONMENTAL SITE INSPECTION AND AUDIT                                      | 15   |
| 4.1 Site Inspection  | 15   |
| 4.2 Advice on the Solid and Liquid Waste Management Status                     | 16   |
| 4.3 Environmental Licenses and Permits   | 17   |
| 4.4 Implementation Status of Environmental Mitigation Measures                 | 18   |
| 4.5 Summary of Exceedances of the Environmental Quality Performance Limit      | 18   |
| 4.6 Summary of Complaints, Notification of Summons and Successful Prosecutions | 18   |
| 5 FUTURE KEY ISSUES  | 19   |
| 5.1 Construction Programme for the Coming Months                               | 19   |
| 5.2 Key Issues for the Coming Month  | 19   |
| 5.3 Monitoring Schedule for the Coming Month                                   | 19   |
| 6 CONCLUSIONS AND RECOMMENDATIONS  | 20   |
| 6.1 Conclusions  | 20   |
| 6.2 Recommendations  | 20   |

## List of Tables

|           |  |
|-----------|--|
| Table 1.1 | Contact Information of Key Personnel                                     |
| Table 2.1 | Air Quality Monitoring Equipment   |
| Table 2.2 | Locations of Impact Air Quality Monitoring Station                       |
| Table 2.3 | Air Quality Monitoring Parameters and Frequency                          |
| Table 2.4 | Summary of 1-hour TSP Monitoring Results in the Reporting Period         |
| Table 2.5 | Summary of 24-hour TSP Monitoring Results in the Reporting Period        |
| Table 3.1 | Noise Monitoring Equipment   |
| Table 3.2 | Locations of Impact Noise Monitoring Stations                            |
| Table 3.3 | Noise Monitoring Parameters, Frequency and Duration                      |
| Table 3.4 | Summary of Construction Noise Monitoring Results in the Reporting Period |
| Table 4.1 | Summary of Waste Flow Table for Contract No. HY/2012/06                  |
| Table 4.2 | Summary of Environmental Licensing and Permit Status                     |

## Figures

|               |   |
|---------------|---|
| Figure 1.1    | General Project Layout Plan of Contract No. HY/2012/06  |
| Figure 1.2    | General Project Layout Plan of Contract No. 02/HY/2015 (Works Order Nos. CB128520-5 and CB128519-0) |
| Figure 1.3a-b | Locations of Monitoring Station   |
| Figure 4.1    | Environmental Complaint Handling Procedures   |

## List of Appendices

|            |   |
|------------|---|
| Appendix A | Project Organization Structure  |
| Appendix B | Construction Programme  |
| Appendix C | Implementation Schedule of Environmental Mitigation Measures (EMIS)                   |
| Appendix D | Summary of Action and Limit Levels  |
| Appendix E | Calibration Certificates of Monitoring Equipments                                     |
| Appendix F | EM&A Monitoring Schedules   |
| Appendix G | Impact Air Quality Monitoring Results and their Graphical Presentation                |
| Appendix H | Meteorological Data for the Reporting period  |
| Appendix I | Impact Daytime Construction Noise Monitoring Results and their Graphical Presentation |
| Appendix J | Event Action Plan   |
| Appendix K | Site Inspection Summaries   |
| Appendix L | Statistics on Complaints, Notifications of Summons and Successful Prosecutions        |



## EXECUTIVE SUMMARY

The proposed widening of Tolo Highway and Fanling Highway between Island House Interchange and Fanling (the Project) is a Designated Project under the Environmental Impact Assessment Ordinance (Cap. 499) (EIAO). An Environmental Impact Assessment (EIA) Report (the approved EIA Report) together with an Environmental Monitoring and Audit (EM&A) Manual (the approved EM&A Manual) were completed and approved under the EIAO on 14 July 2000 (Register Number: EIA-043/2000).

The objective of the Project “Widening of Tolo Highway / Fanling Highway between Island House Interchange and Fanling” is to widen Tolo Highway and Fanling Highway to dual 4-lane carriageway in order to alleviate the current traffic congestion problems and to cope with the increasing transport demands to and from the urban areas and also cross boundary traffic.

The Project is a designated project and governed by an Environmental Permit (EP-324/2008) issued by the EPD on 23 December 2008. Subsequently, the EPD issued Variation of Environmental Permits of EP-324/2008/A, EP-324/2008/B, EP-324/2008/C and EP-324/2008/D on 31 January 2012, 17 March 2014, 27 March 2015 and 27 August 2015 respectively. The current valid VEP was applied on 29 December 2016 and the VEP (EP-324/2008/E) was subsequently granted on 26 January 2017.

The construction works for this Project are delivered in 2 stages i.e. Stage 1 (between Island House Interchange and Tai Hang) and Stage 2 (between Tai Hang and Wo Hop Shek Interchange). Stage 2 would be implemented under three works contracts. Contract No. HY/2012/06 “Widening of Fanling Highway – Tai Hang to Wo Hop Shek Interchange” and the entrusted portion to CEDD under Contract No. CV/2012/09 “Liantang/Heung Yuen Wai Boundary Control Point Site Formation and Infrastructure Works – Contract 3”. In addition, Contract No. “Provision of Bus-Bus Interchange on Fanling Highway Kowloon Bound” was carried out within the site boundary of Contract No. 02/HY/2015. This report focuses on Contract No. HY/2012/06 “Widening of Fanling Highway – Tai Hang to Wo Hop Shek Interchange” in Stage 2 of the Project and “Provision of Bus-Bus Interchange on Fanling Highway Kowloon Bound” under Works Order Nos. CB128520-5 and CB128519-0 in Contract No. 02/HY/2015 “Highway Department Term Contract (Management and Maintenance of Roads in Tai Po and North District excluding High Speed Roads 2016-2022)”. The construction works of Works Order Nos. CB128520-5 and CB128519-0 under Contract No. 02/HY/2015 have been completed on 23 May 2018.

Pursuant to the EP (EP-324/2008/E) Condition 2.7, the Capture Survey Trip Report for Ma Wat River Northern Meander (Version 2) for the Project was submitted on 24 December 2013 by the Environmental Team (ET) and verified by the Independent Environmental Checker (IEC) on 6 January 2014.

The construction phase of the Contract under the EP and the Environmental Monitoring and Audit (EM&A) programme of the contract commenced on 21 November 2013. The impact environmental monitoring and audit includes air quality and noise monitoring.

This report documents the findings of EM&A works conducted in the period between 1 and 31 August 2020. As informed by the Contractor, construction activities of Contract No. HY/2012/06 in the reporting period were:

- Site clearance;
- Excavation;
- Backfilling;
- Road resurfacing;
- Landscape works.

### **Reporting Change**

There was no reporting change required in the reporting period.

### **Breaches of Action and Limit Levels for Air Quality**

No exceedance of Action and Limit Level was recorded for 1-hour and 24-hour TSP monitoring in the reporting period.

### **Breaches of Action and Limit Levels for Noise**

No Action or Limit Level exceedance of construction noise was recorded in the reporting month. No noise complaints related to 0700 – 1900 hours on normal weekdays was received and followed by Environmental Team in the reporting month.

### **Complaint, Notification of Summons and Successful Prosecution**

No complaint, notification of summons and successful prosecution was received in the reporting period.

### **Future Key Issues**

Key issues to be considered in the coming month include:

- Properly store and label oils and chemicals on site;
- Chemical, chemical waste and waste management;
- Collection of construction waste should be carried out regularly;
- Properly maintain all drainage facilities and wheel washing facilities on site;
- Exposed slopes should be covered up properly if no temporary work will be conducted;
- Quieter powered mechanical equipment should be used;
- Suppress dust generated from excavation activities and haul road traffic; and
- Tree protective measures for all retained trees should be well maintained.

## 1 INTRODUCTION

### 1.1 Background

- 1.1.1. Tolo Highway and Fanling Highway are the expressways in the North East New Territories (NENT) connecting Sha Tin, Tai Po and Fanling. These highways form a vital part of the strategic Route 9, which links Hong Kong Island to the boundary at Shenzhen. At present, this section of Route 9 is a dual 3-lane carriageway. However, at several major interchanges along this section of Route 9, the highway is a dual-2 lane carriageway only. Severe congestion is a frequent occurrence during the peak periods, particularly in the Kowloon-bound direction.
- 1.1.2. The objective of the Project “Widening of Tolo Highway / Fanling Highway between Island House Interchange and Fanling” is to widen Tolo Highway and Fanling Highway to dual 4-lane carriageway in order to alleviate the current traffic congestion problems and to cope with the increasing transport demands to and from the urban areas and also cross boundary traffic.
- 1.1.3. The Project is a designated project and governed by an Environmental Permit (EP-324/2008) issued by the EPD on 23 December 2008. Subsequently, the EPD issued Variation of Environmental Permits of EP-324/2008/A, EP-324/2008/B, EP-324/2008/C and EP-324/2008/D on 31 January 2012, 17 March 2014, 27 March 2015 and 27 August 2015 respectively. The current valid VEP was applied on 29 December 2016 and the VEP (EP-324/2008/E) was subsequently granted on 26 January 2017.
- 1.1.4. The scope of the Project comprises mainly:
- (i) Widening of a 5.7 km section of Tolo Highway and 3.0 km section of Fanling Highway between Island House Interchange and Wo Hop Shek Interchange from the existing dual 3-lane to dual 4-lane, including construction of new vehicular bridges;
  - (ii) Widening of interchange sections at Island House Interchange, Tai Po North Interchange, and Lam Kam Road Interchange from dual 2-lane to dual 3-lane, except Sha Tin bound carriageway at Tai Po North Interchange, which is widened from 3-lane to 4-lane, including realignment of various slip roads;
  - (iii) Modification and reconstruction of highways, vehicular bridges, underpasses and footbridges.
- 1.1.5. The construction works for this Project will be delivered in 2 stages i.e. Stage 1 (between Island House Interchange and Tai Hang) and Stage 2 (between Tai Hang and Wo Hop Shek Interchange). Stage 2 would be implemented under two works contracts. Contract No. HY/2012/06 “Widening of Fanling Highway – Tai Hang to Wo Hop Shek Interchange” and the entrusted portion to CEDD under Contract No. CV/2012/09 “Liantang/Heung Yuen Wai Boundary Control Point Site Formation and Infrastructure Works – Contract 3”. In addition, Contract No. “Provision of Bus-Bus Interchange on Fanling Highway Kowloon Bound” was carried out within the site boundary of Contract No. 02/HY/2015. This report focuses on Contract No. HY/2012/06 “Widening of Fanling Highway – Tai Hang to Wo Hop Shek Interchange” in Stage 2 of the Project and “Provision of Bus-Bus Interchange on Fanling Highway Kowloon Bound” under Works Order Nos. CB128520-5 and CB128519-0 in Contract No. 02/HY/2015 “Highway Department Term Contract (Management and Maintenance of Roads in Tai Po and North District excluding High Speed Roads 2016-2022)”.
- 1.1.6. Hyder-Arup-Black and Veatch Joint Venture (HABVJV) are appointed by Highways Department (HyD) as the consultants for the design and construction assignment for the Tolo project under Agreement No. CE 58/2000 Supplementary Agreement No. 3 (SA3) (i.e. the Engineer for Contract No. HY/2012/06).
- 1.1.7. China State Construction Engineering (Hong Kong) Ltd. (CSHK) was commissioned as the Contractor of Contract No. HY/2012/06. Chiu Hing Construction & Transportation Company Limited (Chiu Hing) was commissioned as the Contractor of Contract No. 02/HY/2015. The construction works of Works Order Nos. CB128520-5 and CB128519-0 under Contract No. 02/HY/2015 have been completed on 23 May 2018.

1.1.8. AECOM Asia Co. Ltd. was commissioned by China State Construction Engineering (Hong Kong) Limited as the Environmental Team (ET) to undertake the Environmental Monitoring and Audit (EM&A) works for the Contract and Mott MacDonald Hong Kong Ltd. acts as the Independent Environmental Checker (IEC) for the Contract.

1.1.9. The construction phase of the Contract under the EP commenced on 21 November 2013.

1.1.10. According to the updated EM&A Manual of Stage 2 of the Project, there is a need of an EM&A programme including air quality and noise monitoring. The EM&A programme for Stage 2 of the Project commenced on 21 November 2013.

## 1.2 Scope of Report

1.2.1 This is the eighty-third monthly EM&A Report under the Contract No. HY/2012/06 “Widening of Fanling Highway – Tai Hang to Wo Hop Shek Interchange. This report presents a summary of the environmental monitoring and audit works, list of activities and mitigation measures proposed by the ET for the Contract in August 2020.

## 1.3 Project Organization

1.3.1 The project organization structure is shown in Appendix A. The key personnel contact names and numbers are summarized in Table 1.1.

**Table 1.1 Contact Information of Key Personnel**

| Party   | Position                          | Name          | Telephone | Fax       |
|---|-----------------------------------|---------------|-----------|-----------|
| <b>ER</b><br>(Hyder-Arup-Black & Veatch Joint Venture)  | Chief Resident Engineer           | Edwin Chung   | 6115 0818 | 2638 0950 |
| <b>IEC</b><br>(Mott MacDonald Hong Kong Limited)  | Independent Environmental Checker | Steven Tang   | 2828 5920 | 2827 1823 |
| <b>Contractor of [HY/2012/06]</b><br><br>(China State Construction Engineering (Hong Kong) Limited) | Environmental Officer             | Michael Tsang | 9277 4956 | 2672 2501 |
|   |                                   | C C Chow      | 9679 6315 | 2672 2501 |
| <b>Contractor of [02/HY/2015]</b><br><br>(Chiu Hing Construction & Transportation Company Limited)  | Safety Officer                    | Marty Tai     | 9106 5318 | -         |

| <b>Party</b>                                 | <b>Position</b> | <b>Name</b> | <b>Telephone</b> | <b>Fax</b> |
|--|-----------------|-------------|------------------|------------|
| <b>ET</b><br>(AECOM Asia<br>Company Limited) | ET Leader       | Y W Fung    | 3922 9393        | 3922 9797  |

#### **1.4 Summary of Construction Works**

- 1.4.1 The construction phase for the Contract under the EP commenced on 21 November 2013.
- 1.4.2 Details of the construction works of Contract No. HY/2012/06 carried out by the Contractor in this reporting period are listed below:
- Site clearance
  - Excavation
  - Backfilling
  - Road resurfacing
  - Landscape works
- 1.4.3 The Construction Programme is shown in Appendix B.
- 1.4.4 The general layout plan of the Project site of Contract No. HY/2012/06 and Works Order Nos. CB128520-5 and CB128519-0 under 02/HY/2015 showing the contract areas are shown in Figure 1.1 and Figure 1.2 respectively.
- 1.4.5 The environmental mitigation measures implementation schedule are presented in Appendix C .

#### **1.5 Summary of EM&A Programme Requirements**

- 1.5.1 The EM&A programme required environmental monitoring for air quality, noise and environmental site inspections for air quality, water quality, noise, waste management, ecology, and landscape and visual impact. The EM&A requirements for each parameter described in the following sections include:-
- All monitoring parameters;
  - Monitoring schedules for the reporting period and forthcoming months;
  - Action and Limit levels for all environmental parameters;
  - Event / Action Plan;
  - Environmental mitigation measures, as recommended in the Project EIA study final report; and
  - Environmental requirement in contract documents.

## 2 AIR QUALITY MONITORING

### 2.1 Monitoring Requirements

2.1.1 In accordance with the updated EM&A Manual, baseline 1-hour and 24-hour TSP levels at one air quality monitoring station was established. Impact 1-hour TSP monitoring was conducted for at least three times every 6 days, while impact 24-hour TSP monitoring was carried out for at least once every 6 days. The Action and Limit level of the air quality monitoring is provided in Appendix D.

### 2.2 Monitoring Equipment

2.2.1 24-hour TSP air quality monitoring was performed using High Volume Sampler (HVS) located at each designated monitoring station. The HVS meets all the requirements of the updated EM&A Manual. Portable direct reading dust meters were used to carry out the 1-hour TSP monitoring. Brand and model of the equipment is given in Table 2.1.

**Table 2.1 Air Quality Monitoring Equipment**

| Equipment                                       | Brand and Model  |
|---|--|
| Portable direct reading dust meter (1-hour TSP) | Sibata Digital Dust Monitor (Model No. LD-3)   |
| High Volume Sampler (24-hour TSP)               | Tisch Total Suspended Particulate Mass Flow Controlled High Volume Air Sampler (Model No. TE-5170) |

### 2.3 Monitoring Locations

2.3.1 The monitoring station was set up at the proposed location in accordance with updated EM&A Manual. Table 2.2 describes details of the monitoring station. The locations are shown in Figure 1.3a.

**Table 2.2 Locations of Impact Air Quality Monitoring Station**

| Location  | Monitoring Station                  |
|-----------|-------------------------------------|
| AM2 (SR2) | Fanling Government Secondary School |

### 2.4 Monitoring Parameters and Frequency

2.4.1 Table 2.3 summarizes the monitoring parameters, frequency and duration of impact TSP monitoring.

**Table 2.3 Air Quality Monitoring Parameters and Frequency**

| Parameter   | Frequency   |
|-------------|---|
| 24-hour TSP | Once every 6 days   |
| 1-hour TSP  | 3 times every 6 days while the highest dust impact was expected |

## 2.5 Monitoring Methodology

### 2.5.1 24-hour TSP Monitoring

- (a) The HVS was installed in the vicinity of the air sensitive receivers. The following criteria were considered in the installation of the HVS.
- (i) A horizontal platform with appropriate support to secure the sampler against gusty wind was provided.
  - (ii) The distance between the HVS and any obstacles, such as buildings, was at least twice the height that the obstacle protrudes above the HVS.
  - (iii) A minimum of 2 meters separation from walls, parapets and penthouse for rooftop sampler.
  - (iv) A minimum of 2 meters separation from any supporting structure, measured horizontally.
  - (v) No furnace or incinerator flues nearby.
  - (vi) Airflow around the sampler was unrestricted.
  - (vii) Permission was obtained to set up the samplers and access to the monitoring stations.
  - (viii) A secured supply of electricity was obtained to operate the samplers.
  - (ix) The sampler was located more than 20 meters from any dripline.
  - (x) Any wire fence and gate, required to protect the sampler, did not obstruct the monitoring process.
  - (xi) Flow control accuracy was kept within  $\pm 2.5\%$  deviation over 24-hour sampling period.
- (b) Preparation of Filter Papers
- (i) Glass fibre filters, G810 were labelled and sufficient filters that were clean and without pinholes were selected.
  - (ii) All filters were equilibrated in the conditioning environment for 24 hours before weighing. The conditioning environment temperature was around 25 °C and not variable by more than  $\pm 3$  °C; the relative humidity (RH) was < 50% and not variable by more than  $\pm 5\%$ . A convenient working RH was 40%.
  - (iii) All filter papers were prepared and analysed by ALS Technichem (HK) Pty Ltd., which is a HOKLAS accredited laboratory and has comprehensive quality assurance and quality control programmes.
- (c) Field Monitoring
- (i) The power supply was checked to ensure the HVS works properly.
  - (ii) The filter holder and the area surrounding the filter were cleaned.
  - (iii) The filter holder was removed by loosening the four bolts and a new filter, with stamped number upward, on a supporting screen was aligned carefully.
  - (iv) The filter was properly aligned on the screen so that the gasket formed an airtight seal on the outer edges of the filter.
  - (v) The swing bolts were fastened to hold the filter holder down to the frame. The pressure applied was sufficient to avoid air leakage at the edges.
  - (vi) Then the shelter lid was closed and was secured with the aluminum strip.
  - (vii) The HVS was warmed-up for about 5 minutes to establish run-temperature conditions.
  - (viii) A new flow rate record sheet was set into the flow recorder.
  - (ix) On site temperature and atmospheric pressure readings were taken and the flow rate of the HVS was checked and adjusted at around 1.1 m<sup>3</sup>/min, and complied with the range specified in the updated EM&A Manual (i.e. 0.6-1.7 m<sup>3</sup>/min).
  - (x) The programmable digital timer was set for a sampling period of 24 hrs, and the starting time, weather condition and the filter number were recorded.
  - (xi) The initial elapsed time was recorded.
  - (xii) At the end of sampling, on site temperature and atmospheric pressure readings were taken and the final flow rate of the HVS was checked and recorded.
  - (xiii) The final elapsed time was recorded.

- (xiv) The sampled filter was removed carefully and folded in half length so that only surfaces with collected particulate matter were in contact.
  - (xv) It was then placed in a clean plastic envelope and sealed.
  - (xvi) All monitoring information was recorded on a standard data sheet.
  - (xvii) Filters were then sent to ALS Technichem (HK) Pty Ltd. for analysis.
- (d) Maintenance and Calibration
- (i) The HVS and its accessories were maintained in good working condition, such as replacing motor brushes routinely and checking electrical wiring to ensure a continuous power supply.
  - (ii) 5-point calibration of the HVS was conducted using TE-5025A Calibration Kit prior to the commencement of baseline monitoring. Bi-monthly 5-point calibration of the HVS will be carried out during impact monitoring.
  - (iii) Calibration certificate of the HVSs are provided in Appendix E.

## 2.5.2 1-hour TSP Monitoring

### (a) Measuring Procedures

The measuring procedures of the 1-hour dust meter were in accordance with the Manufacturer's Instruction Manual as follows:

- (i) Turn the power on.
- (ii) Close the air collecting opening cover.
- (iii) Push the "TIME SETTING" switch to [BG].
- (iv) Push "START/STOP" switch to perform background measurement for 6 seconds.
- (v) Turn the knob at SENSI ADJ position to insert the light scattering plate.
- (vi) Leave the equipment for 1 minute upon "SPAN CHECK" is indicated in the display.
- (vii) Push "START/STOP" switch to perform automatic sensitivity adjustment. This measurement takes 1 minute.
- (viii) Pull out the knob and return it to MEASURE position.
- (ix) Push the "TIME SETTING" switch the time set in the display to 3 hours.
- (x) Lower down the air collection opening cover.
- (xi) Push "START/STOP" switch to start measurement.

### (b) Maintenance and Calibration

- (i) The 1-hour TSP meter was calibrated at 1-year intervals against a continuous particulate TEOM Monitor, Series 1400ab. Calibration certificates of the Laser Dust Monitors are provided in Appendix E.
- (ii) 1-hour validation checking of the TSP meter against HVS is carried out yearly at the air quality monitoring locations.

## 2.6 Monitoring Schedule for the Reporting period

2.6.1 The schedule for environmental monitoring in August 2020 is provided in Appendix F.



## 2.7 Results and Observations

2.7.1 The monitoring results for 1-hour TSP and 24-hour TSP are summarized in Table 2.4 and 2.5 respectively. Detailed impact air quality monitoring results are presented in Appendix G.

**Table 2.4 Summary of 1-hour TSP Monitoring Results in the Reporting Period**

| Location  | Average ( $\mu\text{g}/\text{m}^3$ ) | Range ( $\mu\text{g}/\text{m}^3$ ) | Action Level ( $\mu\text{g}/\text{m}^3$ ) | Limit Level ( $\mu\text{g}/\text{m}^3$ ) |
|---|--------------------------------------|------------------------------------|---|--|
| <b>AM2</b><br>(Fanling Government Secondary School) | 61.4                                 | 57.1 – 69.2                        | 317.8                                     | 500                                      |

**Table 2.5 Summary of 24-hour TSP Monitoring Results in the Reporting Period**

| Location  | Average ( $\mu\text{g}/\text{m}^3$ ) | Range ( $\mu\text{g}/\text{m}^3$ ) | Action Level ( $\mu\text{g}/\text{m}^3$ ) | Limit Level ( $\mu\text{g}/\text{m}^3$ ) |
|---|--------------------------------------|------------------------------------|---|--|
| <b>AM2</b><br>(Fanling Government Secondary School) | 18.6                                 | 13.2 – 21.6                        | 200.7                                     | 260                                      |

2.7.2 The major dust source during the monitoring was mainly from nearby traffic emission.

2.7.3 All 1-hour and 24-hour TSP results were below the Action and Limit Level at all monitoring locations in the reporting period.

2.7.4 The event action plan is annexed in Appendix J.

2.7.5 Weather information including wind speed and wind direction is annexed in Appendix H. The information was obtained from the Hong Kong Observatory Tai Po and Tai Mei Tuk Automatic Weather Stations.

### 3 NOISE MONITORING

#### 3.1 Monitoring Requirements

3.1.1 In accordance with the EM&A Manual, impact noise monitoring was conducted for at least once per week during the construction phase of the Contract. The Action and Limit level of the noise monitoring is provided in Appendix D.

#### 3.2 Monitoring Equipment

3.2.1 Noise monitoring was performed using sound level meter at each designated monitoring station. The sound level meters deployed comply with the International Electrotechnical Commission Publications (IEC) 651:1979 (Type 1) and 804:1985 (Type 1) specifications. Acoustic calibrator was deployed to check the sound level meters at a known sound pressure level. Brand and model of the equipment is given in Table 3.1.

**Table 3.1 Noise Monitoring Equipment**

| Equipment                    | Brand and Model   |
|------------------------------|-------------------|
| Integrated Sound Level Meter | B&K 2238 / 2250-L |
| Acoustic Calibrator          | B&K 4231          |

#### 3.3 Monitoring Locations

3.3.1 Monitoring stations M2 and M3 were set up at the proposed locations in accordance with updated EM&A Manual. Figure 1.3a-b shows the locations of the monitoring stations. Table 3.2 describes the details of the monitoring stations.

**Table 3.2 Locations of Impact Noise Monitoring Stations**

| Monitoring Station | Location                            | Description   |
|--------------------|-------------------------------------|---|
| M2                 | West Tai Wo                         | 1.2m from the ground floor free-field of the Residential  |
| M3                 | Fanling Government Secondary School | 1m from the exterior of the roof top façade of the school |

#### 3.4 Monitoring Parameters and Frequency

3.4.1 Table 3.3 summarizes the monitoring parameters, frequency and duration of impact noise monitoring.

**Table 3.3 Noise Monitoring Parameters, Frequency and Duration**

| Parameter  | Frequency              |
|--|------------------------|
| 30-mins measurement at each monitoring station between 0700 and 1900 on normal weekdays. $L_{eq}$ , $L_{10}$ and $L_{90}$ would be recorded. | At least once per week |

### 3.5 Monitoring Methodology

#### 3.5.1 Monitoring Procedure

- (a) Façade measurement was made at monitoring station M3, while free-field measurement was made at monitoring station M2.
- (b) The sound level meter was set on a tripod at a height of 1.2 m above the ground for free-field measurements at monitoring station M2.
- (c) The battery condition was checked to ensure the correct functioning of the meter.
- (d) Parameters such as frequency weighting, the time weighting and the measurement time were set as follows:
  - (i) frequency weighting: A
  - (ii) time weighting: Fast
  - (iii) time measurement:  $L_{eq(30\text{-minutes})}$  during non-restricted hours i.e. 07:00 – 1900 on normal weekdays;  $L_{eq(5\text{-minutes})}$  during restricted hours i.e. 19:00 – 23:00 and 23:00 – 07:00 of normal weekdays, whole day of Sundays and Public Holidays
- (e) Prior to and after each noise measurement, the meter was calibrated using the acoustic calibrator for 94dB(A) at 1000 Hz. If the difference in the calibration level before and after measurement was more than 1 dB(A), the measurement would be considered invalid and repeat of noise measurement would be required after re-calibration or repair of the equipment.
- (f) During the monitoring period, the  $L_{eq}$ ,  $L_{10}$  and  $L_{90}$  were recorded. In addition, site conditions and noise sources were recorded on a standard record sheet.
- (g) Noise measurement was paused during periods of high intrusive noise (e.g. dog barking, helicopter noise) if possible. Observations were recorded when intrusive noise was unavoidable.
- (h) Noise monitoring was cancelled in the presence of fog, rain, wind with a steady speed exceeding 5m/s, or wind with gusts exceeding 10m/s.

#### 3.5.2 Maintenance and Calibration

- (a) The microphone head of the sound level meter was cleaned with soft cloth at regular intervals.
- (b) The meter and calibrator were sent to the supplier or HOKLAS laboratory to check and calibrate at yearly intervals.
- (c) Calibration certificates of the sound level meters and acoustic calibrators are provided in Appendix E.

### 3.6 Monitoring Schedule for the Reporting period

- 3.6.1 The schedule for environmental monitoring in August 2020 is provided in Appendix F.

### 3.7 Monitoring Results

3.7.1 The monitoring results for construction noise are summarized in Table 3.4 and the monitoring data is provided in Appendix I.

**Table 3.4 Summary of Construction Noise Monitoring Results in the Reporting Period**

| <b>Location</b>  | <b>Average, dB(A),<br/><math>L_{eq}</math> (30 mins)</b> | <b>Range, dB(A),<br/><math>L_{eq}</math> (30 mins)</b> | <b>Limit Level, dB(A),<br/><math>L_{eq}</math> (30 mins)</b> |
|--|--|--|--|
| <b>M2*</b><br>(West Tai Wo)                            | 66.2   | 65.5 – 66.7  | 75   |
| <b>M3#</b><br>(Fanling Government<br>Secondary School) | 62.1   | 60.6 – 63.2  | 65/70  |

\*+3dB(A) Façade correction included

# Limit Level of 70dB(A) applies to education institutes while 65dB(A) applies during school examination period.

3.7.2 No Action or Limit Level exceedance of construction noise was recorded in the reporting month. No noise complaints related to 0700 – 1900 hours on normal weekdays was received and followed by Environmental Team in the reporting month.

3.7.3 Major noise sources during noise monitoring in the reporting period were mainly road traffic noise.

3.7.4 The event action plan is annexed in Appendix J.

## 4 ENVIRONMENTAL SITE INSPECTION AND AUDIT

### 4.1 Site Inspection

4.1.1 Site Inspections were carried out on a weekly basis to monitor the implementation of proper environmental pollution control and mitigation measures for the Contract. In the reporting period, 4 site inspections were carried out respectively on 4, 11, 18 and 25 August 2020 for the Contract. While no specific observation was recorded, recommendations on remedial actions were given to the Contractor for precautionary purpose.

4.1.2 The environmental site inspections summaries are provided in Appendix K.

4.1.3 Particular observations during the site inspections are described below:

Contract No. HY/2012/06

#### ***Air Quality***

4.1.4 Stockpile placed without cover was observed at SA324 and SA340. The Contractor was advised to cover the stockpile with imperious sheeting for dust suppression.

4.1.5 Breaking work carried without dust control measure was observed at SA340. The Contractor was advised to provide watering to the dusty work.

4.1.6 The Contractor was reminded to clean silt at outside boundary of SA340.

4.1.7 The Contractor was reminded to provide water spraying at exposed area of SA340 regularly.

4.1.8 The Contractor was reminded to affix the NRMM label on the bulldozer at SA340.

#### ***Noise***

4.1.9 No adverse observation was identified in the reporting period.

#### ***Water Quality***

4.1.10 No adverse observation was identified in the reporting period.

#### ***Chemical and Waste Management***

4.1.11 Improper disposal of general refuse and construction waste was observed at SA340. The Contractor was advised to provide sufficient waste collection point and store the waste properly. The Contractor was also advised to provide onsite waste sorting for the general refuse, construction waste and recyclable material.

#### ***Landscape and Visual Impact***

4.1.12 No adverse observation was identified in the reporting period.

#### ***Miscellaneous***

4.1.13 No adverse observation was identified in the reporting period.

## 4.2 Advice on the Solid and Liquid Waste Management Status

- 4.2.1 Contract No. HY/2012/06 has registered as chemical waste producers for the Contract. C&D material sorting was carried out on site. Sufficient numbers of receptacles were available for general refuse collection.
- 4.2.2 As advised by the Contractor of Contract No. HY/2012/06, 2,011 m<sup>3</sup> of inert C&D material was generated in the reporting month (1,182 m<sup>3</sup> disposed of as public fill to Tuen Mun 38, 503 m<sup>3</sup> of inert C&D materials was reused on site, 264 m<sup>3</sup> of inert C&D materials was reused in other projects and 62 m<sup>3</sup> was broken concrete). For C&D wastes, 75 m<sup>3</sup> of general refuse was disposed of at NENT landfill, 135 kg of paper/cardboard packaging, 0 kg of plastics and 0 kg of metals were collected by recycling Contractors, and 0 kg of chemical wastes was collected by licensed Contractors in the reporting period.
- 4.2.3 The actual amounts of different types of waste generated by the activities of the Project in the reporting period are shown in Table 4.1.

**Table 4.1 Summary of Waste Flow Table for Contract No. HY/2012/06**

| Waste Type                                  | Actual Amount        | Disposal/Reuse Locations |
|---|----------------------|--------------------------|
| Inert C&D materials disposed as public fill | 1,182 m <sup>3</sup> | Tuen Mun 38              |
| Broken concrete                             | 62 m <sup>3</sup>    | Tuen Mun 38              |
| C&D wastes disposed as general refuse       | 75 m <sup>3</sup>    | NENT Landfill            |
| Paper/cardboard packaging                   | 0 kg                 | Recycling Facilities     |
| Plastics                                    | 0 kg                 | Recycling Facilities     |
| Metals                                      | 0 kg                 | Recycling Facilities     |
| C&D materials reused on site                | 503 m <sup>3</sup>   | Site Area                |
| C&D materials reused in other projects      | 264 m <sup>3</sup>   | Other projects           |
| Chemical wastes                             | 0 kg                 | Licensed Contractors     |

- 4.2.4 The Contractors were advised to maintain on-site waste sorting and recording system and maximize reuse / recycle of C&D wastes.

### 4.3 Environmental Licenses and Permits

4.3.1 The environmental licenses and permits for Stage 2 of the Project and valid in the reporting period is summarized in Table 4.2.

**Table 4.2 Summary of Environmental Licensing and Permit Status**

| Statutory Reference | License/ Permit   | License or Permit No. | Valid Period |            | License / Permit Holder | Remarks  |
|---------------------|---|-----------------------|--------------|------------|-------------------------|--|
|                     |   |                       | From         | To         |                         |  |
| EIAO                | Environment al Permit   | EP-324/2008/E         | 26/01/2017   | N/A        | HyD                     |  |
| WPCO                | Discharge License (Site)  | WT-00031556-2018      | 20/09/2018   | 30/09/2023 | CSHK                    | --   |
|                     |   | WT00027968-2017       | 22/05/2017   | 31/05/2022 | Chiu Hing               | --   |
| WDO                 | Chemical Waste Producer Registration                                    | 5213-722-C3822-01     | 05/09/2013   | N/A        | CSHK                    | Chemical waste produced in Contract HY/2012/06               |
| WDO                 | Billing Account for Disposal of Construction Waste                      | 7017860               | N/A          | N/A        | CSHK                    | Waste disposal in Contract HY/2012/06                        |
|                     |   | 7024392               | N/A          | N/A        | Chiu Hing               | Waste disposal in Contract 02/HY/2015                        |
| APCO                | Notification Under Air Pollution Control (Construction Dust) Regulation | 361991                | 15/07/2013   | N/A        | CSHK                    | --   |
|                     |   | 414360                | 08/03/2017   | N/A        | Chiu Hing               | --   |
| NCO                 | Construction Noise Permit   | GW-RN0373-20          | 11/06/2020   | 19/08/2020 | CSHK                    | Zone 4 Laying of Cross Road Duct                             |
|                     |   | GW-RN0432-20          | 25/06/2020   | 03/09/2020 | CSHK                    | Zone 4 Sign Gantry Modification                              |
|                     |   | GW-RN0481-20          | 09/07/2020   | 25/08/2020 | CSHK                    | Zone 4 U-Channel Construction & Profile barriers Replacement |
|                     |   | GW-RN0483-20          | 09/07/2020   | 19/08/2020 | CSHK                    | Zone 1 Road Resurfacing                                      |
|                     |   | GW-RN0491-20          | 09/07/2020   | 31/08/2020 | CSHK                    | Zone 4 Installation of Directional Sign                      |

| Statutory Reference | License/ Permit | License or Permit No. | Valid Period |            | License / Permit Holder | Remarks  |
|---------------------|-----------------|-----------------------|--------------|------------|-------------------------|--|
|                     |                 |                       | From         | To         |                         |  |
|                     |                 | GW-RN0489-20          | 19/07/2020   | 22/09/2020 | CSHK                    | Zone 4 Road Resurfacing                        |
|                     |                 | GW-RN0537-20          | 27/07/2020   | 31/08/2020 | CSHK                    | Southbound of Fanling Highway Road Resurfacing |
|                     |                 | GW-RN0543-20          | 30/07/2020   | 31/08/2020 | CSHK                    | CH21.2 and CH22.5 Road Resurfacing             |
|                     |                 | GW-RN0572-20          | 10/08/2020   | 31/08/2020 | CSHK                    | Zone 4 Construction of Detector Loop           |
|                     |                 | GW-RN0574-20          | 09/08/2020   | 31/08/2020 | CSHK                    | Zone 4 Road Resurfacing                        |
|                     |                 | GW-RN0575-20          | 09/08/2020   | 31/08/2020 | CSHK                    | Zone 4 Laying of Cross Road Duct               |

#### 4.4 Implementation Status of Environmental Mitigation Measures

4.4.1 A summary of the Implementation Schedule of Environmental Mitigation Measures (EMIS) is presented in Appendix C.

#### 4.5 Summary of Exceedances of the Environmental Quality Performance Limit

4.5.1 All 1-hour and 24-hour TSP monitoring results complied with the Action / Limit Levels in the reporting period.

4.5.2 No Action or Limit Level exceedance of construction noise was recorded in the reporting month. No noise complaints related to 0700 – 1900 hours on normal weekdays was received and followed by Environmental Team in the reporting month.

#### 4.6 Summary of Complaints, Notification of Summons and Successful Prosecutions

4.6.1 The Environmental Complaint Handling Procedure is annexed in Figure 4.1.

4.6.2 No complaint, notification of summons and successful prosecution was received in the reporting period.

4.6.3 Statistics on complaints, notifications of summons and successful prosecutions are summarized in Appendix L.



## **5 FUTURE KEY ISSUES**

### **5.1 Construction Programme for the Coming Months**

5.1.1 The major construction works for Contract No. HY/2012/06 in September 2020 will be:

- Site clearance;
- Excavation;
- Backfilling;
- Road resurfacing;
- Landscape works.

### **5.2 Key Issues for the Coming Month**

5.2.1 Key issues to be considered in September 2020:

- Properly store and label oils and chemicals on site;
- Chemical, chemical waste and waste management;
- Collection of construction waste should be carried out regularly;
- Properly maintain all drainage facilities and wheel washing facilities on site;
- Exposed slopes should be covered up properly if no temporary work will be conducted;
- Quieter powered mechanical equipment should be used;
- Suppress dust generated from excavation activities and haul road traffic; and
- Tree protective measures for all retained trees should be well maintained.

### **5.3 Monitoring Schedule for the Coming Month**

5.3.1 The tentative schedule for environmental monitoring in September 2020 is provided in Appendix F.

## 6 CONCLUSIONS AND RECOMMENDATIONS

### 6.1 Conclusions

- 6.1.1 The construction phase and EM&A programme of the Contract commenced on 21 November 2013.
- 6.1.2 All 1-hour and 24-hour TSP monitoring results complied with the Action / Limit Levels in the reporting period.
- 6.1.3 No Action or Limit Level exceedance of construction noise was recorded in the reporting month. No noise complaints related to 0700 – 1900 hours on normal weekdays was received and followed by Environmental Team in the reporting month.
- 6.1.4 4 environmental site inspections were carried out in August 2020. Recommendations on remedial actions were given to the Contractors for the deficiencies identified during the site audits.
- 6.1.5 No complaint, notification of summons and successful prosecution was received in the reporting period.

### 6.2 Recommendations

- 6.2.1 According to the environmental site inspections performed in the reporting period, the following recommendations on remedial actions were provided to the Contractor for precautionary purpose:

Contract No. HY/2012/06

#### ***Air Quality***

- 6.2.2 The Contractor was advised to cover the stockpile with imperious sheeting for dust suppression.
- 6.2.3 The Contractor was advised to provide watering to the dusty work.
- 6.2.4 The Contractor was reminded to clean silt at outside boundary.
- 6.2.5 The Contractor was reminded to provide water spraying at exposed area regularly.
- 6.2.6 The Contractor was reminded to affix the NRMM label on the bulldozer.

#### ***Noise***

- 6.2.7 No adverse observation was identified in the reporting period.

#### ***Water Quality***

- 6.2.8 No adverse observation was identified in the reporting period.

#### ***Chemical and Waste Management***

- 6.2.9 The Contractor was advised to provide sufficient waste collection point and store the waste properly. The Contractor was also advised to provide onsite waste sorting for the general refuse, construction waste and recyclable material.

#### ***Landscape and Visual Impact***

- 6.2.10 No adverse observation was identified in the reporting period.

#### ***Miscellaneous***

- 6.2.11 No adverse observation was identified in the reporting period.

---

---

## FIGURES

---

---

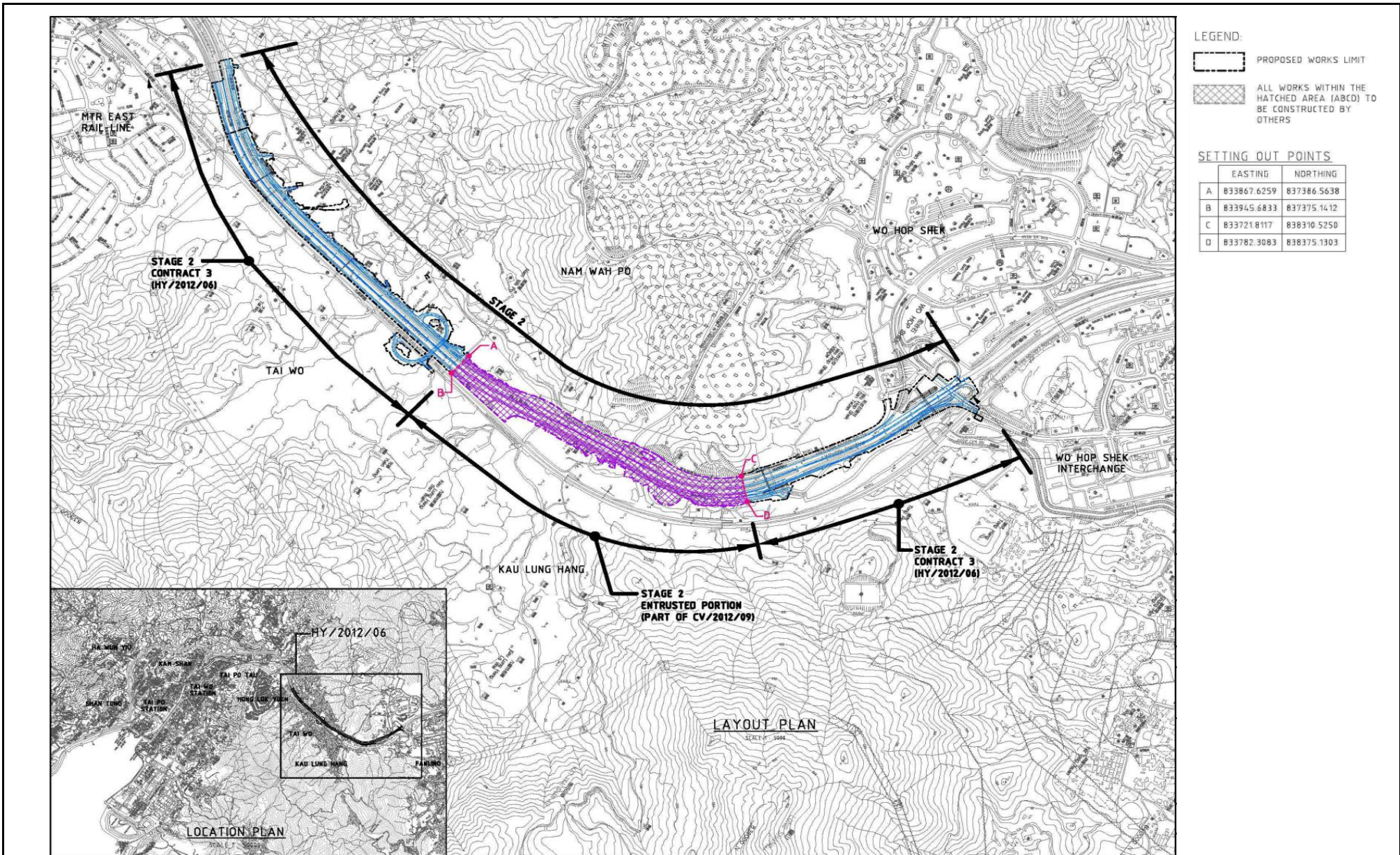

This Drawing has been prepared for the use of AECOM's client. It may not be used, modified, reproduced or relied upon by third parties, except as agreed by AECOM or as required by law. AECOM accepts no responsibility, and denies any liability whatsoever, to any party that uses or relies on this drawing without AECOM's express written consent.

CONTRACT NO. HY/2012/06  
 WIDENING OF FANLING HIGHWAY  
 - TAI HANG TO WO HOP SHEK INTERCHANGE



Layout Plan

Date: Dec 2013

Figure 1.1



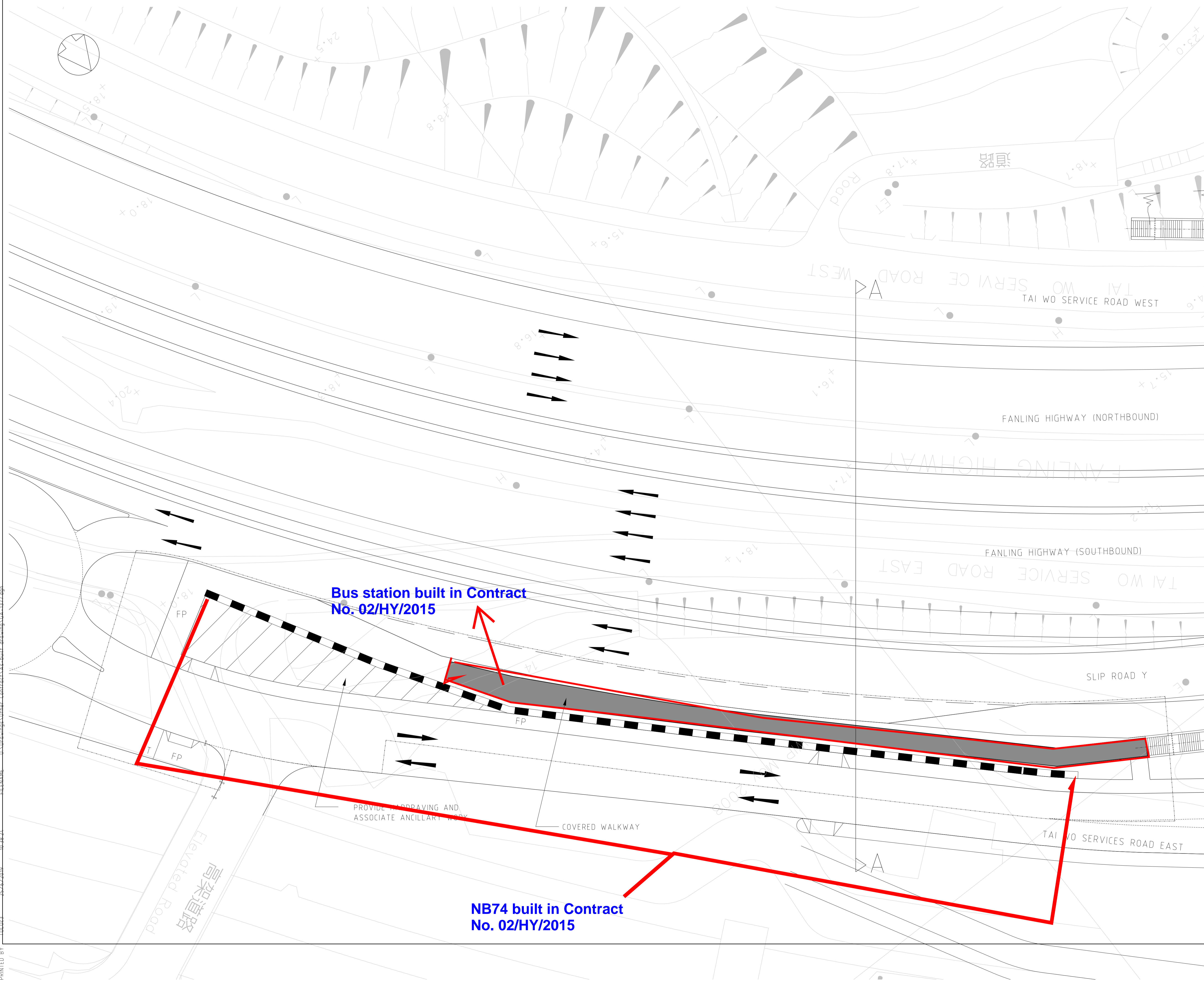

- LEGENDS :**
- LIMIT OF WORKS AREA
  - VERTICAL NOISE BARRIER 6m HIGH
  - COVERED WALKWAY
  - FOOTPATH
  - CYCLE TRACK

| Z                  | OCT2018   | AS-BUILT DRAWING                                     | EC      | JP  |
|--------------------|-----------|--|---------|-----|
| REV                | DATE      | DESCRIPTION  | CHECKED | APP |
| 修訂                 | 日期        | 內容摘要   | 覆核      | 批覆人 |
| REVISION           |           |  |         |     |
| DESIGNED           | RL        | CHECKED  | EC      |     |
| 繪圖                 | YKN       | 覆核   | -       |     |
| APPROVED FOR ISSUE | JP        | © Copyright Reserved                                 |         |     |
| 批覆人                | JP        | 版權所 有  |         |     |
| DATE               | JUL. 2017 | All dimensions are in mm unless shown otherwise      |         |     |
| 日期                 | JUL. 2017 | No measurement should be taken from drawing directly |         |     |
| SCALE              | AS SHOWN  |  |         |     |
| 比例                 | AS SHOWN  |  |         |     |
| CAD REF            | A1 = 1250 |  |         |     |
| 檔案名稱               | A3 = 1300 |  |         |     |

路政署  
**HIGHWAYS DEPARTMENT**  
 主要工程管理處  
 MAJOR WORKS PROJECT MANAGEMENT OFFICE

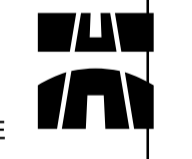

CONTRACT TITLE  
 合約項目  
**Highways Department Term Contract (Management and Maintenance of Roads in Tai Po and North Districts excluding High Speed Roads 2016-2012)**

CONTRACT NO 02/HY/2015

CONSULTANT  
 工程顧問  
**Hyder ARUP BLACK & VEATCH**

DRAWING TITLE  
 圖名  
**GENERAL LAYOUT FOR BBI**

AS-BUILT DRAWING

DRAWING NO  
 圖紙編號  
 02/HY/2015/1377

REV  
 修訂  
 Z

**Bus station built in Contract No. 02/HY/2015**

**NB74 built in Contract No. 02/HY/2015**

PROVIDE PAVING AND ASSOCIATE ANCILLARY WORK  
 COVERED WALKWAY

PRINTED BY TLOLO-3 25/4/2018 10:38:27 FILENAME: D:\Drawings\Other\_Contract\As-built\_drawing\_G4\_1377.dwg

100mm ON ORIGINAL



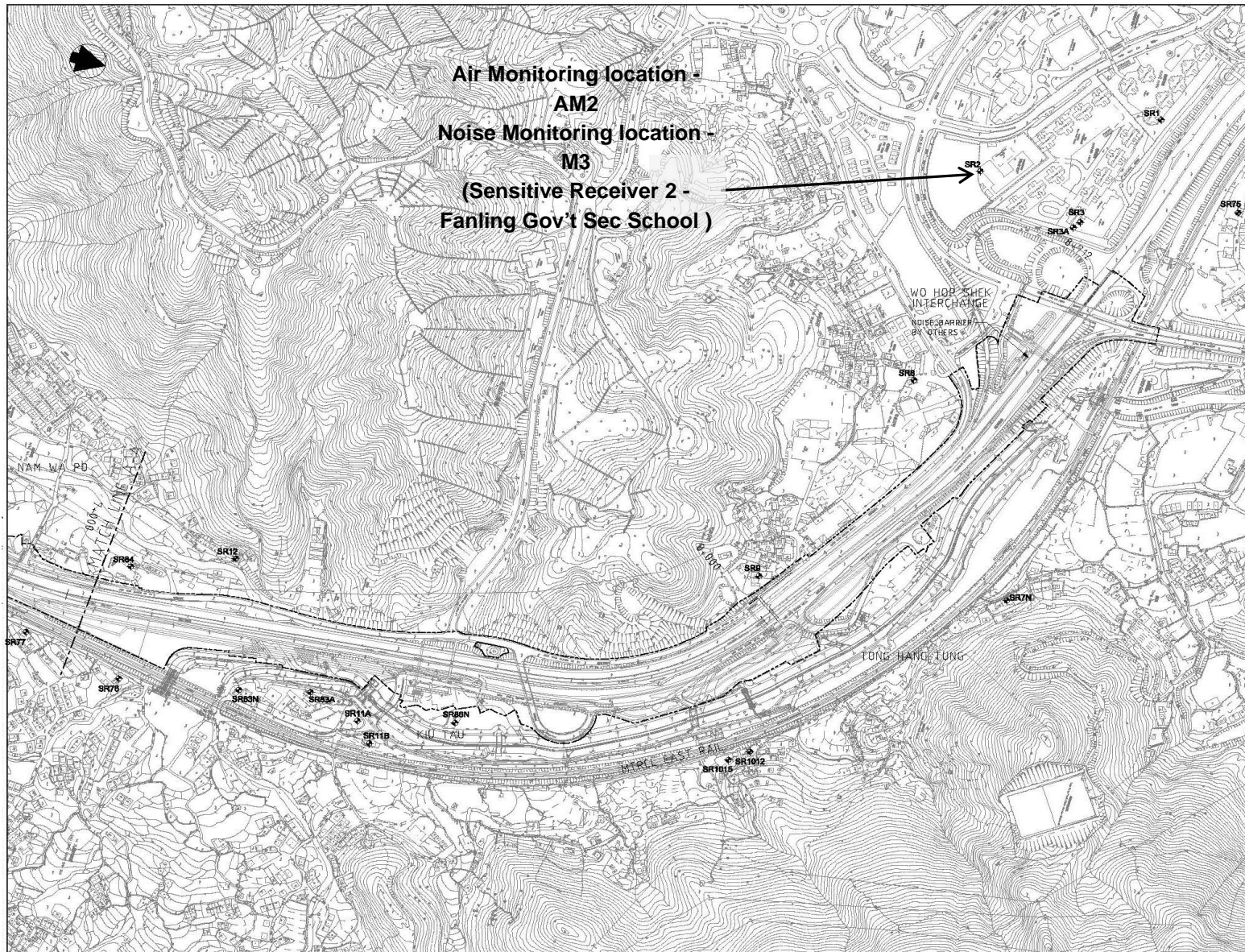

This Drawing has been prepared for the use of AECOM's client. It may not be used, modified, reproduced or relied upon by third parties, except as agreed by AECOM or as required by law. AECOM accepts no responsibility, and denies any liability whatsoever, to any party that uses or relies on this drawing without AECOM's express written consent.

CONTRACT NO. HY/2012/06  
 WIDENING OF FANLING HIGHWAY  
 - TAI HANG TO WO HOP SHEK INTERCHANGE



Locations of Monitoring Station

Date: Dec 2013

Figure 1.3a

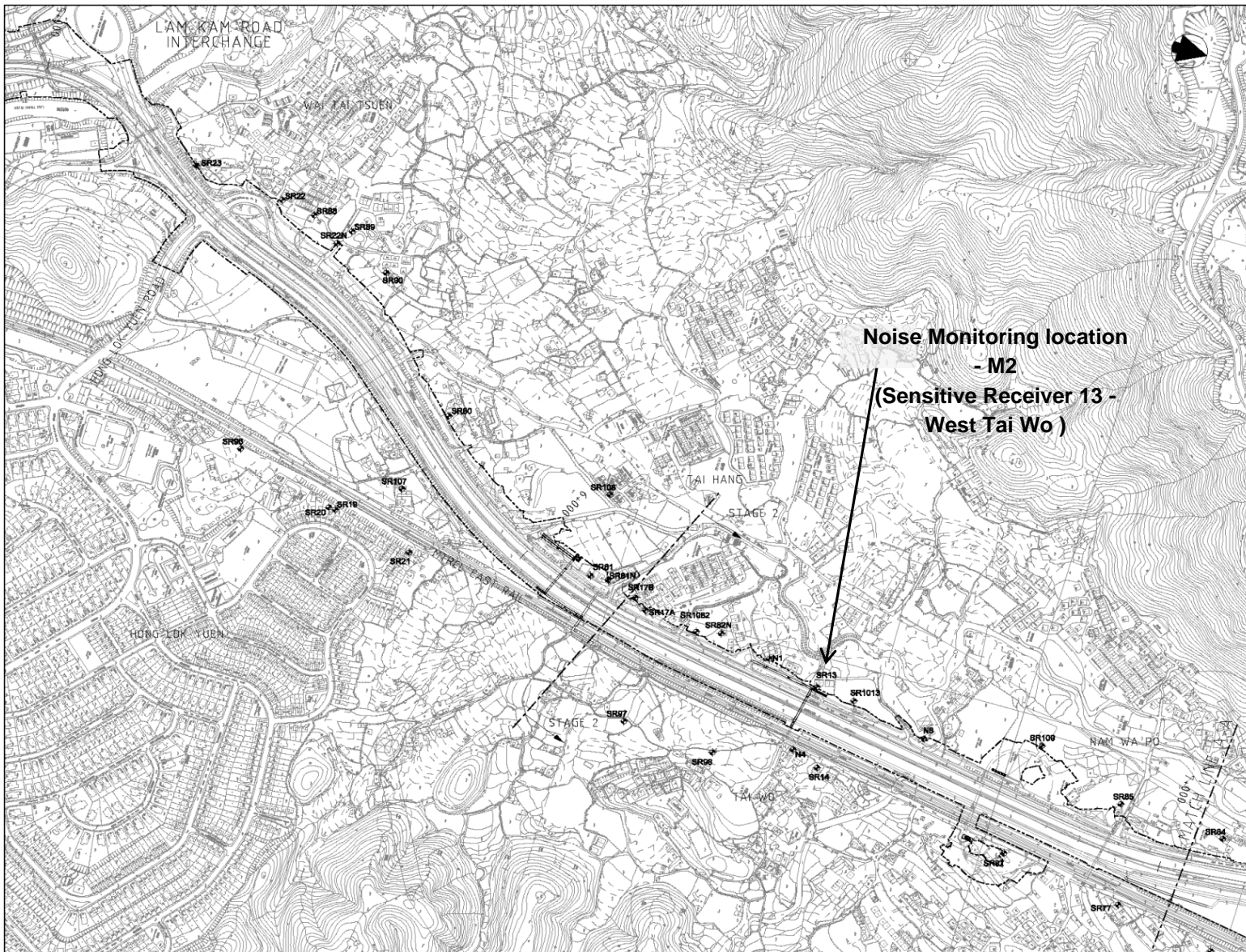

This Drawing has been prepared for the use of AECOM's client. It may not be used, modified, reproduced or relied upon by third parties, except as agreed by AECOM or as required by law. AECOM accepts no responsibility, and denies any liability whatsoever, to any party that uses or relies on this drawing without AECOM's express written consent.

CONTRACT NO. HY/2012/06  
 WIDENING OF FANLING HIGHWAY  
 - TAI HANG TO WO HOP SHEK INTERCHANGE



Locations of Monitoring Station

Date: Dec 2013

Figure 1.3b

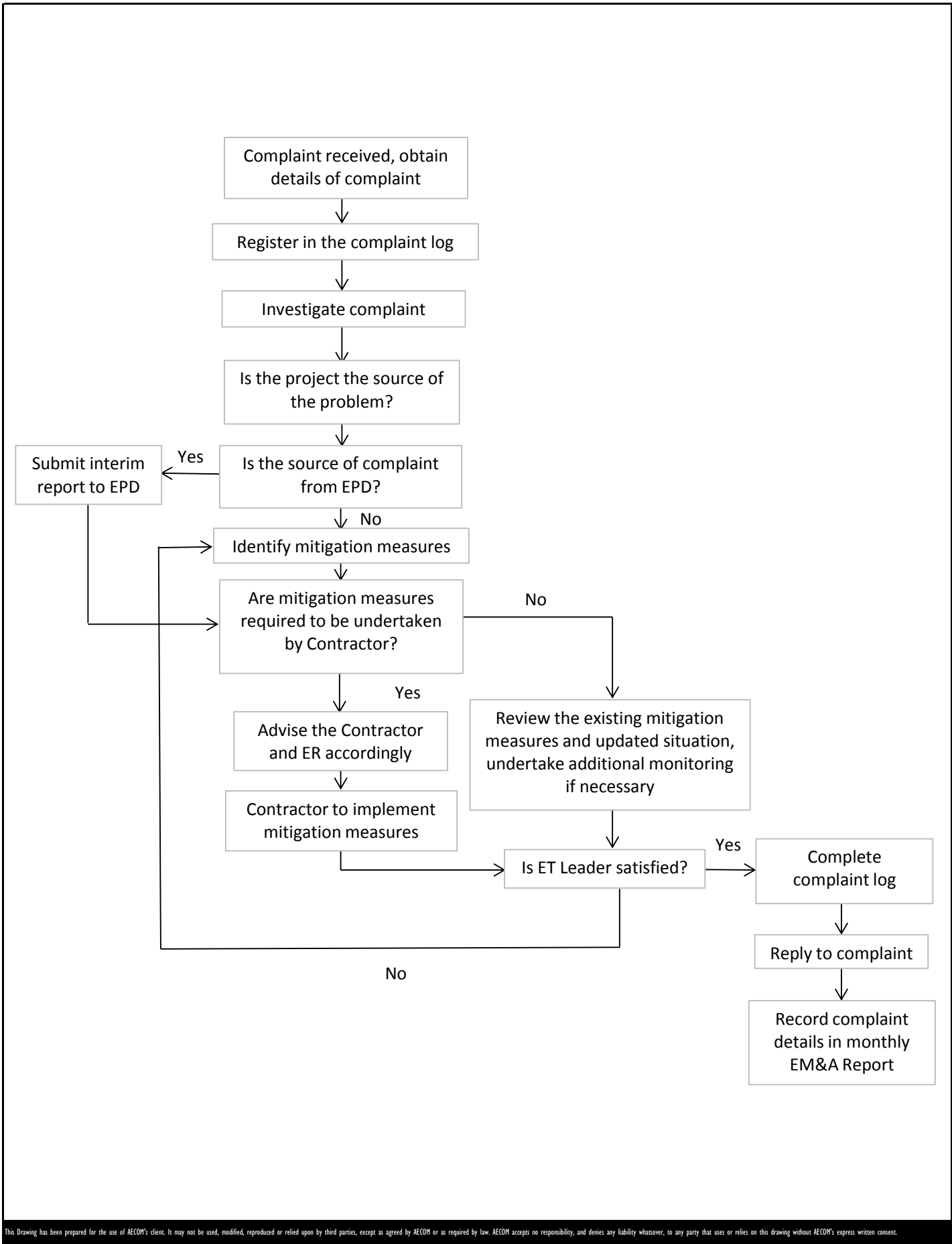

This Drawing has been prepared for the use of AECOM's client. It may not be used, modified, reproduced or relied upon by third parties, except as agreed by AECOM or as required by law. AECOM accepts no responsibility, and denies any liability whatsoever, to any party that uses or relies on this drawing without AECOM's express written consent.

CONTRACT NO. HY/2012/06  
 WIDENING OF FANLING HIGHWAY  
 - TAI HANG TO WO HOP SHEK INTERCHANGE



Environmental Complaint Handling Procedure



---

---

**APPENDIX A  
PROJECT ORGANIZATION STRUCTURE**

---

---

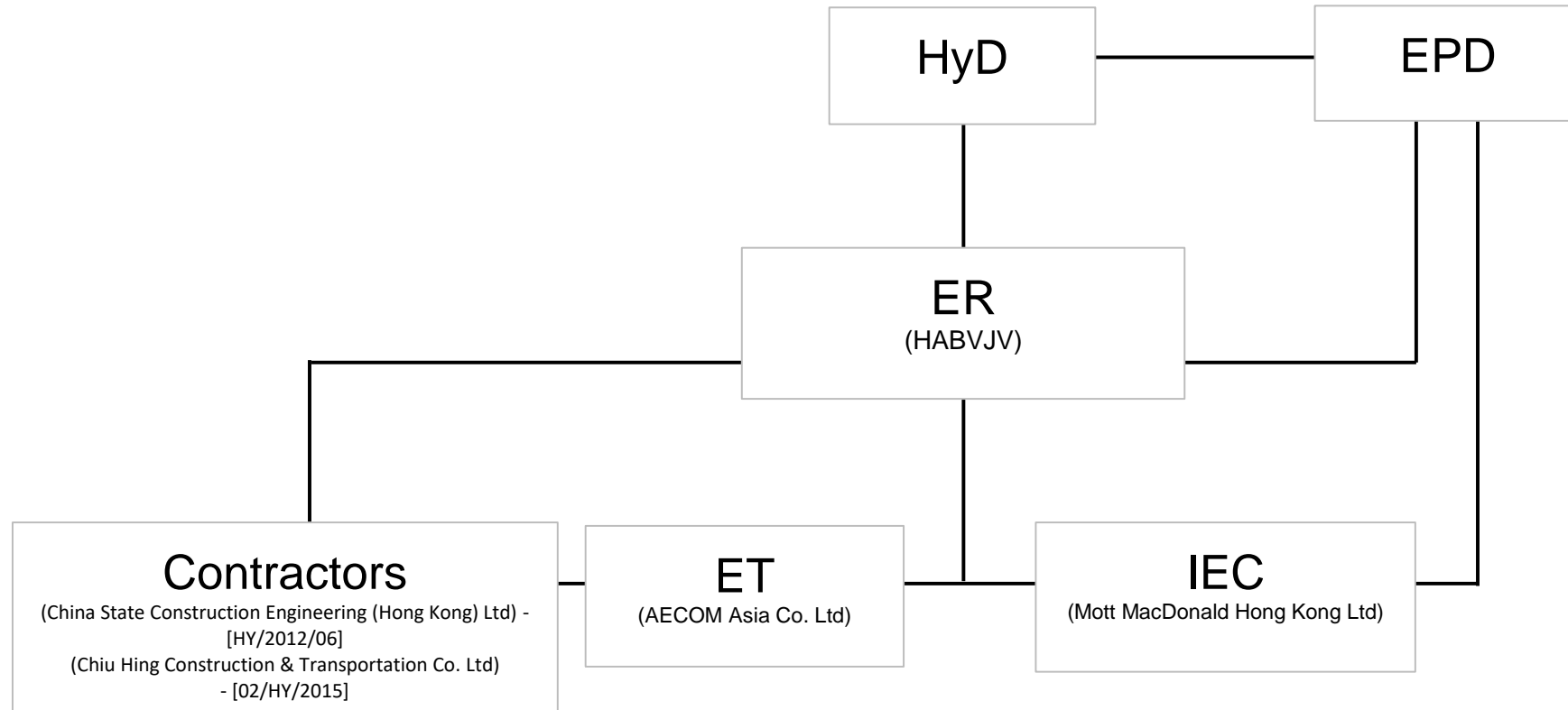

This Drawing has been prepared for the use of AECOM's client. It may not be used, modified, reproduced or relied upon by third parties, except as agreed by AECOM or as required by law. AECOM accepts no responsibility, and denies any liability whatsoever, to any party that uses or relies on this drawing without AECOM's express written consent.

CONTRACT NO. HY/2012/06  
 WIDENING OF FANLING HIGHWAY  
 - TAI HANG TO WO HOP SHEK INTERCHANGE



Project Organization Structure

---

---

**APPENDIX B  
CONSTRUCTION PROGRAMMES**

---

---

| Activity ID   | Activity Name  | Dur. % Complete | Rem. Duration | Original Duration | Start       | Finish    | Total Float | 2019 |     | 2020 |   |
|---|--|-----------------|---------------|-------------------|-------------|-----------|-------------|------|-----|------|---|
|   |  |                 |               |                   |             |           |             | Nov  | Dec | Jan  | Feb   |
| <b>ZONE 1 (Ch. 5640 to 5880)</b>                      |  |                 |               |                   |             |           |             |      |     |      |   |
| <b>Other Works</b>                                    |  |                 |               |                   |             |           |             |      |     |      |   |
| VO189 - Irrigation System in Zone 1 and Zone 2        |  |                 |               |                   |             |           |             |      |     |      |   |
| <b>VO189 - Irrigation System in Zone 1 and Zone 2</b> |  |                 |               |                   |             |           |             |      |     |      |   |
| IS0120  | Irrigation system installation in Zone 1                                     | 0%              | 30            | 30                | 20-Nov-19*  | 24-Dec-19 | 252         |      |     |      |   |
| <b>Establishment Works</b>                            |  |                 |               |                   |             |           |             |      |     |      |   |
| <b>Establishment Works</b>                            |  |                 |               |                   |             |           |             |      |     |      |   |
| Z1.EW.1000  | Establishment work Zone1   | 44.38%          | 203           | 365               | 11-Jun-19 A | 09-Jun-20 | 0           |      |     |      |   |
| <b>ZONE 2 (Ch. 5880 to 6930)</b>                      |  |                 |               |                   |             |           |             |      |     |      |   |
| <b>General</b>  |  |                 |               |                   |             |           |             |      |     |      |   |
| DRM Proposal  |  |                 |               |                   |             |           |             |      |     |      |   |
| <b>DRM Proposal</b>                                   |  |                 |               |                   |             |           |             |      |     |      |   |
| ADVZ20300   | TWSR-W lane 2 construction   | 0%              | 30            | 30                | 27-Dec-19   | 03-Feb-20 | 222         |      |     |      |   |
| <b>Noise Barrier Along Fanling Highway N/B</b>        |  |                 |               |                   |             |           |             |      |     |      |   |
| NB43A (Ch.5880-6060)-FH N/B Side                      |  |                 |               |                   |             |           |             |      |     |      |   |
| <b>Noise Barrier Works</b>                            |  |                 |               |                   |             |           |             |      |     |      |   |
| NB03340   | Relocate Bus Shelter installation - VO86                                     | 0%              | 11            | 11                | 16-Dec-19*  | 30-Dec-19 | 249         |      |     |      |   |
| <b>Underground Utility Works</b>                      |  |                 |               |                   |             |           |             |      |     |      |   |
| <b>Underground Utility Works</b>                      |  |                 |               |                   |             |           |             |      |     |      |   |
| UU0110  | Towgas duct laying and associated work before backfill in Zone 1 & 2         | 92.72%          | 41            | 563               | 20-Apr-18A  | 30-Dec-19 | 187         |      |     |      |   |
| UU0130  | TTA duct laying and Road reinstatement by Towgas in Zone 1 & 2 (if required) | 0%              | 120           | 120               | 31-Dec-19   | 28-Apr-20 | 187         |      |     |      |   |
| <b>Bridge Construction</b>                            |  |                 |               |                   |             |           |             |      |     |      |   |
| <b>New Tai Hang Footbridge</b>                        |  |                 |               |                   |             |           |             |      |     |      |   |
| <b>General</b>  |  |                 |               |                   |             |           |             |      |     |      |   |
| THBF0655  | Tai Hang Footbridge Complete   | 0%              | 0             | 0                 |             | 31-Dec-19 | 248         |      |     |      | 31-Dec-19 ◆ Tai Hang Footbridge Complete    |
| <b>TWSR-East FL Highway S/B Side Section</b>          |  |                 |               |                   |             |           |             |      |     |      |   |
| THBF0640  | Finishes Work  | 0%              | 34            | 30                | 25-Sep-19 A | 31-Dec-19 | 248         |      |     |      |   |
| THBF0645  | Bridge Structure complete (THFB-TWSR-E side)                                 | 0%              | 0             | 0                 |             | 31-Dec-19 | 248         |      |     |      | 31-Dec-19 ◆ Bridge Structure complete (THFB |
| THBF0800  | ABWF work  | 0%              | 34            | 30                | 25-Sep-19 A | 31-Dec-19 | 248         |      |     |      |   |
| <b>Lift at TWSR-W Side</b>                            |  |                 |               |                   |             |           |             |      |     |      |   |
| L1800   | THFB Completion Date   | 0%              | 0             | 0                 |             | 31-Dec-19 | 248         |      |     |      | 31-Dec-19 ◆ THFB Completion Date            |
| <b>Lift at FLHY S/B</b>                               |  |                 |               |                   |             |           |             |      |     |      |   |
| L1400   | Roof cover for RC Platform   | 0%              | 33            | 30                | 25-Sep-19 A | 30-Dec-19 | 249         |      |     |      |   |
| L1430   | EMSD inspection & approval   | 60.71%          | 11            | 28                | 21-Oct-19A  | 30-Nov-19 | 292         |      |     |      |   |
| L1440   | E&M and Finishes work  | 0%              | 35            | 35                | 02-Dec-19   | 14-Jan-20 | 237         |      |     |      |   |
| L1460   | Lift available - NF78  | 0%              | 0             | 0                 |             | 14-Jan-20 | 237         |      |     |      | 14-Jan-20 ◆ Lift available - NF78           |
| L1490   | THFB Completion Date   | 0%              | 0             | 0                 |             | 31-Dec-19 | 248         |      |     |      | 31-Dec-19 ◆ THFB Completion Date            |
| <b>New Tai Wo Footbridge</b>                          |  |                 |               |                   |             |           |             |      |     |      |   |
| <b>General</b>  |  |                 |               |                   |             |           |             |      |     |      |   |
| TWFB1110  | Tai Wo Footbridge Complete   | 0%              | 0             | 0                 |             | 30-Dec-19 | 235         |      |     |      | 30-Dec-19 ◆ Tai Wo Footbridge Complete      |
| <b>Crossing Fanling Highway Section</b>               |  |                 |               |                   |             |           |             |      |     |      |   |
| TWFB1460  | Finishes Work  | 80.36%          | 33            | 168               | 06-Apr-19A  | 30-Dec-19 | 235         |      |     |      |   |
| TWFB1470  | Bridge Structure complete (TWFB-Cross fanling highway)                       | 0%              | 0             | 0                 |             | 30-Dec-19 | 235         |      |     |      | 30-Dec-19 ◆ Bridge Structure complete (TWFB |
| <b>Lift at TWSR-W Side</b>                            |  |                 |               |                   |             |           |             |      |     |      |   |
| L1760   | EMSD inspection & approval   | 71.43%          | 8             | 28                | 31-Oct-19A  | 27-Nov-19 | 322         |      |     |      |   |
| L1770   | E&M and Finishes work  | 93.33%          | 10            | 150               | 23-Apr-19A  | 30-Nov-19 | 258         |      |     |      |   |
| L1790   | Lift available - NF116-Lift 1  | 0%              | 0             | 0                 |             | 30-Nov-19 | 258         |      |     |      | 30-Nov-19 ◆ Lift available - NF116-Lift 1   |
| L1810   | New Tai Wo footbridge completion   | 0%              | 0             | 0                 |             | 30-Dec-19 | 249         |      |     |      | 30-Dec-19 ◆ New Tai Wo footbridge completor |
| <b>Signalized Junction</b>                            |  |                 |               |                   |             |           |             |      |     |      |   |
| <b>New Tai Hang Footbridge</b>                        |  |                 |               |                   |             |           |             |      |     |      |   |
| <b>TWSR-West/ FL Highway N/B Side Section</b>         |  |                 |               |                   |             |           |             |      |     |      |   |
| THBF0630  | Installation of Traffic Signal Poles at TWSR-W N/B (Tai hang Junction)       | 0%              | 21            | 21                | 18-Jan-20   | 13-Feb-20 | 192         |      |     |      |   |
| THBF0650  | Ducting & Cable Draw Installation (Tai hang Junction)                        | 79.39%          | 27            | 131               | 08-May-19 A | 20-Dec-19 | 192         |      |     |      |   |
| THBF0660  | Installation of Traffic Signal Poles at TWSR-W S/B (Tai hang Junction)       | 0%              | 21            | 21                | 21-Dec-19   | 17-Jan-20 | 192         |      |     |      |   |
| THBF0670  | E-prom ordering by EMSD (Tai hang Junction)                                  | 82.93%          | 56            | 328               | 20-Nov-18 A | 14-Jan-20 | 302         |      |     |      |   |
| THBF0680  | Ducting & cable draw inspection by EMSD (Tai hang Junction)                  | 0%              | 6             | 6                 | 15-Jan-20   | 21-Jan-20 | 213         |      |     |      |   |
| THBF0690  | Ducting & cable draw rectification (Tai hang Junction)                       | 0%              | 12            | 12                | 22-Jan-20   | 06-Feb-20 | 213         |      |     |      |   |
| THBF0692  | PCCW cable installation & connection (Tai hang Junction)                     | 0%              | 6             | 6                 | 14-Feb-20   | 20-Feb-20 | 207         |      |     |      |   |
| THBF0694  | EMSD cable & equipment installation (Tai hang Junction)                      | 0%              | 21            | 21                | 14-Feb-20   | 09-Mar-20 | 192         |      |     |      |   |
| <b>TWSR-West Construction</b>                         |  |                 |               |                   |             |           |             |      |     |      |   |
| <b>Drainage &amp; Road Works</b>                      |  |                 |               |                   |             |           |             |      |     |      |   |
| <b>Ch 5880-6740</b>                                   |  |                 |               |                   |             |           |             |      |     |      |   |

|  |  |   |  |           |           |        |
|--|--|---|--|-----------|-----------|--------|
|  | Project ID: WP Rev 08 (1911)<br>Layout: 3 Month Rolling Program<br>Page 1 of 3 | <b>Contract No. HY/2012/06</b><br><b>Widening of Fanling Highway - Tai Hang to Wo Hop Shek Interchange</b><br><b>3 Month Rolling Program(20-Nov-19)</b> |  | Date      | Revision  | C/A... |
|  |  |   |  | 17-Aug-17 | WP Rev 5  |        |
|  |  |   |  | 28-Mar-18 | WP Rev 6  |        |
|  |  |   |  | 27-Nov-18 | WP Rev 6A |        |
|  |  |   |  | 15-Jan-19 | WP Rev 7  |        |
|  |  |   |  | 31-Oct-19 | WP Rev 8  |        |

| WP Rev. 8 (Progress Update)(20-Nov-19)                               |   | 3 Month Rolling Program |               |                   |             |           |             | Page 2 of 3 (22-Nov-19) |     |           |  |
|--|---|-------------------------|---------------|-------------------|-------------|-----------|-------------|-------------------------|-----|-----------|--|
| Activity ID  | Activity Name   | Dur. % Complete         | Rem. Duration | Original Duration | Start       | Finish    | Total Float | 2019                    |     | 2020      |  |
|  |   |                         |               |                   |             |           |             | Nov                     | Dec | Jan       | Feb  |
| RDZ20140   | Z2 (CH5880-6930) : New TWSR - West Road works (2 lanes) complete  | 0%                      | 0             | 0                 |             | 03-Feb-20 | 222         |                         |     | 03-Feb-20 | ◆ Z2 (CH5880-6930) : New TWSR - West Road works (2 lanes) complete |
| RDZ20170   | Z2 : New TWSR-Westroad Works (lane 2)                             | 0%                      | 30            | 30                | 27-Dec-19   | 03-Feb-20 | 222         |                         |     |           |  |
| <b>Other Works</b>   |   |                         |               |                   |             |           |             |                         |     |           |  |
| <b>TCSS Works</b>  |   |                         |               |                   |             |           |             |                         |     |           |  |
| <b>Civil Provision for TCSS Works</b>                                |   |                         |               |                   |             |           |             |                         |     |           |  |
| TCSS2140   | M10 for CCTV  | 0%                      | 14            | 14                | 31-Dec-19   | 16-Jan-20 | 235         |                         |     |           |  |
| TCSS2180   | Pillar box, isolator & associated duct work - PL204 for G30 & G55 | 0%                      | 16            | 16                | 20-Nov-19   | 07-Dec-19 | 266         |                         |     |           |  |
| TCSS2190   | Pillar box, isolator & associated duct work - PL205 for G54 & M10 | 0%                      | 16            | 16                | 20-Nov-19   | 07-Dec-19 | 266         |                         |     |           |  |
| TCSS2200   | Pillar box, isolator & associated duct work - PL206 for G32       | 0%                      | 16            | 16                | 20-Nov-19   | 07-Dec-19 | 266         |                         |     |           |  |
| TCSS2270   | Civil Provision for TCSS works available (Zone 2)                 | 0%                      | 0             | 0                 |             | 07-Dec-19 | 266         |                         |     |           | ◆ Civil Provision for TCSS works available (Zone 2)                |
| <b>VO184 - Irrigation System in SA328 and SA329</b>                  |   |                         |               |                   |             |           |             |                         |     |           |  |
| <b>VO184 - Irrigation System in SA328 and SA329</b>                  |   |                         |               |                   |             |           |             |                         |     |           |  |
| IS0140   | Irrigation system installation in SA328 and SA329                 | 34.69%                  | 32            | 49                | 04-Sep-19 A | 28-Dec-19 | 250         |                         |     |           |  |
| <b>VO189 - Irrigation System in Zone 1 and Zone 2</b>                |   |                         |               |                   |             |           |             |                         |     |           |  |
| <b>VO189 - Irrigation System in Zone 1 and Zone 2</b>                |   |                         |               |                   |             |           |             |                         |     |           |  |
| IS0130   | Irrigation system installation in Zone 2                          | 4.08%                   | 47            | 49                | 04-Sep-19 A | 16-Jan-20 | 235         |                         |     |           |  |
| <b>Landscape Softwork</b>  |   |                         |               |                   |             |           |             |                         |     |           |  |
| <b>Landscape Works</b>   |   |                         |               |                   |             |           |             |                         |     |           |  |
| Z2.LW.1000   | Landscape soft work Zone2   | 0%                      | 47            | 32                | 25-Sep-19 A | 16-Jan-20 | 235         |                         |     |           |  |
| <b>Establishment Works</b>   |   |                         |               |                   |             |           |             |                         |     |           |  |
| <b>Establishment Works</b>   |   |                         |               |                   |             |           |             |                         |     |           |  |
| Z2.EW.1000   | Establishment work Zone2  | 4.66%                   | 348           | 365               | 02-Nov-19 A | 01-Nov-20 | 0           |                         |     |           |  |
| <b>Pai Lau in Tai Hang (VO126)</b>                                   |   |                         |               |                   |             |           |             |                         |     |           |  |
| <b>Pai Lau in Tai Hang (VO126)</b>                                   |   |                         |               |                   |             |           |             |                         |     |           |  |
| <b>Pai Lau in Tai Hang (VO126)</b>                                   |   |                         |               |                   |             |           |             |                         |     |           |  |
| PL01050  | Pai Lau Superstructure  | 84.62%                  | 10            | 65                | 07-Oct-19 A | 30-Nov-19 | 231         |                         |     |           |  |
| PL01080  | Material Order & delivery on site                                 | 0%                      | 45            | 45                | 20-Nov-19   | 14-Jan-20 | 196         |                         |     |           |  |
| PL01090  | Finishes works  | 0%                      | 41            | 41                | 15-Jan-20   | 04-Mar-20 | 196         |                         |     |           |  |
| <b>South Buffer Zone 1 (SBZ1) (within Zone 2)(Ch.6740 to 6930)</b>   |   |                         |               |                   |             |           |             |                         |     |           |  |
| <b>Bridge Construction</b>   |   |                         |               |                   |             |           |             |                         |     |           |  |
| <b>Kau Lung Hang Vehicular Bridge</b>                                |   |                         |               |                   |             |           |             |                         |     |           |  |
| <b>KLH Bridge - West Ramp</b>  |   |                         |               |                   |             |           |             |                         |     |           |  |
| KLH.1290   | West Ramp - Planting  | 0%                      | 34            | 34                | 20-Nov-19*  | 31-Dec-19 | 248         |                         |     |           |  |
| <b>KLH Bridge - Deck 1</b>   |   |                         |               |                   |             |           |             |                         |     |           |  |
| KLH.3430   | Deck 1 - Planting   | 0%                      | 34            | 34                | 20-Nov-19   | 31-Dec-19 | 248         |                         |     |           |  |
| <b>KLH Bridge - Deck 3</b>   |   |                         |               |                   |             |           |             |                         |     |           |  |
| KLH.3500   | Deck 3 - Planting   | 0%                      | 34            | 34                | 20-Nov-19   | 31-Dec-19 | 248         |                         |     |           |  |
| <b>KLH Bridge - East Ramp</b>  |   |                         |               |                   |             |           |             |                         |     |           |  |
| KLH.3590   | East Ramp - Planting  | 0%                      | 34            | 34                | 20-Nov-19   | 31-Dec-19 | 248         |                         |     |           |  |
| <b>KLH Bridge - Staircase S1</b>                                     |   |                         |               |                   |             |           |             |                         |     |           |  |
| Z2.KLH.1500  | S1 - Roof steel frame installation                                | 75.61%                  | 10            | 41                | 11-Sep-19 A | 30-Nov-19 | 242         |                         |     |           |  |
| Z2.KLH.1750  | S1 - Corrugated steel roof  | 0%                      | 18            | 18                | 02-Dec-19   | 21-Dec-19 | 242         |                         |     |           |  |
| Z2.KLH.1760  | S1 - Handrail   | 0%                      | 12            | 12                | 23-Dec-19   | 08-Jan-20 | 242         |                         |     |           |  |
| Z2.KLH.1770  | S1 - Lighting & finishes works                                    | 0%                      | 12            | 12                | 23-Dec-19   | 08-Jan-20 | 242         |                         |     |           |  |
| <b>Bridge Road Work</b>  |   |                         |               |                   |             |           |             |                         |     |           |  |
| Z2.KLH.2040  | Landscape work of KLHVB   | 71.95%                  | 46            | 164               | 23-Apr-19 A | 15-Jan-20 | 236         |                         |     |           |  |
| <b>Signalized Junction</b>   |   |                         |               |                   |             |           |             |                         |     |           |  |
| <b>Kau Lung Hang Vehicular Bridge</b>                                |   |                         |               |                   |             |           |             |                         |     |           |  |
| <b>KLH Bridge - West Ramp</b>  |   |                         |               |                   |             |           |             |                         |     |           |  |
| Z2.KLH.1032  | Installation of Traffic Signal Poles at TWSR-W N/B (KLHVB)        | 0%                      | 34            | 21                | 14-Nov-19 A | 31-Dec-19 | 227         |                         |     |           |  |
| Z2.KLH.1082  | Ducting & cable draw rectification (KLHVB)                        | 0%                      | 22            | 12                | 19-Oct-19 A | 14-Dec-19 | 248         |                         |     |           |  |
| Z2.KLH.1092  | PCCW cable installation & connection (KLHVB)                      | 0%                      | 6             | 6                 | 02-Jan-20   | 08-Jan-20 | 236         |                         |     |           |  |
| Z2.KLH.1102  | EMSD cable & equipment installation (KLHVB)                       | 0%                      | 21            | 21                | 02-Jan-20   | 28-Jan-20 | 227         |                         |     |           |  |
| Z2.KLH.1112  | Traffic Signal Installation complete (KLHVB)                      | 0%                      | 0             | 0                 |             | 28-Jan-20 | 227         |                         |     |           | ◆ Traffic Signal   |
| <b>North Buffer Zone 2 (NBZ2) (within Zone 4) (Ch. 7925 to 8100)</b> |   |                         |               |                   |             |           |             |                         |     |           |  |
| <b>Bridge Construction</b>   |   |                         |               |                   |             |           |             |                         |     |           |  |
| <b>New Ho Ka Yuen Footbridge</b>                                     |   |                         |               |                   |             |           |             |                         |     |           |  |
| <b>TWSR-West/ FL Highway N/B Side Section</b>                        |   |                         |               |                   |             |           |             |                         |     |           |  |
| HKY1520  | VO11 - slope improvement work                                     | 0%                      | 45            | 45                | 20-Nov-19   | 14-Jan-20 | 237         |                         |     |           |  |
| <b>ZONE 4 (Ch. 7925 to 8700)</b>                                     |   |                         |               |                   |             |           |             |                         |     |           |  |
| <b>Bridge Construction</b>   |   |                         |               |                   |             |           |             |                         |     |           |  |
| <b>New Wo Hop Shek Pedestrian &amp; Cycle Bridge</b>                 |   |                         |               |                   |             |           |             |                         |     |           |  |
| <b>General</b>   |   |                         |               |                   |             |           |             |                         |     |           |  |
| WHS1110  | Wo Hop Shek Bridge Complete                                       | 0%                      | 0             | 0                 |             | 31-Dec-19 | 248         |                         |     |           | ◆ Wo Hop Shek Bridge Complete                                      |
| <b>TWSR-West/ FL Highway N/B Side Section</b>                        |   |                         |               |                   |             |           |             |                         |     |           |  |
| WHS1420  | Ramp Finishes Work  | 91.37%                  | 34            | 394               | 13-Jul-18 A | 31-Dec-19 | 248         |                         |     |           |  |
| WHS1430  | Bridge Structure complete (WHS-TWSR-W side)                       | 0%                      | 0             | 0                 |             | 31-Dec-19 | 248         |                         |     |           | ◆ Bridge Structure complete (WHS-TWSR-W side)                      |

| Activity ID   | Activity Name   | Dur. % Complete | Rem. Duration | Original Duration | Start       | Finish    | Total Float | 2019 |  |     |  | 2020 |  |     |
|---|---|-----------------|---------------|-------------------|-------------|-----------|-------------|------|--|-----|--|------|--|-----|
|   |   |                 |               |                   |             |           |             | Nov  |  | Dec |  | Jan  |  | Feb |
|   |   |                 |               |                   |             |           |             |      |  |     |  |      |  |     |
| <b>VO152 - Additional Retaining Wall in Zone 4 Near at Grade Cycle Track and Footpath at WHS Bridge</b> |   |                 |               |                   |             |           |             |      |  |     |  |      |  |     |
| <b>Cycle Track</b>  |   |                 |               |                   |             |           |             |      |  |     |  |      |  |     |
| WHS1560   | Retaining Wall construction   | 0%              | 34            | 24                | 14-Nov-19 A | 31-Dec-19 | 101         |      |  |     |  |      |  |     |
| WHS1570   | Concrete Footing for railing  | 0%              | 10            | 10                | 02-Jan-20   | 13-Jan-20 | 101         |      |  |     |  |      |  |     |
| WHS1580   | Concrete Footing for Expressway boundary fence                                  | 0%              | 10            | 10                | 14-Jan-20   | 24-Jan-20 | 101         |      |  |     |  |      |  |     |
| WHS1590   | 300 U-channel   | 0%              | 12            | 12                | 28-Jan-20   | 10-Feb-20 | 149         |      |  |     |  |      |  |     |
| WHS1600   | backfill  | 0%              | 3             | 3                 | 11-Feb-20   | 13-Feb-20 | 149         |      |  |     |  |      |  |     |
| WHS1610   | Cycle Track sub-base & wearing course   | 0%              | 6             | 6                 | 14-Feb-20   | 20-Feb-20 | 149         |      |  |     |  |      |  |     |
| <b>Footpath</b>   |   |                 |               |                   |             |           |             |      |  |     |  |      |  |     |
| WHS2150   | Concrete Footing for railing  | 0%              | 15            | 15                | 28-Jan-20   | 13-Feb-20 | 101         |      |  |     |  |      |  |     |
| WHS2160   | Concrete Footing for Expressway boundary fence                                  | 0%              | 15            | 15                | 14-Feb-20   | 02-Mar-20 | 101         |      |  |     |  |      |  |     |
| <b>TWSR-West Construction</b>   |   |                 |               |                   |             |           |             |      |  |     |  |      |  |     |
| <b>Drainage &amp; Road Works</b>  |   |                 |               |                   |             |           |             |      |  |     |  |      |  |     |
| <b>TWSR-West/ FL Highway NB Side Section</b>  |   |                 |               |                   |             |           |             |      |  |     |  |      |  |     |
| RDZ41180  | TWSR -W Road Works rectification  | 0%              | 18            | 18                | 20-Nov-19   | 10-Dec-19 | 264         |      |  |     |  |      |  |     |
| <b>Other Works</b>  |   |                 |               |                   |             |           |             |      |  |     |  |      |  |     |
| <b>TCSS Works</b>   |   |                 |               |                   |             |           |             |      |  |     |  |      |  |     |
| <b>TCSS Pre-Construction Works</b>  |   |                 |               |                   |             |           |             |      |  |     |  |      |  |     |
| TCSS0180  | Sign Gantry Factory production - FVMS1 (Deleted)                                | 0%              | 0             | 0                 | 20-Nov-19   | 20-Nov-19 | 282         |      |  |     |  |      |  |     |
| <b>Civil Provision for TCSS Works</b>   |   |                 |               |                   |             |           |             |      |  |     |  |      |  |     |
| TCSS2150  | M12 for CCTV  | 0%              | 14            | 14                | 02-Jan-20*  | 17-Jan-20 | 234         |      |  |     |  |      |  |     |
| TCSS2160  | P51 for VSLS  | 0%              | 14            | 14                | 02-Dec-19*  | 17-Dec-19 | 168         |      |  |     |  |      |  |     |
| TCSS2170  | P52 for VSLS  | 0%              | 14            | 14                | 02-Dec-19*  | 17-Dec-19 | 168         |      |  |     |  |      |  |     |
| TCSS2210  | Pillar box, isolator & associated duct work - PL207 for G34 & G35               | 0%              | 30            | 30                | 18-Dec-19*  | 24-Jan-20 | 168         |      |  |     |  |      |  |     |
| TCSS2230  | Pillar box, isolator & associated duct work - PL251 for G51                     | 0%              | 30            | 30                | 28-Jan-20   | 02-Mar-20 | 168         |      |  |     |  |      |  |     |
| <b>DS50</b>   |   |                 |               |                   |             |           |             |      |  |     |  |      |  |     |
| TCSS1850  | Sign Gantry Erection - DS50 (Z4) (Deleted by Verbal instruction, VO is pending) | 0%              | 0             | 0                 | 20-Nov-19   | 20-Nov-19 | 282         |      |  |     |  |      |  |     |
| <b>TCSS Hub Room</b>  |   |                 |               |                   |             |           |             |      |  |     |  |      |  |     |
| TCSS1920  | TCSS Hub Room BS provision  | 24.44%          | 34            | 45                | 29-Oct-19A  | 31-Dec-19 | 248         |      |  |     |  |      |  |     |
| <b>VO190 - Irrigation System near Ho Ka Yuen Footbridge</b>   |   |                 |               |                   |             |           |             |      |  |     |  |      |  |     |
| <b>VO190 - Irrigation System near Ho Ka Yuen Footbridge</b>   |   |                 |               |                   |             |           |             |      |  |     |  |      |  |     |
| IS160   | Irrigation system installation near Ho Ka Yuen Footbridge                       | 73.91%          | 6             | 23                | 04-Sep-19 A | 26-Nov-19 | 276         |      |  |     |  |      |  |     |
| <b>Landscape Softwork</b>   |   |                 |               |                   |             |           |             |      |  |     |  |      |  |     |
| <b>Landscape Works</b>  |   |                 |               |                   |             |           |             |      |  |     |  |      |  |     |
| Z4.LW.1000  | Landscape soft work Zone4   | 73.91%          | 6             | 23                | 04-Sep-19 A | 26-Nov-19 | 276         |      |  |     |  |      |  |     |
| <b>Establishment Works</b>  |   |                 |               |                   |             |           |             |      |  |     |  |      |  |     |
| <b>Establishment Works</b>  |   |                 |               |                   |             |           |             |      |  |     |  |      |  |     |
| Z3.EW.1000  | Establishment work Zone4  | 13.15%          | 317           | 365               | 02-Oct-19A  | 01-Oct-20 | 0           |      |  |     |  |      |  |     |
| <b>VO Relocation of Traffic Sign at Pak Wo Road &amp; Jockey Club Road</b>                              |   |                 |               |                   |             |           |             |      |  |     |  |      |  |     |
| <b>VO Relocation of Traffic Sign at Pak Wo Road &amp; Jockey Club Road</b>                              |   |                 |               |                   |             |           |             |      |  |     |  |      |  |     |
| TS01030   | TTA submission & approval   | 0%              | 40            | 34                | 02-Sep-19 A | 08-Jan-20 | 125         |      |  |     |  |      |  |     |
| TS01040   | TTA   | 0%              | 2             | 2                 | 09-Jan-20   | 10-Jan-20 | 125         |      |  |     |  |      |  |     |
| TS01050   | Sheet piling & excavation   | 0%              | 18            | 18                | 11-Jan-20   | 03-Feb-20 | 125         |      |  |     |  |      |  |     |
| TS01060   | Footing (FL02,ADS52)  | 0%              | 45            | 45                | 04-Feb-20   | 26-Mar-20 | 125         |      |  |     |  |      |  |     |
| TS1160  | XP application period - Jockey Club Road  | 62.04%          | 41            | 108               | 08-Aug-19 A | 30-Dec-19 | 164         |      |  |     |  |      |  |     |
| TS1180  | TTA   | 0%              | 2             | 2                 | 31-Dec-19   | 02-Jan-20 | 132         |      |  |     |  |      |  |     |
| TS1190  | Sheet piling & excavation   | 0%              | 18            | 18                | 03-Jan-20   | 23-Jan-20 | 132         |      |  |     |  |      |  |     |
| TS1200  | Footing (DS53, FL01)  | 0%              | 45            | 45                | 24-Jan-20   | 18-Mar-20 | 132         |      |  |     |  |      |  |     |
| <b>Ducting Works in Traffic Signalized Junction at Pak Wo Road</b>                                      |   |                 |               |                   |             |           |             |      |  |     |  |      |  |     |
| <b>WHS Interchange</b>  |   |                 |               |                   |             |           |             |      |  |     |  |      |  |     |
| TSJ01050  | Duct Laying (Road Crossing) - Pak Wo Road                                       | 8.7%            | 42            | 46                | 17-Sep-19 A | 10-Jan-20 | 240         |      |  |     |  |      |  |     |
| <b>Pak Wo Road and Jockey Club Road Junction</b>  |   |                 |               |                   |             |           |             |      |  |     |  |      |  |     |
| TSJ01260  | Existing MJ modified by HyD structure   | 34.43%          | 40            | 61                | 26-Oct-19A  | 08-Jan-20 | 101         |      |  |     |  |      |  |     |
| TSJ01270  | Road Construction & reinstatement (new 2nd stage after MJ modification by HyD)  | 0%              | 35            | 35                | 09-Jan-20   | 20-Feb-20 | 101         |      |  |     |  |      |  |     |
| <b>Commissioning of Traffic Signalized Junction (by EMSD)</b>   |   |                 |               |                   |             |           |             |      |  |     |  |      |  |     |
| TSJ01220  | Eprom procurement   | 0%              | 60            | 60                | 13-Dec-19   | 26-Feb-20 | 101         |      |  |     |  |      |  |     |

---

---

**APPENDIX C  
IMPLEMENTATION SCHEDULE OF  
ENVIRONMENTAL MITIGATION MEASURES  
(EMIS)**

---

---

**Appendix C - Implementation Schedule of Environmental Mitigation Measures (EMIS)**

**Air Quality – Schedule of Recommended Mitigation Measures**

| Impact                          | Mitigation Measures   | Timing              | Implementation Status |
|---------------------------------|---|---------------------|-----------------------|
| Air Quality during construction | Restricting heights from which materials are dropped, as far as practicable to minimize the fugitive dust arising from unloading/loading.   | During construction | V                     |
|                                 | All stockpiles of excavated materials or spoil of more than 50m <sup>3</sup> shall be enclosed, covered or dampened during dry or windy conditions.                                     |                     | @                     |
|                                 | Effective water sprays shall be used to control potential dust emission sources such as unpaved haul roads and active construction areas.   |                     | @                     |
|                                 | All spraying of materials and surfaces shall avoid excessive water usage.   |                     | V                     |
|                                 | Vehicles that have the potential to create dust while transporting materials shall be covered, with the cover properly secured and extended over the edges of the side and tail boards. |                     | V                     |
|                                 | Materials shall be dampened, if necessary, before transportation.   |                     | V                     |
|                                 | Travelling speeds shall be controlled to reduce traffic induced dust dispersion and re-suspension within the site from the operating haul trucks.                                       |                     | V                     |
|                                 | Vehicle washing facilities shall be provided to minimize the quantity of material deposited on public roads.  |                     | @                     |



### Noise – Schedule of Recommended Mitigation Measures

| Impact                    | Mitigation Measures   | Timing  | Implementation Status |
|---------------------------|---|---|-----------------------|
| Noise during construction | Use of silenced plant or plant equipped with mufflers or dampers in substitute of ordinary plant.   | During construction   | V                     |
|                           | Reduce the number of equipment and their percentage on-time.  |   | V                     |
|                           | 3.5 m and 5.5 m high temporary noise barrier at culvert construction work area (Figure 2a of the Environmental Permit).                   |   | V*                    |
|                           | 3 m high temporary noise barrier along the northern edge of Bridge 12 at ground level (Figure 2b of the Environmental Permit).            |   | V*                    |
|                           | 2 m high temporary noise barrier along the northern edge of Bridge 12 at bridge level (Figure 2b of the Environmental Permit).            |   | V*                    |
|                           | 2.5 m high temporary noise barrier along Tai Wo Service Road West (Figure 2c of the Environmental Permit).                                |   | V*                    |
|                           | 3.5m and 7m high temporary noise barrier along Tai Wo Services Road West near Tai Hang (Figure 2c of the Environmental Permit).           |   | V*                    |
|                           | 7 m high temporary noise barrier along Tai Wo Service Road West near Tai Wo Footbridge work area (Figure 2d of the Environmental Permit). |   | V*                    |
|                           | 7 m high temporary noise barrier near Kiu Tau Footbridge work area (Figure 2d of the Environmental Permit).                               |   | V*                    |
|                           | 2.5 m high temporary noise barrier near river diversion work area (Figure 2e of the Environmental Permit).                                |   | V*                    |
| Noise during operation    | Various type of barriers of varying heights as shown in Figures 4a to 4e – Layout of Noise Barriers of the Environmental Permit           | Review of required noise barrier layout during the design stage | V*                    |

\* Permanent noise barriers have been erected.

### Water Quality – Schedule of Recommended Mitigation Measures

| Impact                            | Mitigation Measures   | Timing              | Implementation Status |
|-----------------------------------|---|---------------------|-----------------------|
| Water quality during construction | Demolition and reconstruction of bridges <ul style="list-style-type: none"> <li>- Prevent off-site migration through use of sheet piles.</li> <li>- Minimise duration of works as far as practical.</li> <li>- All sewer and drainage connections should be sealed to prevent debris, soil, sand, etc, from entering public sewers/drains.</li> <li>- Site surface runoff should be settled to remove sand/silt before it is discharged into the existing storm drains.</li> </ul>  | During construction | V                     |
|                                   | Road Widening Works, Earthworks and Culvert Extension Works <ul style="list-style-type: none"> <li>- Wastewater generated from any concrete batching washdown of equipment or similar activities should be discharged into foul sewers, after the removal of settleable solids, and pH adjustment as necessary. All sewage discharges from the study area should meet the TM standards and approval from EPD through the licensing process is required.</li> <li>- Sand traps, oil interceptors and other pollution prevention installations should be provided, properly cleaned and maintained.</li> <li>- Runoff from exposed working areas, unfinished slopes and from unlined temporary channels should be directed to stilling basins and/or silt traps before discharging to the drainage outfalls.</li> <li>- Regular inspections of stilling basins and/or silt traps are required to ensure that sediment is not conveyed into the existing drainage system.</li> <li>- Open stockpiles should be covered with a tarpaulin cover.</li> <li>- During the wet season, any exposed top soils should be covered with a tarpaulin, shotcreted or hydroseeded.</li> <li>- Sand and silt from wash-water from vehicle washing should be settled out before discharging into storm drains.</li> <li>- Fuels should be stored in bunded areas such that spillage can be easily collected.</li> </ul> |                     | V                     |

**Waste – Schedule of Recommended Mitigation Measures**

| Impact                               | Mitigation Measures   | Timing              | Implementation Status |
|--------------------------------------|---|---------------------|-----------------------|
| Waste management during construction | <b>General Waste</b><br><ul style="list-style-type: none"> <li>- Transport of wastes off site as soon as possible.</li> <li>- Maintenance of accurate waste records.</li> <li>- Minimisation of waste generation for disposal (via reduction/recycling/re-use).</li> <li>- No on-site burning will be permitted.</li> <li>- Use of re-useable metal hoardings/signboards.</li> </ul>  | During construction | @                     |
|                                      | <b>Vegetation from site clearance</b><br><ul style="list-style-type: none"> <li>- Segregation of materials to facilitate disposal.</li> <li>- Mulching to reduce bulk and where possible review opportunities for the possible beneficial use within landscaping areas.</li> </ul>  |                     | V                     |
|                                      | <b>Demolition Wastes</b><br><ul style="list-style-type: none"> <li>- Segregation of materials to facilitate disposal.</li> <li>- Appropriate stockpile management.</li> </ul>   |                     | V                     |
|                                      | <b>Excavated Materials</b><br><ul style="list-style-type: none"> <li>- Segregation of materials to facilitate disposal / reuse.</li> <li>- Appropriate stockpile management.</li> <li>- Re-use of excavated material on or off site (where possible).</li> <li>- Special handling and disposal procedures in the event that contaminated materials are excavated.</li> </ul>  |                     | V                     |
|                                      | <b>Construction Wastes</b><br><ul style="list-style-type: none"> <li>- Segregation of materials to facilitate recycling/reuse (within designated area in appropriate containers/stockpiles).</li> <li>- Appropriate stockpile management.</li> <li>- Planning to reduce over ordering and waste generation.</li> <li>- Recycling and re-use of materials where possible (e.g. metal, wood from formwork)</li> <li>- For material which cannot be re-used/recycled, collection should be carried out by an approved waste contractor for landfill disposal.</li> </ul> |                     | V                     |
|                                      | <b>Bentonite Slurries</b><br><ul style="list-style-type: none"> <li>- Bentonite slurries should be reused as far as possible.</li> <li>- Disposal in accordance with Practice Note For Professional Persons ProPECC PN 1/94.</li> </ul>   |                     | #                     |

|  |  |  |   |
|--|--|--|---|
|  | <p>Chemical Wastes</p> <ul style="list-style-type: none"> <li>- Storage within locked, covered and bunded area.</li> <li>- The storage area shall not be located adjacent to sensitive receivers e.g. drains.</li> <li>- Minimise waste production and recycle oils/solvents where possible.</li> <li>- A spill response procedure shall be in place and absorption material available for minor spillages.</li> <li>- Use appropriate and labelled containers.</li> <li>- Educate site workers on site cleanliness/waste management procedures.</li> <li>- If chemical wastes are to be generated, the contractor must register with EPD as a chemical waste producer.</li> <li>- The chemical wastes shall be collected by a licensed chemical waste collector.</li> </ul> |  | V |
|  | <p>Municipal Wastes</p> <ul style="list-style-type: none"> <li>- Waste shall be stored within a temporary refuse collection facility, in appropriate containers prior to collection and disposal.</li> <li>- Regular, daily collections are required by an approved waste collector.</li> </ul>  |  | V |

### Ecology – Schedule of Recommended Mitigation Measures

| Impact                      | Mitigation Measures  | Timing              | Implementation Status |
|-----------------------------|--|---------------------|-----------------------|
| Ecology during construction | <p>Accurate Delineation of Works Area</p> <ul style="list-style-type: none"> <li>- Boundaries of proposed works areas shall be clearly identified and separated from external areas by a physical barrier to prevent encroachment of adjacent habitats.</li> <li>- Individual trees which fall within the works areas but which work plans do not require removal are to be retained and fenced off to maximize protection.</li> </ul>   | During construction | V                     |
|                             | <p>Vegetation Clearance</p> <ul style="list-style-type: none"> <li>- No fires shall be lit within the works area for the purpose of burning cleared vegetation.</li> <li>- The Contractor shall give consideration to mulching the cleared vegetation for recycling within the works area / adjacent land.</li> </ul>  |                     | V                     |
|                             | <p>Dust generation</p> <p>There are a number of measures which shall be taken as specified in the Air Pollution Control (Construction Dust) Regulation on 'Dust Control Requirements, including the following key measures to be applied during construction:</p> <ul style="list-style-type: none"> <li>- Vehicle washing facilities to be provided at every discernible or designated vehicle exit point;</li> <li>- All temporary site access roads shall be sprayed with water to suppress dust as necessary;</li> <li>- All dusty materials should be sprayed with water immediately prior to any handling; and</li> <li>- All debris should be covered entirely by impervious sheeting or stored in a sheltered debris collection area.</li> </ul> |                     | V                     |
|                             | <p>Surface Run-off</p> <p>In general, mitigation measures shall be in accordance with ProPECC PN1/94 on 'Construction Site Drainage'. Key measures include:</p> <ul style="list-style-type: none"> <li>- Bund and cover stock piles to avoid run-off;</li> <li>- Channel any run-off through a system of oil, grease and sediment / silt traps and reuse water on site where ever practical;</li> <li>- All vehicle maintenance to be undertaken within a bunded area; and</li> <li>- Maximise vegetation retention on-site to maximise absorption (minimise transport).</li> </ul>  |                     | V                     |

### Landscape and Visual Impact – Schedule of Recommended Mitigation Measures

| Impact                                 | Mitigation Measures  | Timing              | Responsibility |
|--|--|---------------------|----------------|
| Landscape & Visual during construction | <b>Preservation of Existing Vegetation</b><br>- Trees identified for retention within the project limit would be protected during the works;<br>- The tree transplanting and planting works shall be implemented by approved Landscape Contractors.  | During construction | V              |
|  | <b>Temporary Works Areas</b><br>- Where feasible the works areas would be screened using hoarding and existing vegetation would be retained where possible to reduce the landscape and visual impacts arising from the construction activity. The landscape of these works areas would be restored following the completion of the construction phase. |                     | V              |
|  | <b>Hoarding</b><br>- A hoarding would be erected where practicable in the most visually sensitive locations to screen the temporary construction works from the local VSRs.  |                     | V              |
|  | <b>Top Soils</b><br>- The works will result in disturbance to extensive areas of topsoil. Topsoil worthy of retention should be stockpiled for use following completion of the civil engineering works. It should either be temporarily vegetated with hydroseeded grass or turned over on a regular basis.  |                     | #              |
|  | <b>Protection of Important Landscape Features</b><br>- Important features such as temples, Island House and kilns within the study area, although remote from the proposed works retained and adequately protected.  |                     | V              |

**Legend:**

- V = implemented;
- x = not implemented;
- @ = partially implemented;
- + = recommended and immediately implemented during the site inspection by the Contractor;
- N/A = not applicable - No such work was undertaken or no such material was used on site;
- # = to be implemented.

---

---

**APPENDIX D  
SUMMARY OF ACTION AND LIMIT LEVELS**

---

---

## Appendix D - Summary of Action and Limit Levels

Table 1 – Action and Limit Levels for 1-hour TSP

| Location | Action Level            | Limit Level           |
|----------|-------------------------|-----------------------|
| AM2      | 317.8 µg/m <sup>3</sup> | 500 µg/m <sup>3</sup> |

Table 2 – Action and Limit Levels for 24-hour TSP

| Location | Action Level            | Limit Level           |
|----------|-------------------------|-----------------------|
| AM2      | 200.7 µg/m <sup>3</sup> | 260 µg/m <sup>3</sup> |

Table 3 – Action and Limit Levels for Construction Noise (0700-1900 hrs of normal weekdays)

| Location | Action Level  | Limit Level |
|----------|---|-------------|
| M2       | When one documented complaint, related to 0700 – 1900 hours on normal weekdays, is received from any one of the sensitive receivers | 75 dB(A)    |
| M3*      |   | 65/70 dB(A) |

\*Daytime noise Limit Level of 70 dB(A) applies to education institutions, while 65dB(A) applies during school examination period



---

---

**APPENDIX E  
CALIBRATION CERTIFICATES OF  
MONITORING EQUIPMENTS**

---

---

# Certificate of Calibration

| Calibration Certification Information |                        |           |       |
|---------------------------------------|------------------------|-----------|-------|
| Cal. Date: June 5, 2020               | Rootsmeter S/N: 438320 | Ta: 295   | °K    |
| Operator: Jim Tisch                   |                        | Pa: 748.0 | mm Hg |
| Calibration Model #: TE-5025A         | Calibrator S/N: 0988   |           |       |

| Run | Vol. Init (m3) | Vol. Final (m3) | ΔVol. (m3) | ΔTime (min) | ΔP (mm Hg) | ΔH (in H2O) |
|-----|----------------|-----------------|------------|-------------|------------|-------------|
| 1   | 1              | 2               | 1          | 1.3610      | 3.2        | 2.00        |
| 2   | 3              | 4               | 1          | 0.9700      | 6.4        | 4.00        |
| 3   | 5              | 6               | 1          | 0.8630      | 7.9        | 5.00        |
| 4   | 7              | 8               | 1          | 0.8240      | 8.8        | 5.50        |
| 5   | 9              | 10              | 1          | 0.6800      | 12.9       | 8.00        |

| Data Tabulation |               |  |           |             |   |
|-----------------|---------------|--|-----------|-------------|---|
| Vstd (m3)       | Qstd (x-axis) | $\sqrt{\Delta H \left( \frac{Pa}{Pstd} \right) \left( \frac{Tstd}{Ta} \right)}$ (y-axis) | Va        | Qa (x-axis) | $\sqrt{\Delta H \left( \frac{Ta}{Pa} \right)}$ (y-axis) |
| 0.9900          | 0.7274        | 1.4101   | 0.9957    | 0.7316      | 0.8881  |
| 0.9858          | 1.0162        | 1.9943   | 0.9914    | 1.0221      | 1.2560  |
| 0.9838          | 1.1399        | 2.2296   | 0.9894    | 1.1465      | 1.4042  |
| 0.9826          | 1.1924        | 2.3385   | 0.9882    | 1.1993      | 1.4728  |
| 0.9771          | 1.4369        | 2.8203   | 0.9828    | 1.4452      | 1.7762  |
| <b>QSTD</b>     | m=            | <b>1.98556</b>   | <b>QA</b> | m=          | <b>1.24332</b>  |
|                 | b=            | <b>-0.03069</b>  |           | b=          | <b>-0.01933</b>   |
|                 | r=            | <b>0.99996</b>   |           | r=          | <b>0.99996</b>  |

| Calculations   |   |
|--|---|
| Vstd= $\Delta Vol \left( \frac{Pa - \Delta P}{Pstd} \right) \left( \frac{Tstd}{Ta} \right)$                                  | Va= $\Delta Vol \left( \frac{Pa - \Delta P}{Pa} \right)$                                  |
| Qstd= Vstd/ΔTime   | Qa= Va/ΔTime  |
| For subsequent flow rate calculations:   |   |
| $Qstd = 1/m \left( \left( \sqrt{\Delta H \left( \frac{Pa}{Pstd} \right) \left( \frac{Tstd}{Ta} \right)} \right) - b \right)$ | $Qa = 1/m \left( \left( \sqrt{\Delta H \left( \frac{Ta}{Pa} \right)} \right) - b \right)$ |

| Standard Conditions |                                       |
|---------------------|---------------------------------------|
| Tstd:               | 298.15 °K                             |
| Pstd:               | 760 mm Hg                             |
| Key                 |                                       |
| ΔH:                 | calibrator manometer reading (in H2O) |
| ΔP:                 | rootsmeter manometer reading (mm Hg)  |
| Ta:                 | actual absolute temperature (°K)      |
| Pa:                 | actual barometric pressure (mm Hg)    |
| b:                  | intercept                             |
| m:                  | slope                                 |

| RECALIBRATION  |
|--|
| US EPA recommends annual recalibration per 1998 40 Code of Federal Regulations Part 50 to 51, Appendix B to Part 50, Reference Method for the Determination of Suspended Particulate Matter in the Atmosphere, 9.2.17, page 30 |



## EQUIPMENT CALIBRATION RECORD

Type: Laser Dust Monitor  
 Manufacturer/Brand: SIBATA  
 Model No.: LD-3  
 Equipment No.: A.005.07a  
 Sensitivity Adjustment Scale Setting: 557 CPM

Operator: Mike Shek (MSKM)

### Standard Equipment

Equipment: Rupprecht & Patashnick TEOM®  
 Venue: Cyberport (Pui Ying Secondary School)  
 Model No.: Series 1400AB  
 Serial No: Control: 140AB219899803  
 Sensor: 1200C143659803 Ko: 12500  
 Last Calibration Date\*: 1 May 2020

\*Remarks: Recommended interval for hardware calibration is 1 year

### Calibration Result

Sensitivity Adjustment Scale Setting (Before Calibration): 557 CPM  
 Sensitivity Adjustment Scale Setting (After Calibration): 557 CPM

| Hour | Date<br>(dd-mm-yy) | Time          | Ambient Condition |             | Concentration <sup>1</sup><br>(mg/m <sup>3</sup> )<br>Y-axis | Total Count <sup>2</sup> | Count/<br>Minute <sup>3</sup><br>X-axis |
|------|--------------------|---------------|-------------------|-------------|--|--------------------------|---|
|      |                    |               | Temp<br>(°C)      | R.H.<br>(%) |  |                          |   |
| 1    | 02-05-20           | 09:15 - 10:15 | 26.7              | 77          | 0.04836  | 1945                     | 32.42                                   |
| 2    | 02-05-20           | 10:15 - 11:15 | 26.7              | 77          | 0.05134  | 2056                     | 34.27                                   |
| 3    | 02-05-20           | 11:15 - 12:15 | 26.8              | 77          | 0.05331  | 2130                     | 35.50                                   |
| 4    | 02-05-20           | 12:15 - 13:15 | 26.8              | 77          | 0.05535  | 2214                     | 36.90                                   |

- Note:
1. Monitoring data was measured by Rupprecht & Patashnick TEOM®
  2. Total Count was logged by Laser Dust Monitor
  3. Count/minute was calculated by (Total Count/60)

By Linear Regression of Y or X

Slope (K-factor): 0.0015  
 Correlation coefficient: 0.9976

Validity of Calibration Record: 2 May 2021

Remarks:

QC Reviewer: YW Fung

Signature: 

Date: 04 May 2020

## EQUIPMENT CALIBRATION RECORD

Type: Laser Dust Monitor  
 Manufacturer/Brand: SIBATA  
 Model No.: LD-3  
 Equipment No.: A.005.09a  
 Sensitivity Adjustment Scale Setting: 797 CPM

Operator: Mike Shek (MSKM)

### Standard Equipment

Equipment: Rupprecht & Patashnick TEOM®  
 Venue: Cyberport (Pui Ying Secondary School)  
 Model No.: Series 1400AB  
 Serial No: Control: 140AB219899803  
 Sensor: 1200C143659803 Ko: 12500  
 Last Calibration Date\*: 1 May 2020

\*Remarks: Recommended interval for hardware calibration is 1 year

### Calibration Result

Sensitivity Adjustment Scale Setting (Before Calibration): 797 CPM  
 Sensitivity Adjustment Scale Setting (After Calibration): 797 CPM

| Hour | Date<br>(dd-mm-yy) | Time          | Ambient Condition |             | Concentration <sup>1</sup><br>(mg/m <sup>3</sup> )<br>Y-axis | Total Count <sup>2</sup> | Count/<br>Minute <sup>3</sup><br>X-axis |
|------|--------------------|---------------|-------------------|-------------|--|--------------------------|---|
|      |                    |               | Temp<br>(°C)      | R.H.<br>(%) |  |                          |   |
| 1    | 02-05-20           | 09:45 - 10:45 | 26.7              | 77          | 0.04884  | 1956                     | 32.60                                   |
| 2    | 02-05-20           | 10:45 - 11:45 | 26.7              | 77          | 0.05157  | 2070                     | 34.50                                   |
| 3    | 02-05-20           | 11:45 - 12:45 | 26.8              | 77          | 0.05355  | 2158                     | 35.97                                   |
| 4    | 02-05-20           | 12:45 - 13:45 | 26.8              | 77          | 0.05593  | 2241                     | 37.35                                   |

- Note:
1. Monitoring data was measured by Rupprecht & Patashnick TEOM®
  2. Total Count was logged by Laser Dust Monitor
  3. Count/minute was calculated by (Total Count/60)

By Linear Regression of Y or X

Slope (K-factor): 0.0015  
 Correlation coefficient: 0.9974

Validity of Calibration Record: 2 May 2021

Remarks:

QC Reviewer: YW Fung

Signature: 

Date: 04 May 2020





## CERTIFICATE OF CALIBRATION

Certificate No.: 20CA0330 01

Page: 1 of 2

### Item tested

Description: Acoustical Calibrator (Class 1)  
Manufacturer: B & K  
Type/Model No.: 4231  
Serial/Equipment No.: 3006428  
Adaptors used: -

### Item submitted by

Customer: AECOM  
Address of Customer: -  
Request No.: -  
Date of receipt: 30-Mar-2020

LN.004037

Date of test: 31-Mar-2020

### Reference equipment used in the calibration

| Description:            | Model:   | Serial No. | Expiry Date: | Traceable to: |
|-------------------------|----------|------------|--------------|---------------|
| Lab standard microphone | B&K 4180 | 2341427    | 03-May-2020  | SCL           |
| Preamplifier            | B&K 2673 | 2239857    | 17-May-2020  | CEPREI        |
| Measuring amplifier     | B&K 2610 | 2346941    | 05-Jun-2020  | CEPREI        |
| Signal generator        | DS 360   | 33873      | 10-May-2020  | CEPREI        |
| Digital multi-meter     | 34401A   | US36087050 | 08-May-2020  | CEPREI        |
| Audio analyzer          | 8903B    | GB41300350 | 13-May-2020  | CEPREI        |
| Universal counter       | 53132A   | MY40003662 | 10-May-2020  | CEPREI        |

### Ambient conditions

Temperature:  $22 \pm 1$  °C  
Relative humidity:  $55 \pm 10$  %  
Air pressure:  $1005 \pm 5$  hPa

### Test specifications

- The Sound Calibrator has been calibrated in accordance with the requirements as specified in IEC 60942 1997 Annex B and the lab calibration procedure SMTP004-CA-156.
- The calibrator was tested with its axis vertical facing downwards at the specific frequency using insert voltage technique.
- The results are rounded to the nearest 0.01 dB and 0.1 Hz and have not been corrected for variations from a reference pressure of 1013.25 hectoPascals as the maker's information indicates that the instrument is insensitive to pressure changes.

### Test results

This is to certify that the sound calibrator conforms to the requirements of annex B of IEC 60942: 1997 for the conditions under which the test was performed. This does not imply that the sound calibrator meets IEC 60942 under any other conditions.

Details of the performed measurements are presented on **page 2** of this certificate.

Approved Signatory:

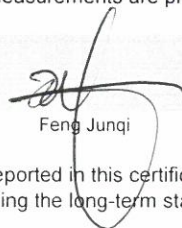
  
Feng Junqi

Date: 31-Mar-2020    Company Chop:



Comments: The results reported in this certificate refer to the condition of the instrument on the date of calibration and carry no implication regarding the long-term stability of the instrument.







## CERTIFICATE OF CALIBRATION

Certificate No.: 20CA0318 01 Page 1 of 2

### Item tested

|                       |                            |            |        |
|-----------------------|----------------------------|------------|--------|
| Description:          | Sound Level Meter (Type 1) | Microphone | Preamp |
| Manufacturer:         | B & K                      | B & K      | B & K  |
| Type/Model No.:       | 2250-L                     | 4950       | ZC0032 |
| Serial/Equipment No.: | 2681366                    | 2665582    | 17190  |
| Adaptors used:        | -                          | -          | -      |

### Item submitted by

Customer Name: AECOM ASIA CO LTD  
Address of Customer: -  
Request No.: -  
Date of receipt: 18-Mar-2020

Date of test: 19-Mar-2020

### Reference equipment used in the calibration

| Description:                    | Model:   | Serial No. | Expiry Date: | Traceable to: |
|---------------------------------|----------|------------|--------------|---------------|
| Multi function sound calibrator | B&K 4226 | 2288444    | 23-Aug-2020  | CIGISMEC      |
| Signal generator                | DS 360   | 33873      | 10-May-2020  | CEPREI        |

### Ambient conditions

Temperature: 22 ± 1 °C  
Relative humidity: 55 ± 10 %  
Air pressure: 1005 ± 5 hPa

### Test specifications

- 1, The Sound Level Meter has been calibrated in accordance with the requirements as specified in BS 7580: Part 1: 1997 and the lab calibration procedure SMTP004-CA-152.
- 2, The electrical tests were performed using an electrical signal substituted for the microphone which was removed and replaced by an equivalent capacitance within a tolerance of +20%.
- 3, The acoustic calibration was performed using an B&K 4226 sound calibrator and corrections was applied for the difference between the free-field and pressure responsiveness of the Sound Level Meter.

### Test results

This is to certify that the Sound Level Meter conforms to BS 7580: Part 1: 1997 for the conditions under which the test was performed.

Details of the performed measurements are presented on page 2 of this certificate.

Actual Measurement data are documented on worksheets.

Approved Signatory:

  
Feng Junqi

Date: 19-Mar-2020

Company Chop:



Comments: The results reported in this certificate refer to the condition of the instrument on the date of calibration and carry no implication regarding the long-term stability of the instrument.





## CERTIFICATE OF CALIBRATION

(Continuation Page)

Certificate No.: 20CA0318 01 Page 2 of 2

### 1, Electrical Tests

The electrical tests were performed using an equivalent capacitance substituted for the microphone. The results are given in below with test status and the estimated uncertainties. The "Pass" means the result of the test is inside the tolerances stated in the test specifications. The "-" means the result of test is outside these tolerances.

| Test:                   | Subtest:   | Status: | Expanded Uncertainty (dB) | Coverage Factor |
|-------------------------|--|---------|---------------------------|-----------------|
| Self-generated noise    | A  | Pass    | 0.3                       |                 |
|                         | C  | Pass    | 0.8                       |                 |
|                         | Lin  | Pass    | 1.6                       |                 |
| Linearity range for Leq | At reference range, Step 5 dB at 4 kHz           | Pass    | 0.3                       |                 |
|                         | Reference SPL on all other ranges                | Pass    | 0.3                       |                 |
|                         | 2 dB below upper limit of each range             | Pass    | 0.3                       |                 |
|                         | 2 dB above lower limit of each range             | Pass    | 0.3                       |                 |
|                         | At reference range, Step 5 dB at 4 kHz           | Pass    | 0.3                       |                 |
| Linearity range for SPL | A  | Pass    | 0.3                       |                 |
|                         | C  | Pass    | 0.3                       |                 |
|                         | Lin  | Pass    | 0.3                       |                 |
| Time weightings         | Single Burst Fast                                | Pass    | 0.3                       |                 |
|                         | Single Burst Slow                                | Pass    | 0.3                       |                 |
|                         | Single 100µs rectangular pulse                   | Pass    | 0.3                       |                 |
| Peak response           | Crest factor of 3                                | Pass    | 0.3                       |                 |
| R.M.S. accuracy         | Single burst 5 ms at 2000 Hz                     | Pass    | 0.3                       |                 |
|                         | Repeated at frequency of 100 Hz                  | Pass    | 0.3                       |                 |
| Time averaging          | 1 ms burst duty factor 1/10 <sup>3</sup> at 4kHz | Pass    | 0.3                       |                 |
|                         | 1 ms burst duty factor 1/10 <sup>4</sup> at 4kHz | Pass    | 0.3                       |                 |
| Pulse range             | Single burst 10 ms at 4 kHz                      | Pass    | 0.4                       |                 |
| Sound exposure level    | Single burst 10 ms at 4 kHz                      | Pass    | 0.4                       |                 |
| Overload indication     | SPL  | Pass    | 0.3                       |                 |
|                         | Leq  | Pass    | 0.4                       |                 |

### 2, Acoustic tests

The complete sound level meter was calibrated on the reference range using a B&K 4226 acoustic calibrator with 1000Hz and SPL 94 dB. The sensitivity of the sound level meter was adjusted. The test result at 125 Hz and 8000 Hz are given in below with test status and the estimated uncertainties.

| Test:             | Subtest                | Status | Expanded Uncertainty (dB) | Coverage Factor |
|-------------------|------------------------|--------|---------------------------|-----------------|
| Acoustic response | Weighting A at 125 Hz  | Pass   | 0.3                       |                 |
|                   | Weighting A at 8000 Hz | Pass   | 0.5                       |                 |

### 3, Response to associated sound calibrator

N/A

The expanded uncertainties have been calculated in accordance with the ISO Publication "Guide to the expression of uncertainty in measurement", and gives an interval estimated to have a level of confidence of 95%. A coverage factor of 2 is assumed unless explicitly stated.

Calibrated by:

Date:

Fung Chi Yip  
19-Mar-2020

- End -

Checked by:

Date:

Shek Kwong Tat  
19-Mar-2020

The standard(s) and equipment used in the calibration are traceable to national or international recognised standards and are calibrated on a schedule to maintain the required accuracy level.



## CERTIFICATE OF CALIBRATION

Certificate No.: 19CA0912 01 Page 1 of 2

### Item tested

|                       |                            |            |
|-----------------------|----------------------------|------------|
| Description:          | Sound Level Meter (Type 1) | Microphone |
| Manufacturer:         | B & K                      | B & K      |
| Type/Model No.:       | 2238                       | 4188       |
| Serial/Equipment No.: | 2800927                    | 2791211    |
| Adaptors used:        | -                          | -          |

### Item submitted by

Customer Name: AECOM ASIA CO., LTD.  
Address of Customer: -  
Request No.: -  
Date of receipt: 12-Sep-2019

Date of test: 16-Sep-2019

### Reference equipment used in the calibration

| Description:                    | Model:   | Serial No. | Expiry Date: | Traceable to: |
|---------------------------------|----------|------------|--------------|---------------|
| Multi function sound calibrator | B&K 4226 | 2288444    | 23-Aug-2020  | CIGISMEC      |
| Signal generator                | DS 360   | 61227      | 26-Dec-2019  | CEPREI        |

### Ambient conditions

Temperature:  $21 \pm 1$  °C  
Relative humidity:  $55 \pm 10$  %  
Air pressure:  $1000 \pm 5$  hPa

### Test specifications

- 1, The Sound Level Meter has been calibrated in accordance with the requirements as specified in BS 7580: Part 1: 1997 and the lab calibration procedure SMTP004-CA-152.
- 2, The electrical tests were performed using an electrical signal substituted for the microphone which was removed and replaced by an equivalent capacitance within a tolerance of  $\pm 20\%$ .
- 3, The acoustic calibration was performed using an B&K 4226 sound calibrator and corrections was applied for the difference between the free-field and pressure responses of the Sound Level Meter.

### Test results

This is to certify that the Sound Level Meter conforms to BS 7580: Part 1: 1997 for the conditions under which the test was performed.

Details of the performed measurements are presented on page 2 of this certificate.

Actual Measurement data are documented on worksheets.

Approved Signatory:

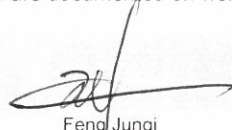
  
Feng Junqi

Date: 16-Sep-2019

Company Chop:



Comments: The results reported in this certificate refer to the condition of the instrument on the date of calibration and carry no implication regarding the long-term stability of the instrument.



## CERTIFICATE OF CALIBRATION

(Continuation Page)

Certificate No.: 19CA0912 01

Page 2 of 2

### 1, Electrical Tests

The electrical tests were performed using an equivalent capacitance substituted for the microphone. The results are given in below with test status and the estimated uncertainties. The "Pass" means the result of the test is inside the tolerances stated in the test specifications. The "-" means the result of test is outside these tolerances.

| Test:                   | Subtest:   | Status: | Expanded Uncertainty (dB) | Coverage Factor |
|-------------------------|--|---------|---------------------------|-----------------|
| Self-generated noise    | A  | Pass    | 0.3                       | 2.1             |
|                         | C  | Pass    | 1.0                       |                 |
|                         | Lin  | Pass    | 2.0                       |                 |
| Linearity range for Leq | At reference range, Step 5 dB at 4 kHz           | Pass    | 0.3                       | 2.2             |
|                         | Reference SPL on all other ranges                | Pass    | 0.3                       |                 |
|                         | 2 dB below upper limit of each range             | Pass    | 0.3                       |                 |
|                         | 2 dB above lower limit of each range             | Pass    | 0.3                       |                 |
|                         | At reference range, Step 5 dB at 4 kHz           | Pass    | 0.3                       |                 |
| Linearity range for SPL | A  | Pass    | 0.3                       | 2.2             |
|                         | C  | Pass    | 0.3                       |                 |
|                         | Lin  | Pass    | 0.3                       |                 |
| Time weightings         | Single Burst Fast                                | Pass    | 0.3                       | 2.2             |
|                         | Single Burst Slow                                | Pass    | 0.3                       |                 |
| Peak response           | Single 100µs rectangular pulse                   | Pass    | 0.3                       | 2.2             |
| R.M.S. accuracy         | Crest factor of 3                                | Pass    | 0.3                       |                 |
| Time weighting I        | Single burst 5 ms at 2000 Hz                     | Pass    | 0.3                       | 2.2             |
|                         | Repeated at frequency of 100 Hz                  | Pass    | 0.3                       |                 |
| Time averaging          | 1 ms burst duty factor 1/10 <sup>3</sup> at 4kHz | Pass    | 0.3                       | 2.2             |
|                         | 1 ms burst duty factor 1/10 <sup>4</sup> at 4kHz | Pass    | 0.3                       |                 |
| Pulse range             | Single burst 10 ms at 4 kHz                      | Pass    | 0.4                       | 2.2             |
| Sound exposure level    | Single burst 10 ms at 4 kHz                      | Pass    | 0.4                       |                 |
| Overload indication     | SPL  | Pass    | 0.3                       | 2.2             |
|                         | Leq  | Pass    | 0.4                       |                 |

### 2, Acoustic tests

The complete sound level meter was calibrated on the reference range using a B&K 4226 acoustic calibrator with 1000Hz and SPL 94 dB. The sensitivity of the sound level meter was adjusted. The test result at 125 Hz and 8000 Hz are given in below with test status and the estimated uncertainties.

| Test:             | Subtest                | Status | Expanded Uncertainty (dB) | Coverage Factor |
|-------------------|------------------------|--------|---------------------------|-----------------|
| Acoustic response | Weighting A at 125 Hz  | Pass   | 0.3                       | 2.2             |
|                   | Weighting A at 8000 Hz | Pass   | 0.5                       |                 |

### 3, Response to associated sound calibrator

N/A

The expanded uncertainties have been calculated in accordance with the ISO Publication "Guide to the expression of uncertainty in measurement", and gives an interval estimated to have a level of confidence of 95%. A coverage factor of 2 is assumed unless explicitly stated.

Calibrated by:

Date:

Fung Chi Yip  
16-Sep-2019

- End -

Checked by:

Date:

Shek Kwong Tai  
16-Sep-2019

The standard(s) and equipment used in the calibration are traceable to national or international recognised standards and are calibrated on a schedule to maintain the required accuracy level.

---

---

**APPENDIX F  
EM&A MONITORING SCHEDULES**

---

---

**Contract No. HY/2012/06**  
**Widening of Fanling Highway – Tai Hang to Wo Hop Shek Interchange**  
**Impact Monitoring and Audit Schedule for August 2020**

| Sunday | Monday                         | Tuesday                                      | Wednesday | Thursday                       | Friday                         | Saturday              |
|--------|--------------------------------|--|-----------|--------------------------------|--------------------------------|-----------------------|
|        |                                |  |           |                                |                                | 1-Aug                 |
|        |                                |  |           |                                |                                |                       |
| 2-Aug  | 3-Aug                          | 4-Aug  | 5-Aug     | 6-Aug                          | 7-Aug                          | 8-Aug                 |
|        |                                | 1-hr TSP<br>24-hr TSP<br>Noise<br>Site Audit |           |                                |                                |                       |
| 9-Aug  | 10-Aug                         | 11-Aug                                       | 12-Aug    | 13-Aug                         | 14-Aug                         | 15-Aug                |
|        | 1-hr TSP<br>24-hr TSP<br>Noise |  |           |                                |                                | 1-hr TSP<br>24-hr TSP |
|        |                                | Site Audit                                   |           |                                |                                |                       |
| 16-Aug | 17-Aug                         | 18-Aug                                       | 19-Aug    | 20-Aug                         | 21-Aug                         | 22-Aug                |
|        |                                |  |           |                                | 1-hr TSP<br>24-hr TSP<br>Noise |                       |
|        |                                | Site Audit                                   |           |                                |                                |                       |
| 23-Aug | 24-Aug                         | 25-Aug                                       | 26-Aug    | 27-Aug                         | 28-Aug                         | 29-Aug                |
|        |                                |  |           | 1-hr TSP<br>24-hr TSP<br>Noise |                                |                       |
|        |                                | Site Audit                                   |           |                                |                                |                       |
| 30-Aug | 31-Aug                         |  |           |                                |                                |                       |
|        |                                |  |           |                                |                                |                       |

**Contract No. HY/2012/06**  
**Widening of Fanling Highway – Tai Hang to Wo Hop Shek Interchange**  
**Tentative Impact Monitoring and Audit Schedule for September 2020**

| Sunday | Monday                         | Tuesday                                      | Wednesday                      | Thursday | Friday                         | Saturday              |
|--------|--------------------------------|--|--------------------------------|----------|--------------------------------|-----------------------|
|        |                                | 1-Sep  | 2-Sep                          | 3-Sep    | 4-Sep                          | 5-Sep                 |
|        |                                |  | 1-hr TSP<br>24-hr TSP<br>Noise |          |                                |                       |
| 6-Sep  | 7-Sep                          | 8-Sep  | 9-Sep                          | 10-Sep   | 11-Sep                         | 12-Sep                |
|        |                                | 1-hr TSP<br>24-hr TSP<br>Noise<br>Site Audit |                                |          |                                |                       |
| 13-Sep | 14-Sep                         | 15-Sep                                       | 16-Sep                         | 17-Sep   | 18-Sep                         | 19-Sep                |
|        | 1-hr TSP<br>24-hr TSP<br>Noise | Site Audit                                   |                                |          |                                | 1-hr TSP<br>24-hr TSP |
| 20-Sep | 21-Sep                         | 22-Sep                                       | 23-Sep                         | 24-Sep   | 25-Sep                         | 26-Sep                |
|        |                                | Site Audit                                   |                                |          | 1-hr TSP<br>24-hr TSP<br>Noise |                       |
| 27-Sep | 28-Sep                         | 29-Sep                                       | 30-Sep                         |          |                                |                       |
|        |                                | Site Audit                                   | 1-hr TSP<br>24-hr TSP<br>Noise |          |                                |                       |

The schedule is subject to change due to unforeseeable circumstances (e.g. adverse weather, etc)

---

---

**APPENDIX G  
IMPACT AIR QUALITY MONITORING  
RESULTS AND THEIR GRAPHICAL  
PRESENTATION**

---

---

**Appendix G**  
**Impact Air Quality Monitoring Results**

**1-hour TSP Monitoring Results at Station AM2**  
**(Fanling Government Secondary School)**

| Date      | Start Time (hh:mm) | 1st Hour                           | 2nd Hour                           | 3rd Hour                           |
|-----------|--------------------|------------------------------------|------------------------------------|------------------------------------|
|           |                    | Conc. ( $\mu\text{g}/\text{m}^3$ ) | Conc. ( $\mu\text{g}/\text{m}^3$ ) | Conc. ( $\mu\text{g}/\text{m}^3$ ) |
| 4-Aug-20  | 11:40              | 62.2                               | 58.7                               | 60.9                               |
| 10-Aug-20 | 10:10              | 68.6                               | 67.9                               | 69.2                               |
| 15-Aug-20 | 10:05              | 62.2                               | 60.7                               | 58.4                               |
| 21-Aug-20 | 13:05              | 58.2                               | 57.1                               | 59.5                               |
| 27-Aug-20 | 13:10              | 59.6                               | 60.6                               | 57.6                               |
|           |                    | Average                            | 61.4                               |                                    |
|           |                    | Min                                | 57.1                               |                                    |
|           |                    | Max                                | 69.2                               |                                    |



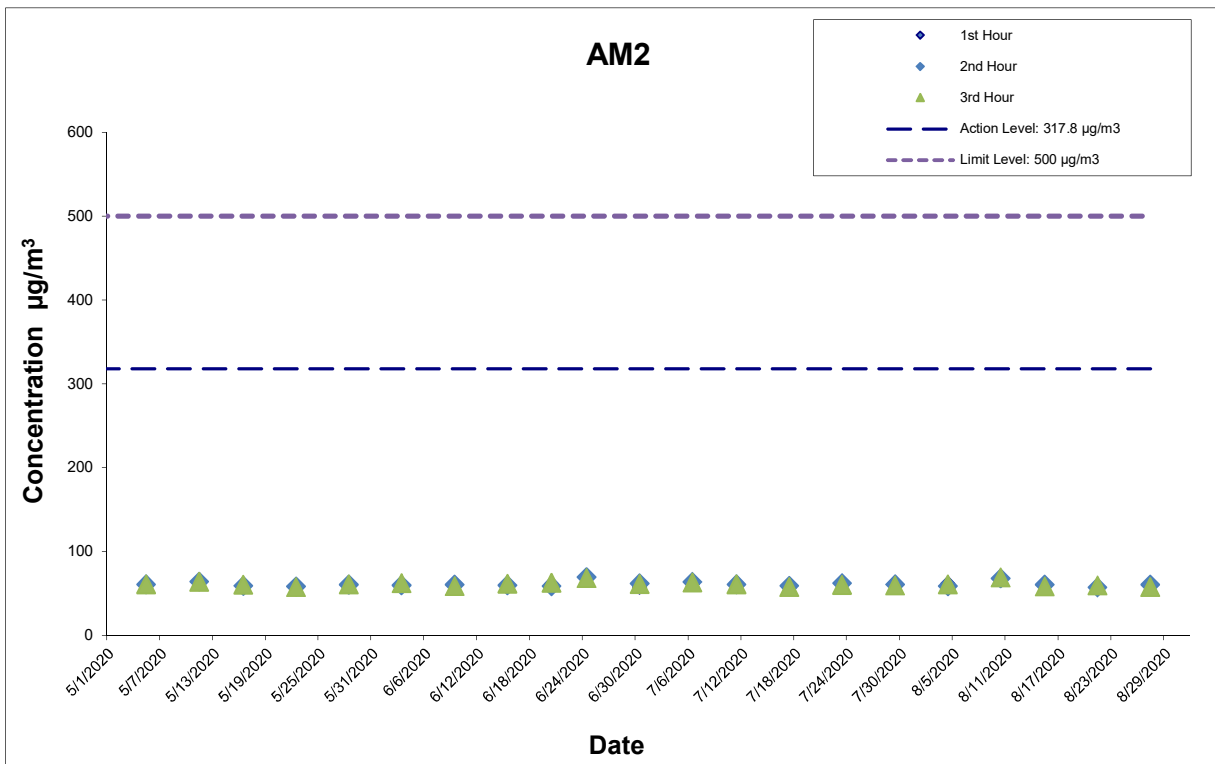

This Drawing has been prepared for the use of AECOM's client. It may not be used, modified, reproduced or relied upon by third parties, except as agreed by AECOM or as required by law. AECOM accepts no responsibility, and denies any liability whatsoever, to any party that uses or relies on this drawing without AECOM's express written consent.

CONTRACT NO. HY/2012/06  
 WIDENING OF FANLING HIGHWAY  
 - TAI HANG TO WO HOP SHEK INTERCHANGE



Graphical Presentation of Impact 1-hour TSP Monitoring Results

**Appendix G  
Impact Air Quality Monitoring Results**

**24-hour TSP Monitoring Results at Station AM2 (Fanling Government Secondary School)**

| Date      | Weather Condition | Air Temp. (°C) | Atmospheric Pressure(hPa) | Flow Rate (m <sup>3</sup> /min.) |       | Av. flow (m <sup>3</sup> /min) | Total vol. (m <sup>3</sup> ) | Filter Weight (g) |        | Particulate weight(g) | Elapse Time |          | Sampling Time(hrs.) | Conc. (µg/m <sup>3</sup> ) | Action Level (µg/m <sup>3</sup> ) | Limit Level (µg/m <sup>3</sup> ) |
|-----------|-------------------|----------------|---------------------------|----------------------------------|-------|--------------------------------|------------------------------|-------------------|--------|-----------------------|-------------|----------|---------------------|----------------------------|-----------------------------------|----------------------------------|
|           |                   |                |                           | Initial                          | Final |                                |                              | Initial           | Final  |                       | Initial     | Final    |                     |                            |                                   |                                  |
| 4-Aug-20  | Fine              | 27.5           | 1004.0                    | 1.331                            | 1.331 | 1.331                          | 1916.6                       | 2.6400            | 2.6653 | 0.0253                | 14806.02    | 14830.02 | 24.00               | 13.2                       | 200.7                             | 260                              |
| 10-Aug-20 | Sunny             | 30.0           | 1004.3                    | 1.331                            | 1.331 | 1.331                          | 1916.6                       | 2.6149            | 2.6547 | 0.0398                | 14830.02    | 14854.02 | 24.00               | 20.8                       | 200.7                             | 260                              |
| 15-Aug-20 | Sunny             | 29.8           | 1008.6                    | 1.331                            | 1.331 | 1.331                          | 1916.6                       | 2.6432            | 2.6755 | 0.0323                | 14854.02    | 14878.02 | 24.00               | 16.9                       | 200.7                             | 260                              |
| 21-Aug-20 | Sunny             | 29.8           | 1009.0                    | 1.331                            | 1.331 | 1.331                          | 1916.6                       | 2.6672            | 2.7086 | 0.0414                | 14878.02    | 14902.02 | 24.00               | 21.6                       | 200.7                             | 260                              |
| 27-Aug-20 | Sunny             | 28.5           | 10005.0                   | 1.331                            | 1.331 | 1.331                          | 1916.6                       | 2.6707            | 2.7097 | 0.0390                | 14902.02    | 14926.02 | 24.00               | 20.3                       | 200.7                             | 260                              |
|           |                   |                |                           |                                  |       |                                |                              |                   |        |                       |             |          | Average             | 18.6                       |                                   |                                  |
|           |                   |                |                           |                                  |       |                                |                              |                   |        |                       |             |          | Min                 | 13.2                       |                                   |                                  |
|           |                   |                |                           |                                  |       |                                |                              |                   |        |                       |             |          | Max                 | 21.6                       |                                   |                                  |

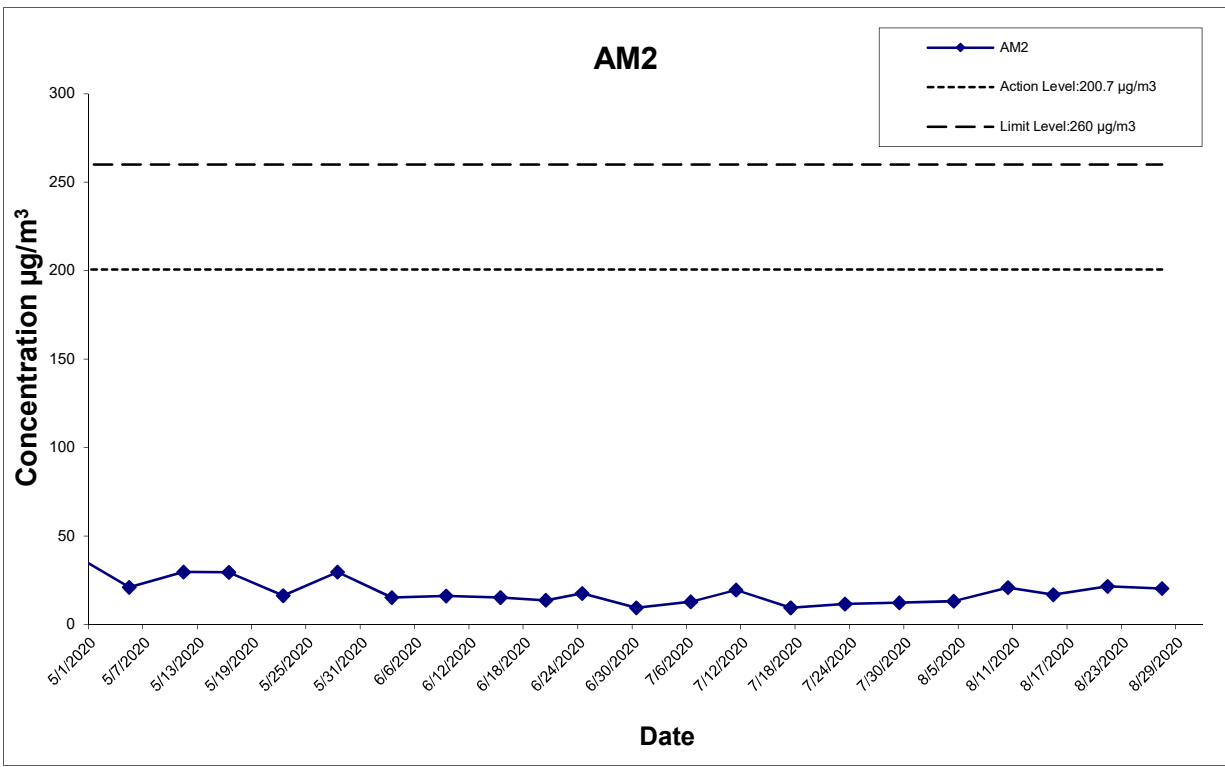

This Drawing has been prepared for the use of AECOM's client. It may not be used, modified, reproduced or relied upon by third parties, except as agreed by AECOM or as required by law. AECOM accepts no responsibility, and denies any liability whatsoever, to any party that uses or relies on this drawing without AECOM's express written consent.

CONTRACT NO. HY/2012/06  
 WIDENING OF FANLING HIGHWAY  
 - TAI HANG TO WO HOP SHEK INTERCHANGE



Graphical Presentation of Impact 24-hour TSP Monitoring Results

Project No.: 60307376

Date: Sep-20

Appendix G

---

---

**APPENDIX H  
METEOROLOGICAL DATA FOR THE  
REPORTING MONTH**

---

---

## Daily Extract

Daily Extract of Meteorological Observations , August 2020

 Year  Month  

| Day        | Hong Kong Observatory |                             |               |                             |                         |                            |                          |                     |
|------------|-----------------------|-----------------------------|---------------|-----------------------------|-------------------------|----------------------------|--------------------------|---------------------|
|            | Mean Pressure (hPa)   | Air Temperature             |               |                             | Mean Dew Point (deg. C) | Mean Relative Humidity (%) | Mean Amount of Cloud (%) | Total Rainfall (mm) |
|            |                       | Absolute Daily Max (deg. C) | Mean (deg. C) | Absolute Daily Min (deg. C) |                         |                            |                          |                     |
| 01         | 1004.1                | 29.4                        | 27.7          | 25.9                        | 25.3                    | 87                         | 90                       | 28.3                |
| 02         | 1004.2                | 29.4                        | 27.5          | 26.2                        | 25.6                    | 89                         | 88                       | 25.6                |
| 03         | 1003.5                | 27.8                        | 26.5          | 25.7                        | 25.3                    | 93                         | 88                       | 46.9                |
| 04         | 1004.0                | 30.1                        | 27.5          | 26.1                        | 25.2                    | 87                         | 86                       | 4.7                 |
| 05         | 1008.1                | 31.9                        | 27.8          | 24.9                        | 25.5                    | 88                         | 89                       | 53.3                |
| 06         | 1009.8                | 33.5                        | 29.1          | 25.2                        | 26.2                    | 85                         | 83                       | 1.7                 |
| 07         | 1008.0                | 33.9                        | 30.1          | 27.6                        | 26.1                    | 80                         | 82                       | 0.2                 |
| 08         | 1005.6                | 34.4                        | 30.5          | 28.4                        | 25.5                    | 76                         | 44                       | 0.0                 |
| 09         | 1004.1                | 33.4                        | 29.9          | 27.8                        | 25.1                    | 76                         | 46                       | 0.0                 |
| 10         | 1004.3                | 33.0                        | 30.0          | 28.3                        | 25.2                    | 76                         | 73                       | 0.0                 |
| 11         | 1006.3                | 32.2                        | 30.3          | 29.0                        | 25.9                    | 78                         | 83                       | 0.6                 |
| 12         | 1010.4                | 29.5                        | 27.8          | 26.6                        | 25.6                    | 88                         | 88                       | 29.4                |
| 13         | 1011.0                | 31.2                        | 28.1          | 26.0                        | 25.4                    | 86                         | 83                       | 16.5                |
| 14         | 1009.7                | 33.4                        | 29.3          | 26.2                        | 25.3                    | 80                         | 59                       | 9.3                 |
| 15         | 1008.6                | 33.0                        | 29.8          | 27.9                        | 25.1                    | 76                         | 61                       | 0.0                 |
| 16         | 1008.6                | 33.8                        | 30.1          | 26.8                        | 25.3                    | 76                         | 79                       | Trace               |
| 17         | 1008.5                | 31.4                        | 28.2          | 26.4                        | 25.2                    | 84                         | 72                       | 16.6                |
| 18         | 1006.2                | 29.9                        | 27.3          | 25.6                        | 24.4                    | 85                         | 74                       | 52.7                |
| 19         | 1006.0                | 27.9                        | 26.6          | 24.9                        | 25.0                    | 91                         | 93                       | 119.5               |
| 20         | 1009.1                | 32.2                        | 29.0          | 27.2                        | 25.7                    | 83                         | 75                       | Trace               |
| 21         | 1009.0                | 33.5                        | 29.8          | 27.6                        | 25.3                    | 77                         | 71                       | 0.0                 |
| 22         | 1008.2                | 33.3                        | 29.7          | 27.2                        | 25.0                    | 77                         | 51                       | 0.0                 |
| 23         | 1006.8                | 33.8                        | 29.8          | 27.5                        | 25.3                    | 77                         | 60                       | 0.0                 |
| 24         | 1005.1                | 33.4                        | 30.2          | 27.9                        | 25.4                    | 76                         | 59                       | 0.0                 |
| 25         | 1003.7                | 33.8                        | 30.6          | 28.6                        | 26.1                    | 77                         | 63                       | 1.1                 |
| 26         | 1001.9                | 32.7                        | 29.7          | 26.5                        | 26.0                    | 81                         | 77                       | 12.3                |
| 27         | 1000.5                | 31.0                        | 28.5          | 26.4                        | 25.2                    | 83                         | 81                       | 3.1                 |
| 28         | 1002.8                | 34.2                        | 28.9          | 25.0                        | 25.4                    | 82                         | 79                       | 22.6                |
| 29         | 1004.4                | 33.2                        | 29.9          | 27.8                        | 25.4                    | 77                         | 40                       | 3.2                 |
| 30         | 1005.4                | 32.4                        | 29.6          | 28.0                        | 25.7                    | 80                         | 58                       | 0.6                 |
| 31         | 1006.2                | 34.3                        | 29.8          | 28.2                        | 25.1                    | 76                         | 79                       | 0.2                 |
| Mean/Total | 1006.3                | 32.2                        | 29.0          | 26.9                        | 25.4                    | 82                         | 73                       | 448.4               |
| Normal?    | 1005.2                | 31.1                        | 28.6          | 26.6                        | 25.0                    | 81                         | 69                       | 432.2               |

Trace means rainfall less than 0.05 mm  
 ? 1981-2010 Climatological Normal

---

---

**APPENDIX I  
IMPACT DAYTIME CONSTRUCTION NOISE  
MONITORING RESULTS AND THEIR  
GRAPHICAL PRESENTATION**

---

---

**Appendix I Impact Daytime Construction Noise Monitoring Results**

**Location : M2 (West Tai Wo - Free Field)**

Day time 07:00-19:00 hrs Normal Weekdays Impact Noise Monitoring Results

| Date      | Measured Noise Level for 30-min, dB(A) |      |      |      | Limit Level, dB(A) | Exceedance (Y/N) |
|-----------|--|------|------|------|--------------------|------------------|
|           | Start Time                             | Leq* | L10* | L90* |                    |                  |
| 4-Aug-20  | 13:50                                  | 66.3 | 68.2 | 64.6 | 75                 | N                |
| 10-Aug-20 | 13:10                                  | 66.3 | 67.5 | 63.5 | 75                 | N                |
| 21-Aug-20 | 13:50                                  | 66.7 | 67.5 | 64.5 | 75                 | N                |
| 27-Aug-20 | 13:35                                  | 65.5 | 67.0 | 63.0 | 75                 | N                |
|           | Min                                    | 65.5 | 67.0 | 63.0 |                    |                  |
|           | Max                                    | 66.7 | 68.2 | 64.6 |                    |                  |
|           | Average                                | 66.2 | 67.6 | 64.0 |                    |                  |

**Location : M3 (Fanling Government Secondary School- Façade)**

Day time 07:00-19:00 hrs Normal Weekdays Impact Noise Monitoring Results

| Date      | Measured Noise Level for 30-min, dB(A) |      |      |      | Limit Level, dB(A)^ | Exceedance (Y/N) |
|-----------|--|------|------|------|---------------------|------------------|
|           | Start Time                             | Leq* | L10* | L90* |                     |                  |
| 4-Aug-20  | 14:40                                  | 63.1 | 64.5 | 60.8 | 70                  | N                |
| 10-Aug-20 | 10:05                                  | 63.2 | 65.0 | 61.5 | 70                  | N                |
| 21-Aug-20 | 13:05                                  | 60.6 | 61.5 | 56.5 | 70                  | N                |
| 27-Aug-20 | 13:10                                  | 60.6 | 62.0 | 56.5 | 70                  | N                |
|           | Min                                    | 60.6 | 61.5 | 56.5 |                     |                  |
|           | Max                                    | 63.2 | 65.0 | 61.5 |                     |                  |
|           | Average                                | 62.1 | 63.5 | 59.4 |                     |                  |

\* +3dB(A) Façade effect correction included

^ Limit Level of 70dB(A) applies to education institutes while 65dB(A) applies during school examination period.

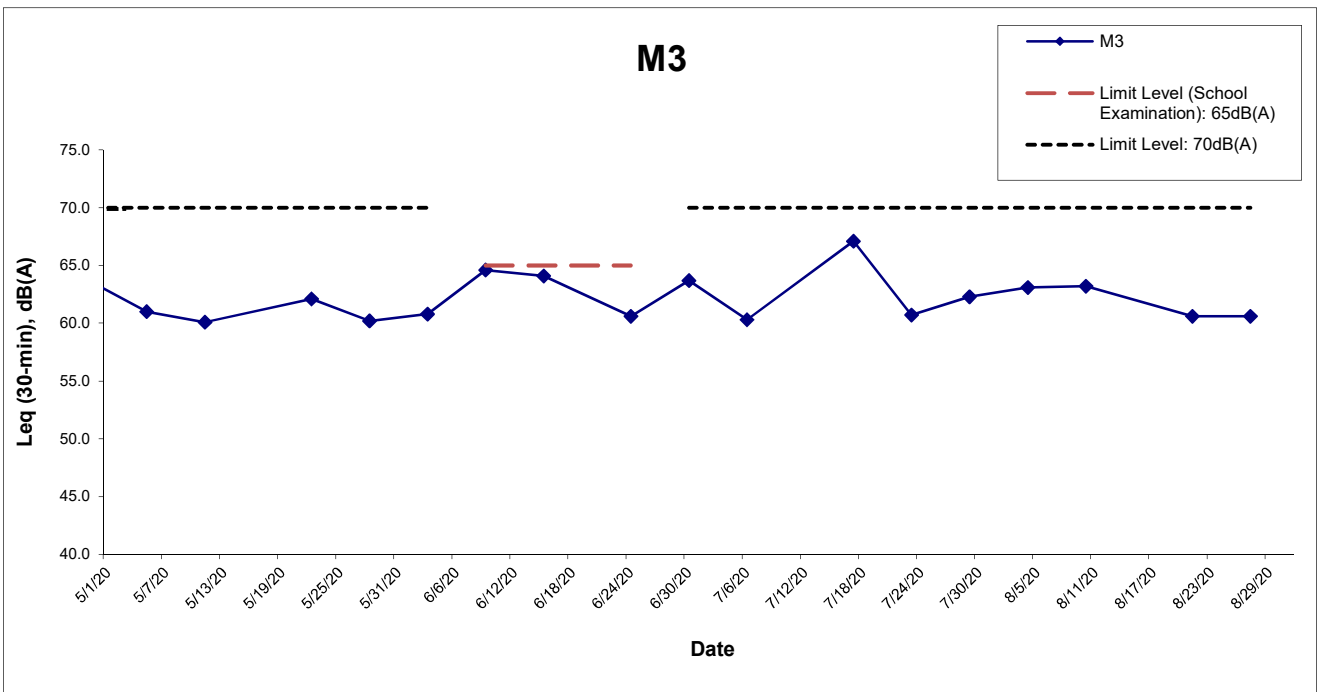
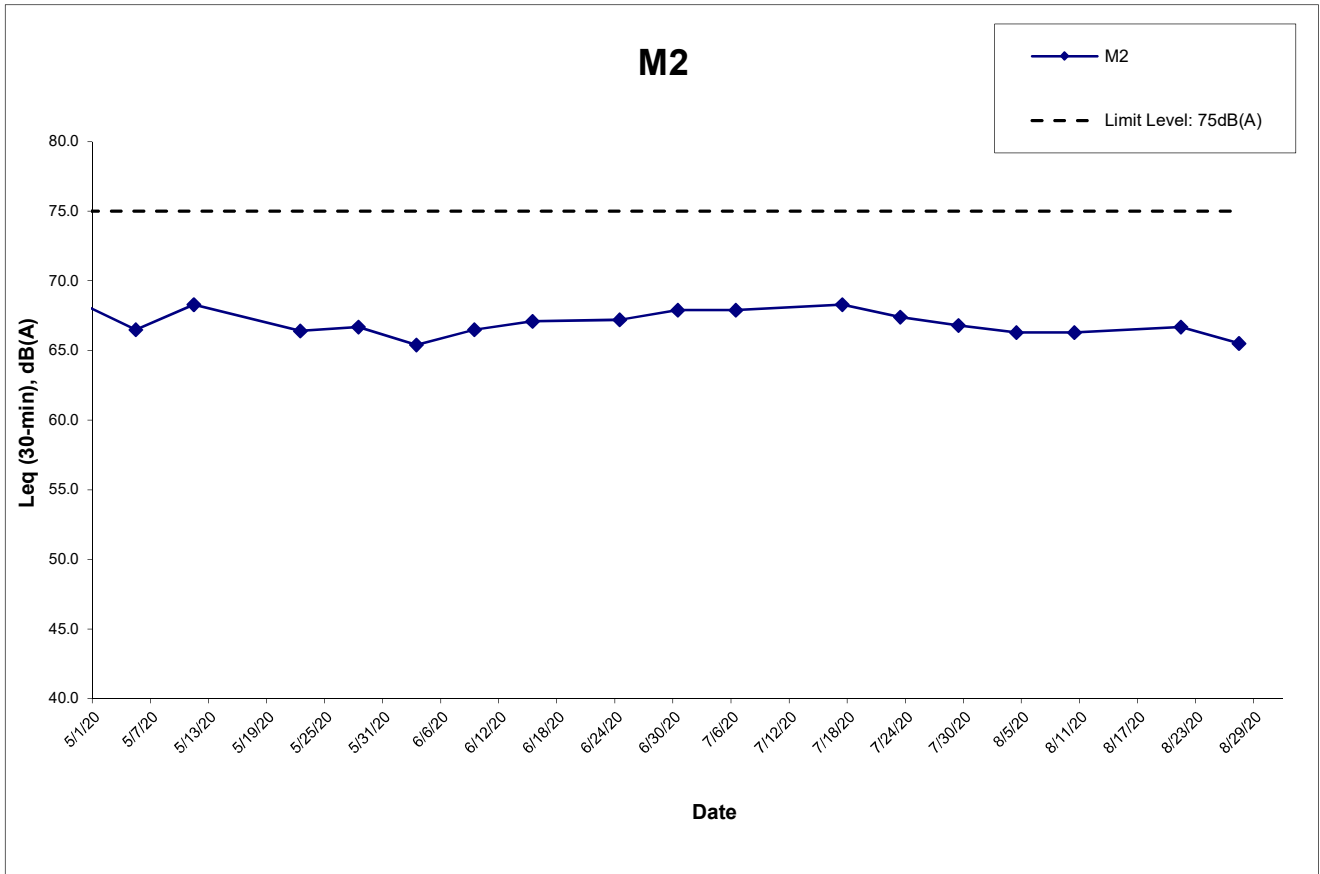

This Drawing has been prepared for the use of AECOM's client. It may not be used, modified, reproduced or relied upon by third parties, except as agreed by AECOM or as required by law. AECOM accepts no responsibility, and denies any liability whatsoever, to any party that uses or relies on this drawing without AECOM's express written consent.

CONTRACT NO. HY/2012/06  
 WIDENING OF FANLING HIGHWAY  
 - TAI HANG TO WO HOP SHEK INTERCHANGE



### Graphical Presentation of Impact Daytime Construction Noise Monitoring Results

Project No.: 60307376

Date: Sep-20

Appendix I



---

---

**APPENDIX J  
EVENT ACTION PLAN**

---

---

## Appendix J – Event Action Plan

### Event / Action Plan for Air Quality

| Event  | Action  |   |   |   |
|--|---|---|---|---|
|  | ET Leader   | IEC   | ER  | Contractor  |
| <b>Action Level</b>                            |   |   |   |   |
| Exceedance for one sample                      | <ol style="list-style-type: none"> <li>1. Identify source;</li> <li>2. Inform IEC and ER;</li> <li>3. Repeat measurement to confirm finding;</li> <li>4. Increase monitoring frequency to daily.</li> </ol>   | <ol style="list-style-type: none"> <li>1. Check monitoring data submitted by ET;</li> <li>2. Check Contractor's working method.</li> </ol>  | <ol style="list-style-type: none"> <li>1. Notify Contractor.</li> </ol>   | <ol style="list-style-type: none"> <li>1. Rectify any unacceptable practice;</li> <li>2. Amend working methods if appropriate.</li> </ol>   |
| Exceedance for two or more consecutive samples | <ol style="list-style-type: none"> <li>1. Identify source;</li> <li>2. Inform IEC and ER;</li> <li>3. Repeat measurements to confirm findings;</li> <li>4. Increase monitoring frequency to daily;</li> <li>5. Discuss with IEC and Contractor on remedial actions required;</li> <li>6. If exceedance continues, arrange meeting with IEC and ER;</li> <li>7. If exceedance stops, cease additional monitoring.</li> </ol> | <ol style="list-style-type: none"> <li>1. Check monitoring data submitted by ET;</li> <li>2. Check Contractor's working method;</li> <li>3. Discuss with ET and Contractor on possible remedial measures;</li> <li>4. Advise the ER on the effectiveness of the proposed remedial measures;</li> <li>5. Supervise Implementation of remedial measures.</li> </ol> | <ol style="list-style-type: none"> <li>1. Confirm receipt of notification of failure in writing;</li> <li>2. Notify Contractor;</li> <li>3. Ensure remedial measures properly implemented.</li> </ol> | <ol style="list-style-type: none"> <li>1. Submit proposals for remedial actions to IEC within 3 working days of notification;</li> <li>2. Implement the agreed proposals;</li> <li>3. Amend proposal if appropriate.</li> </ol> |

Event / Action Plan for Air Quality

| Event<br>Action Level                          | Action  |   |   |   |
|--|---|---|---|---|
|  | ET Leader   | IEC   | ER  | Contractor  |
| <b>Limit Level</b>                             |   |   |   |   |
| Exceedance for one sample                      | <ol style="list-style-type: none"> <li>1. Identify source;</li> <li>2. Inform IEC, ER, Contractor and EPD;</li> <li>3. Repeat measurement to confirm finding;</li> <li>4. Increase monitoring frequency to daily;</li> <li>5. Assess effectiveness of Contractor's remedial actions and keep IEC, EPD and ER informed of the results.</li> </ol>  | <ol style="list-style-type: none"> <li>1. Check monitoring data submitted by ET;</li> <li>2. Check Contractor's working method;</li> <li>3. Discuss with ET and Contractor on possible remedial measures;</li> <li>4. Advise ER on the effectiveness of the proposed remedial measures;</li> <li>5. Supervise implementation of remedial measures.</li> </ol> | <ol style="list-style-type: none"> <li>1. Confirm receipt of notification of exceedance in writing;</li> <li>2. Notify Contractor;</li> <li>3. Ensure remedial measures properly implemented.</li> </ol>  | <ol style="list-style-type: none"> <li>1. Take immediate action to avoid further exceedance;</li> <li>2. Submit proposals for remedial actions to IEC within 3 working days of notification;</li> <li>3. Implement the agreed proposals;</li> <li>4. Amend proposal if appropriate.</li> </ol>  |
| Exceedance for two or more consecutive samples | <ol style="list-style-type: none"> <li>1. Notify IEC, ER, Contractor and EPD;</li> <li>2. Identify source;</li> <li>3. Repeat measurement to confirm findings;</li> <li>4. Increase frequency to daily;</li> <li>5. Analyse Contractor's working procedures to determine possible mitigation to be;</li> <li>6. Arrange meeting with IEC and ER to discuss the remedial actions to be taken;</li> <li>7. Assess effectiveness of Contractor's remedial actions and keep IEC, EPD and ER informed of the results;</li> <li>8. If exceedance stops, cease additional monitoring.</li> </ol> | <ol style="list-style-type: none"> <li>1. Discuss amongst ER, ET, and Contractor on the potential remedial actions;</li> <li>2. Review Contractor's remedial actions whenever necessary to assure their effectiveness and advise ER accordingly;</li> <li>3. Supervise the implementation of remedial measures.</li> </ol>                                    | <ol style="list-style-type: none"> <li>1. Confirm receipt of notification of exceedance in writing;</li> <li>2. Notify Contractor;</li> <li>3. In consultation with the IEC, agree with the Contractor on the remedial measures to be implemented;</li> <li>4. Ensure remedial measures properly implemented;</li> <li>5. If exceedance continues, consider what portion of the work is responsible and instruct the Contractor to stop that portion of work until the exceedance is abated.</li> </ol> | <ol style="list-style-type: none"> <li>1. Take immediate action to avoid further exceedance;</li> <li>2. Submit proposals for remedial actions to IEC within 3 working days of notification;</li> <li>3. Implement the agreed proposals;</li> <li>4. Resubmit proposals if problem still not under control;</li> <li>5. Stop the relevant portion of works as determined by ER until the exceedance is abated.</li> </ol> |

Event / Action Plan for Noise Impact

| Event<br>Limit Level | Action  |  |  |  |
|----------------------|---|--|--|--|
|                      | ET Leader   | IEC  | ER   | Contractor   |
| Action Level         | <ol style="list-style-type: none"> <li>1. Notify IEC and the Contractor.</li> <li>2. Carry out investigation.</li> <li>3. Report the results of investigation to IEC and the Contractor.</li> <li>4. Discuss with the Contractor and formulate remedial measures.</li> <li>5. Increase monitoring frequency to check mitigation effectiveness.</li> </ol>   | <ol style="list-style-type: none"> <li>1. Review with analysed results submitted by ET.</li> <li>2. Review the proposed remedial measures by the Contractor and advise ER accordingly.</li> <li>3. Supervise the implement of remedial measures.</li> </ol>  | <ol style="list-style-type: none"> <li>1. Confirm receipt of notification of failure in writing.</li> <li>2. Notify the Contractor.</li> <li>3. Require the Contractor to propose remedial measures for the analysed noise problem.</li> <li>4. Ensure remedial measures are properly implemented.</li> </ol>  | <ol style="list-style-type: none"> <li>1. Submit noise mitigation proposals to IEC.</li> <li>2. Implement noise mitigation proposals.</li> </ol>   |
| Limit Level          | <ol style="list-style-type: none"> <li>1. Notify, IEC, ER, EPD and the Contractor.</li> <li>2. Identify the source.</li> <li>3. Repeat measurement to confirm findings.</li> <li>4. Increase monitoring frequency.</li> <li>5. Carry out analysis of Contractor's working procedures to determine possible mitigation to be implemented.</li> <li>6. Inform IEC, ER, and EPD the causes &amp; actions taken for the exceedances.</li> <li>7. Assess effectiveness of the Contractor's remedial actions and keep IEC, EPD and ER informed of the results.</li> <li>8. If exceedance stops, cease additional monitoring.</li> </ol> | <ol style="list-style-type: none"> <li>1. Discuss amongst ER, ET Leader and the Contractor on the potential remedial actions.</li> <li>2. Review the Contractor's remedial actions whenever necessary to assure their effectiveness and advise ER accordingly.</li> <li>3. Supervise the implementation of remedial measures.</li> </ol> | <ol style="list-style-type: none"> <li>1. Confirm receipt of notification of failure in writing.</li> <li>2. Notify the Contractor.</li> <li>3. Require the Contractor to propose remedial measures for the analysed noise problem.</li> <li>4. Ensure remedial measures are properly implemented.</li> <li>5. If exceedance continues, consider what activity of the work is responsible and instruct the Contractor to stop that activity of work until the exceedance is abated.</li> </ol> | <ol style="list-style-type: none"> <li>1. Take immediate action to avoid further exceedance.</li> <li>2. Submit proposals for remedial actions to IEC within 3 working days of notification.</li> <li>3. Implement the agreed proposals.</li> <li>4. Resubmit proposals if problem still not under control.</li> <li>5. Stop the relevant activity of works as determined by the ER until the exceedance is abated.</li> </ol> |

---

---

**APPENDIX K  
SITE INSPECTION SUMMARIES**

---

---

**Site Inspection Summary**

*Inspection Information*

|                 |               |
|-----------------|---------------|
| Contract No.    | HY/2012/06    |
| Date:           | 4 August 2020 |
| Time:           | 14:00         |
| Inspection No.: | 348           |

*Non-compliance*

|     |
|-----|
| Nil |
|-----|

*Observations*

|  |   |
|--|---|
|  | <p><u>Follow-up Observation(s)</u></p> <ol style="list-style-type: none"> <li>1. The breaking work at SA324 was completed. (closed)</li> <li>2. The breaker at SA324 was removed. (closed)</li> </ol> <p><u>New Observation (s)</u></p> <ol style="list-style-type: none"> <li>3. Stockpile placed without cover was observed at SA324. The Contractor was advised to cover the stockpile with imperious sheeting.</li> <li>4. Breaking work carried without dust control measure was observed at SA340. The Contractor was advised to provide watering to the dusty work.</li> </ol> |
|--|---|

*Remarks*

|     |
|-----|
| Nil |
|-----|

|             | Name      | Signature | Date          |
|-------------|-----------|-----------|---------------|
| Prepared by | Alex Chan |           | 4 August 2020 |
| Checked by  | Y W Fung  | /         | 4 August 2020 |

### Site Inspection Summary

#### Inspection Information

|                 |                |
|-----------------|----------------|
| Contract No.    | HY/2012/06     |
| Date:           | 11 August 2020 |
| Time:           | 14:00          |
| Inspection No.: | 349            |

#### Non-compliance

|     |
|-----|
| Nil |
|-----|

#### Observations

|    |   |
|----|---|
|    | <u>Follow-up Observation(s)</u>   |
| 1. | Water spraying was provided to the stockpile at SA340. (closed)             |
| 2. | The breaking work at SA340 was completed. (closed)                          |
|    | <u>Reminder (s)</u>   |
| 3. | The Contractor was reminded to clean the silt at outside boundary of SA340. |

#### Remarks

|     |
|-----|
| Nil |
|-----|

|             | Name      | Signature | Date           |
|-------------|-----------|-----------|----------------|
| Prepared by | Alex Chan |           | 11 August 2020 |
| Checked by  | Y W Fung  | /         | 11 August 2020 |

### Site Inspection Summary

#### Inspection Information

|                 |                |
|-----------------|----------------|
| Contract No.    | HY/2012/06     |
| Date:           | 18 August 2020 |
| Time:           | 14:00          |
| Inspection No.: | 350            |

#### Non-compliance

|     |
|-----|
| Nil |
|-----|

#### Observations

|    |   |
|----|---|
|    | <u>Follow-up Observation(s)</u>   |
| 1. | The silt at outside boundary of SA340 was removed. (closed)   |
|    | <u>Observation (s)</u>  |
| 2. | Stockpile stored without cover was observed at SA340. The Contractor was advised to provide imperious sheeting to the stockpile stored on site. |

#### Remarks

|     |
|-----|
| Nil |
|-----|

|             | Name      | Signature | Date           |
|-------------|-----------|-----------|----------------|
| Prepared by | Alex Chan |           | 18 August 2020 |
| Checked by  | Y W Fung  | /         | 18 August 2020 |



**Site Inspection Summary**

*Inspection Information*

|                 |                |
|-----------------|----------------|
| Contract No.    | HY/2012/06     |
| Date:           | 25 August 2020 |
| Time:           | 14:00          |
| Inspection No.: | 351            |

*Non-compliance*

|     |
|-----|
| Nil |
|-----|

*Observations*

|  |  |
|--|--|
|  | <p><u>Follow-up Observation(s)</u></p> <p>1. Imperious sheeting was provided to the stockpile at SA340. (closed)</p> <p><u>Observation (s)</u></p> <p>2. Improper disposal of general refuse and construction waste was observed at SA340. The Contractor was advised to provide sufficient waste collection point and store it properly. The Contractor was also advised to provide onsite waste sorting for the general refuse, construction waste and recyclable material.</p> <p>3. Stockpile stored without cover was observed at SA340. The Contractor was advised to provide imperious sheeting to the stockpile stored on site for dust suppression.</p> <p><u>Reminder (s)</u></p> <p>4. The Contractor was reminded to provide water spraying at exposed area of SA340 regularly.</p> <p>5. The Contractor was reminded to affix the NRMM label on the bulldozer at SA340.</p> |
|--|--|

*Remarks*

|     |
|-----|
| Nil |
|-----|

|             | Name      | Signature | Date           |
|-------------|-----------|-----------|----------------|
| Prepared by | Alex Chan |           | 25 August 2020 |
| Checked by  | Y W Fung  | /         | 25 August 2020 |

---

---

**APPENDIX L  
STATISTICS ON COMPLAINTS,  
NOTIFICATION OF SUMMONS AND  
SUCCESSFUL PROSECUTIONS**

---

---

## Appendix L

### Statistics on Complaints, Notifications of Summons and Successful Prosecutions

#### Contract No. HY/2012/06 – Widening of Fanling Highway – Tai Hang to Wo Hop Shek Interchange

|                                 | Date Received    | Subject  | Status | Total no. followed up by the ET this month | Total no. followed up by the ET since project commencement |
|---------------------------------|------------------|--|--------|--|--|
| <b>Environmental complaints</b> | 19 December 2013 | EPD referred a complaint from Lot no. 116 of Fui Sha Wai at Tai Hang of Tai Po which is concerned about the construction noise and diesel-like smell generated from construction activities nearby which caused nuisance and health problems on 19 December 2013 morning.  | Closed | 0  | 10   |
|                                 | 24 February 2014 | EPD referred an air-and-odour complaint on 24 February 2014. The complainant complained about the construction site located near the bus stop in Fui Sha Wai, Tai Hang, Tai Wo Service Road West. When construction works were carried out, odour, white smoke and dust were generated. The complainant asked for follow-up actions. | Closed |  |  |
|                                 | 23 October 2014  | EPD referred an air complaint on 24 October 2014. A resident complained against the excavation works of Tai Wo Service Road West between Nam Wah Po & Tai Hang Tsuen, which have piled up high stockpiles, causing serious dust nuisance to his house.   | Closed |  |  |

| Date Received    | Subject   | Status | Total no. followed up by the ET this month | Total no. followed up by the ET since project commencement |
|------------------|---|--------|--|--|
|                  | <p>The resident also complained that the stockpiles have not been covered and watered properly. He now requires the EPD to follow up.</p> <p>The location of complaint is near Lamppost Location EB5717.</p>  |        |  |  |
| 31 December 2014 | <p>EPD referred a water complaint on 31 December 2014.</p> <p>The complainant complained about the muddy river outside Tai Hang Village Office on 29 December 2014. It was suspected that the muddy water was discharged from the construction works of the Project.</p> <p>He required the EPD to follow up.</p>   | Closed |  |  |
| 25 March 2015    | <p>EPD referred a water complaint on 25 March 2015.</p> <p>The complainant complained about the generation of the smell of gasoline from the Widening of Fanling Highway construction site on Tai Wo Service Road West, causing serious nuisance to nearby houses.</p> <p>The situation has continued for a few weeks and she asked the EPD to follow up as soon as possible.</p> | Closed |  |  |

| <b>Date Received</b>  | <b>Subject</b>   | <b>Status</b> | <b>Total no. followed up by the ET this month</b> | <b>Total no. followed up by the ET since project commencement</b> |
|---|--|---------------|---|---|
| <p>5 January 2017<br/>(Referred by the Contractor on 13 January 2017)</p> | <p>A complaint was received by the 1823 enquiry and complaint hotline on 5 January 2017. The complaint was referred to the Environmental Team by the Contractor on 13 January 2017.</p> <p>The complainant complained against the dust emission generated by the Widening of Fanling Highway construction site on Tai Wo Service Road West near Tai Hang Village.</p> <p>The complainant also complained that Highway Department did not conduct road surface cleansing, which affects residents' health. He/she now requires the Highway Department to follow up.</p> | <p>Closed</p> |   |   |
| <p>22 May 2017<br/>(Referred by the Contractor on 23 May 2017)</p>        | <p>A complaint was received by the 1823 enquiry and complaint hotline on 22 May 2017. The complaint was referred to the Environmental Team by the Contractor on 23 May 2017.</p> <p>A complainant complained that construction noise was caused by the erection of noise barrier on Tai Wo Service Road West near Tai Hang Village on Sunday(s).</p> <p>The complainant concerned about if any Construction Noise Permit is issued by the Environmental Protection Department.</p>   | <p>Closed</p> |   |   |

| Date Received  | Subject  | Status | Total no. followed up by the ET this month | Total no. followed up by the ET since project commencement |
|--|--|--------|--|--|
| 25 February 2018<br>(Referred by the Contractor on 1 March 2018) | <p>The 1823 enquiry and complaint hotline received a complaint on 25 February 2018. The complaint was referred to the Environmental Team by the Contractor on 1 March 2018.</p> <p>A complainant complained that noise nuisance was caused continuously by road construction works at Fanling Highway near Tai Hang Village during 01:30 to 04:00 on 25 February 2018. The complainant concerned that the nuisance affects residence and asked for follow-up action from the related department.</p>                             | Closed |  |  |
| 28 September 2019<br>(Referred by the EPD on 28 October 2019)    | <p>The EPD received a complaint on 28 October 2019. The complaint was referred to the Environmental Team by the Contractor on 28 October 2019.</p> <p>The complainant was regarded to the use of powered mechanical equipment not in accordance with the conditions stipulated in the Construction Noise Permit (CNP) - GW-RN0602-19 in Pak Wo Road near Fanling Highway on 24 September 2019.</p> <p>The complainant concerned about if any Construction Noise Permit is issued by the Environmental Protection Department.</p> | Closed |  |  |

|                                | <b>Date Received</b>   | <b>Subject</b>  | <b>Status</b> | <b>Total no. followed up by the ET this month</b> | <b>Total no. followed up by the ET since project commencement</b> |
|--------------------------------|--|---|---------------|---|---|
|                                | 28 October 2019<br><br>(Referred by the EPD on 14 November 2019) | The Buildings Department received a complaint on 28 October 2019 through email. The complaint was referred to Environmental Team of HY/2012/06 on 14 November 2019.<br><br>The complainant complained about dust and noise nuisance caused continuously by road construction works at Tai Wo Service Road West. | Closed        |   |   |
| <b>Notification of summons</b> | -  | -   | -             | 0   | 0   |
| <b>Successful Prosecutions</b> | -  | -   | -             | 0   | 0   |

**Contract No. 02/HY/2015 – Provision of Bus-Bus Interchange on Fanling Highway Kowloon Bound**

|                                 | <b>Date Received</b> | <b>Subject</b> | <b>Status</b> | <b>Total no. followed up by the ET this month</b> | <b>Total no. followed up by the ET since project commencement</b> |
|---------------------------------|----------------------|----------------|---------------|---|---|
| <b>Environmental complaints</b> | -                    | -              | -             | 0   | 0   |
| <b>Notification of summons</b>  | -                    | -              | -             | 0   | 0   |
| <b>Successful Prosecutions</b>  | -                    | -              | -             | 0   | 0   |