



**Environmental Protection Department**

Contract No. HY/2012/06

**Widening of Fanling Highway  
– Tai Hang to Wo Hop Shek  
Interchange**

**Monthly EM&A Report  
For November 2014**

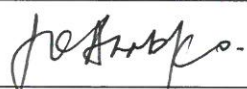
[12/2014]

	Name	Signature
Prepared & Checked:	Joanne Ko	
Reviewed & Approved:	Y W Fung	

Version:	Rev. 0	Date: 9 December 2014
<b>Disclaimer</b>		
<p>This report is prepared for Environmental Protection Department and is given for its sole benefit in relation to and pursuant to Contract No. HY/2012/06 and may not be disclosed to, quoted to or relied upon by any person other than Environmental Protection Department without our prior written consent. No person (other than Environmental Protection Department) into whose possession a copy of this report comes may rely on this report without our express written consent and Environmental Protection Department may not rely on it for any purpose other than as described above.</p>		

<p>AECOM Asia Co. Ltd. 15/F, Grand Central Plaza, Tower 1, 138 Shatin Rural Committee Road, Shatin, NT, Hong Kong Tel: (852) 3922 9000 Fax: (852) 2317 7609 www.aecom.com</p>
---



Our ref AFK/TK/jn/T329380/22.05/L-0052  
T 2828 5919  
E [terence.kong@mottmac.com.hk](mailto:terence.kong@mottmac.com.hk)  
Your ref

Hyder-Arup-Black & Veatch Joint Venture  
c/o Hyder Consulting Limited  
47/F Hopewell Centre  
183 Queen's Road East  
Wanchai, Hong Kong

Dear Sir,

8 December 2014  
By Fax (2805 5028) & Post

**Attn: Mr. James Penny**

**Environmental Monitoring and Audit (EM&A) for Widening of Tolo Highway/Fanling Highway between Island House Interchange and Fanling Stage 2 (between Tai Hang to Wo Hop Shek Interchange) Environmental Permit No. EP-324/2008/B Condition 3.3 – Submission of Monthly EM&A Report – November 2014 for the portion of Stage 2 works under Contract No. HY/2012/06**

We refer to the revised Monthly EM&A Report – November 2014 received on 5 December 2014 submitted by the Environmental Team via email. Pursuant to Environmental Permit Condition 3.3, I hereby verify the Monthly EM&A Report – November 2014 (Rev. 0) for the portion of works under Stage 2 of the captioned Project which is managed under Contract No. HY/2012/06.

Yours faithfully  
for MOTT MACDONALD HONG KONG LIMITED

A handwritten signature in blue ink that reads "Terence Kong".

Terence Kong  
Independent Environmental Checker

c.c. HyD – Mr. Chung Lok Chin / Mr. Tang Man Kai (Fax: 2714 5198)  
AECOM – Mr. Y W Fung (Fax:2891 0305)

## TABLE OF CONTENTS

	Page
EXECUTIVE SUMMARY	3
1 INTRODUCTION	5
1.1 Background	5
1.2 Scope of Report	6
1.3 Project Organization	6
1.4 Summary of Construction Works	6
1.5 Summary of EM&A Programme Requirements	7
2 AIR QUALITY MONITORING	8
2.1 Monitoring Requirements	8
2.2 Monitoring Equipment	8
2.3 Monitoring Locations	8
2.4 Monitoring Parameters and Frequency	8
2.5 Monitoring Methodology	9
2.6 Monitoring Schedule for the Reporting Month	10
2.7 Results and Observations	11
3 NOISE MONITORING	12
3.1 Monitoring Requirements	12
3.2 Monitoring Equipment	12
3.3 Monitoring Locations	12
3.4 Monitoring Parameters and Frequency	12
3.5 Monitoring Methodology	13
3.6 Monitoring Schedule for the Reporting Month	13
3.7 Monitoring Results	13
4 ENVIRONMENTAL SITE INSPECTION AND AUDIT	15
4.1 Site Inspection	15
4.2 Advice on the Solid and Liquid Waste Management Status	15
4.3 Environmental Licenses and Permits	16
4.4 Implementation Status of Environmental Mitigation Measures	18
4.5 Summary of Exceedances of the Environmental Quality Performance Limit	18
4.6 Summary of Complaints, Notification of Summons and Successful Prosecutions	19
5 FUTURE KEY ISSUES	20
5.1 Construction Programme for the Coming Months	20
5.2 Key Issues for the Coming Month	20
5.3 Monitoring Schedule for the Coming Month	20
6 CONCLUSIONS AND RECOMMENDATIONS	21
6.1 Conclusions	21
6.2 Recommendations	21

## List of Tables

Table 1.1	Contact Information of Key Personnel
Table 2.1	Air Quality Monitoring Equipment
Table 2.2	Locations of Impact Air Quality Monitoring Station
Table 2.3	Air Quality Monitoring Parameters, Frequency and Duration
Table 2.4	Summary of 1-hour TSP Monitoring Results in the Reporting Period
Table 2.5	Summary of 24-hour TSP Monitoring Results in the Reporting Period
Table 3.1	Noise Monitoring Equipment
Table 3.2	Locations of Impact Noise Monitoring Stations
Table 3.3	Noise Monitoring Parameters, Frequency and Duration
Table 3.4	Summary of Construction Noise Monitoring Results in the Reporting Period
Table 4.1	Summary of Waste Flow Table
Table 4.2	Summary of Environmental Licensing and Permit Status

## Figures

Figure 1.1	General Project Layout Plan
Figure 1.2a-b	Locations of Monitoring Station
Figure 4.1	Environmental Complaint Handling Procedures

## List of Appendices

Appendix A	Project Organization Structure
Appendix B	Construction Programme
Appendix C	Implementation Schedule of Environmental Mitigation Measures (EMIS)
Appendix D	Summary of Action and Limit Levels
Appendix E	Calibration Certificates of Monitoring Equipments
Appendix F	EM&A Monitoring Schedules
Appendix G	Impact Air Quality Monitoring Results and their Graphical Presentation
Appendix H	Meteorological Data for the Reporting Month
Appendix I	Impact Daytime Construction Noise Monitoring Results and their Graphical Presentation
Appendix J	Event Action Plan
Appendix K	Site Inspection Summaries
Appendix L	Statistics on Complaints, Notifications of Summons and Successful Prosecutions

## EXECUTIVE SUMMARY

The proposed widening of Tolo Highway and Fanling Highway between Island House Interchange and Fanling (the Project) is a Designated Project under the Environmental Impact Assessment Ordinance (Cap. 499) (EIAO). An Environmental Impact Assessment (EIA) Report (the approved EIA Report) together with an Environmental Monitoring and Audit (EM&A) Manual (the approved EM&A Manual) were completed and approved under the EIAO on 14 July 2000 (Register Number: EIA-043/2000).

The objective of the Project “Widening of Tolo Highway / Fanling Highway between Island House Interchange and Fanling” is to widen Tolo Highway and Fanling Highway to dual 4-lane carriageway in order to alleviate the current traffic congestion problems and to cope with the increasing transport demands to and from the urban areas and also cross boundary traffic.

The Project is a designated project and governed by an Environmental Permit (EP-324/2008) issued by the EPD on 23 December 2008. Subsequently, the EPD issued a Variation of Environmental Permit (EP-324/2008/A) (VEP) on 31 January 2012. The VEP (EP-324/2008/B) was subsequently granted on 17 March 2014 which superseded the previous EP (EP-324/2008/A).

The construction works for this Project are delivered in 2 stages i.e. Stage 1 (between Island House Interchange and Tai Hang) and Stage 2 (between Tai Hang and Wo Hop Shek Interchange). Stage 2 would be implemented under two works contracts. Contract No. HY2012/06 “Widening of Fanling Highway – Tai Hang to Wo Hop Shek Interchange” and the entrusted portion to CEDD under Contract No. CV/2012/09 “Liantang/Heung Yuen Wai Boundary Control Point Site Formation and Infrastructure Works – Contract 3”. This report focuses on Contract No. HY2012/06 “Widening of Fanling Highway – Tai Hang to Wo Hop Shek Interchange” in Stage 2 of the Project only.

Pursuant to the EP (EP-324/2008/B) Condition 2.7, the Capture Survey Trip Report for Ma Wat River Northern Meander (Version 2) for the Project was submitted on 24 December 2013 by the Environmental Team (ET) and verified by the Independent Environmental Checker (IEC) on 6 January 2014.

The construction phase of the Contract under the EP and the Environmental Monitoring and Audit (EM&A) programme of the contract commenced on 21 November 2013. The impact environmental monitoring and audit includes air quality and noise monitoring.

This report documents the findings of EM&A works conducted in the period between 1 and 30 November 2014. As informed by the Contractor, construction activities in the reporting period were:

- Site clearance
- Ground investigation
- Tree felling and transplantation
- Piling works
- Pipe laying
- Retaining wall construction
- Noise barrier
- Excavation
- Backfilling
- Drainage
- Temporary bridge construction
- Box culvert construction
- Houses demolition

### Reporting Change

There was no reporting change required in the reporting month.

### **Breaches of Action and Limit Levels for Air Quality**

No exceedance of Action and Limit Level was recorded for 1-hour and 24-hour TSP monitoring in the reporting month.

### **Breaches of Action and Limit Levels for Noise**

No Action or Limit Level exceedance of construction noise was recorded in the reporting month. No noise complaints related to 0700 – 1900 hours on normal weekdays was received and followed by Environmental Team in the reporting month.

### **Complaint, Notification of Summons and Successful Prosecution**

No complaint, notification of summons or successful prosecution was received in the reporting month.

### **Future Key Issues**

Key issues to be considered in the coming month include:

- Properly store and label oils and chemicals on site;
- Chemical, chemical waste and waste management;
- Collection of construction waste should be carried out regularly;
- Properly maintain all drainage facilities and wheel washing facilities on site;
- Exposed slopes should be covered up properly if no temporary work will be conducted;
- Quieter powered mechanical equipment should be used;
- Suppress dust generated from excavation activities and haul road traffic; and
- Tree protective measures for all retained trees should be well maintained.

## 1 INTRODUCTION

### 1.1 Background

- 1.1.1. Tolo Highway and Fanling Highway are the expressways in the North East New Territories (NENT) connecting Sha Tin, Tai Po and Fanling. These highways form a vital part of the strategic Route 9, which links Hong Kong Island to the boundary at Shenzhen. At present, this section of Route 9 is a dual 3-lane carriageway. However, at several major interchanges along this section of Route 9, the highway is a dual-2 lane carriageway only. Severe congestion is a frequent occurrence during the peak periods, particularly in the Kowloon-bound direction.
- 1.1.2. The objective of the Project “Widening of Tolo Highway / Fanling Highway between Island House Interchange and Fanling” is to widen Tolo Highway and Fanling Highway to dual 4-lane carriageway in order to alleviate the current traffic congestion problems and to cope with the increasing transport demands to and from the urban areas and also cross boundary traffic.
- 1.1.3. The Project is a designated project and governed by an Environmental Permit (EP-324/2008) issued by the EPD on 23 December 2008. Subsequently, the EPD issued a Variation of Environmental Permit (EP-324/2008/A) (VEP) on 31 January 2012. The VEP (EP-324/2008/B) was subsequently granted on 17 March 2014 which superseded the previous EP (EP-324/2008/A).
- 1.1.4. The scope of the Project comprises mainly:-
  - (i) Widening of a 5.7 km section of Tolo Highway and 3.0 km section of Fanling Highway between Island House Interchange and Wo Hop Shek Interchange from the existing dual 3-lane to dual 4-lane, including construction of new vehicular bridges;
  - (ii) Widening of interchange sections at Island House Interchange, Tai Po North Interchange, and Lam Kam Road Interchange from dual 2-lane to dual 3-lane, except Sha Tin bound carriageway at Tai Po North Interchange, which is widened from 3-lane to 4-lane, including realignment of various slip roads;
  - (iii) Modification and reconstruction of highways, vehicular bridges, underpasses and footbridges.
- 1.1.5. The construction works for this Project will be delivered in 2 stages i.e. Stage 1 (between Island House Interchange and Tai Hang) and Stage 2 (between Tai Hang and Wo Hop Shek Interchange). Stage 2 would be implemented under two works contracts. Contract No. HY/2012/06 “Widening of Fanling Highway – Tai Hang to Wo Hop Shek Interchange” and the entrusted portion to CEDD under Contract No. CV/2012/09 “Liantang/Heung Yuen Wai Boundary Control Point Site Formation and Infrastructure Works – Contract 3”. This report focuses on Contract No. HY/2012/06 “Widening of Fanling Highway – Tai Hang to Wo Hop Shek Interchange” in Stage 2 of the Project only.
- 1.1.6. Hyder-Arup-Black and Veatch Joint Venture (HABVJV) are appointed by Highways Department (HyD) as the consultants for the design and construction assignment for the Tolo project under Agreement No. CE 58/2000 Supplementary Agreement No. 3 (SA3) (i.e. the Engineer for the Contract).
- 1.1.7. China State Construction Engineering (Hong Kong) Ltd. (CSHK) was commissioned as the Contractor of the Contract.
- 1.1.8. AECOM Asia Co. Ltd. was commissioned by China State Construction Engineering (Hong Kong) Limited as the Environmental Team (ET) to undertake the Environmental Monitoring and Audit (EM&A) works for the Contract and Mott MacDonald Hong Kong Ltd. acts as the Independent Environmental Checker (IEC) for the Contract.
- 1.1.9. The construction phase of the Contract under the EP commenced on 21 November 2013.
- 1.1.10. According to the updated EM&A Manual of Stage 2 of the Project, there is a need of an EM&A programme including air quality and noise monitoring. The EM&A programme for Stage 2 of the Project commenced on 21 November 2013.

## 1.2 Scope of Report

1.2.1 This is the thirteenth monthly EM&A Report under the Contract No. HY/2012/06 “Widening of Fanling Highway – Tai Hang to Wo Hop Shek Interchange. This report presents a summary of the environmental monitoring and audit works, list of activities and mitigation measures proposed by the ET for the Contract in November 2014.

## 1.3 Project Organization

1.3.1 The project organization structure is shown in Appendix A. The key personnel contact names and numbers are summarized in Table 1.1.

**Table 1.1 Contact Information of Key Personnel**

Party	Position	Name	Telephone	Fax
<b>ER</b> (Hyder-Arup-Black & Veatch Joint Venture)	Chief Resident Engineer	Edwin Chung	6115 0818	2638 0950
<b>IEC</b> (Mott MacDonald Hong Kong Limited)	Independent Environmental Checker	Terence Kong	2828 5919	2827 1823
<b>Contractor</b> (China State Construction Engineering (Hong Kong) Limited)	Environmental Officer	Michael Tsang	9277 4956	2672 2501
		C C Chow	9679 6315	2672 2501
<b>ET</b> (AECOM Asia Company Limited)	ET Leader	Y W Fung	3922 9393	3922 9797

## 1.4 Summary of Construction Works

1.4.1 The construction phase for the Contract under the EP commenced on 21 November 2013.

1.4.2 Details of the construction works carried out by the Contractor in this reporting period are listed below:

- Site clearance
- Ground investigation
- Tree felling and transplanted
- Piling works
- Pipe laying
- Retaining wall construction
- Noise barrier
- Excavation
- Backfilling
- Drainage
- Temporary bridge construction
- Box culvert construction



- Houses demolition

1.4.3 The Construction Programme is shown in Appendix B.

1.4.4 The general layout plan of the Project site showing the contract areas is shown in Figure 1.1.

1.4.5 The environmental mitigation measures implementation schedule are presented in Appendix C.

## **1.5 Summary of EM&A Programme Requirements**

1.5.1 The EM&A programme required environmental monitoring for air quality, noise and environmental site inspections for air quality, water quality, noise, waste management, ecology, and landscape and visual impact. The EM&A requirements for each parameter described in the following sections include:-

- All monitoring parameters;
- Monitoring schedules for the reporting month and forthcoming months;
- Action and Limit levels for all environmental parameters;
- Event / Action Plan;
- Environmental mitigation measures, as recommended in the Project EIA study final report; and
- Environmental requirement in contract documents.

## 2 AIR QUALITY MONITORING

### 2.1 Monitoring Requirements

2.1.1 In accordance with the updated EM&A Manual, baseline 1-hour and 24-hour TSP levels at one air quality monitoring station was established. Impact 1-hour TSP monitoring was conducted for at least three times every 6 days, while impact 24-hour TSP monitoring was carried out for at least once every 6 days. The Action and Limit level of the air quality monitoring is provided in Appendix D.

### 2.2 Monitoring Equipment

2.2.1 24-hour TSP air quality monitoring was performed using High Volume Sampler (HVS) located at each designated monitoring station. The HVS meets all the requirements of the updated EM&A Manual. Portable direct reading dust meters were used to carry out the 1-hour TSP monitoring. Brand and model of the equipment is given in Table 2.1.

**Table 2.1 Air Quality Monitoring Equipment**

Equipment	Brand and Model
Portable direct reading dust meter (1-hour TSP)	Sibata Digital Dust Monitor (Model No. LD-3 and LD-3B)
High Volume Sampler (24-hour TSP)	Tisch Total Suspended Particulate Mass Flow Controlled High Volume Air Sampler (Model No. TE-5170)

### 2.3 Monitoring Locations

2.3.1 The monitoring station was set up at the proposed location in accordance with updated EM&A Manual. Table 2.2 describes details of the monitoring station. The locations are shown in Figure 1.2a.

**Table 2.2 Locations of Impact Air Quality Monitoring Station**

Location	Monitoring Station
AM2 (SR2)	Fanling Government Secondary School

### 2.4 Monitoring Parameters and Frequency

2.4.1 Table 2.3 summarizes the monitoring parameters, frequency and duration of impact TSP monitoring.

**Table 2.3 Air Quality Monitoring Parameters and Frequency**

Parameter	Frequency
24-hour TSP	Once every 6 days
1-hour TSP	3 times every 6 days while the highest dust impact was expected

## 2.5 Monitoring Methodology

### 2.5.1 24-hour TSP Monitoring

- (a) The HVS was installed in the vicinity of the air sensitive receivers. The following criteria were considered in the installation of the HVS.
- (i) A horizontal platform with appropriate support to secure the sampler against gusty wind was provided.
  - (ii) The distance between the HVS and any obstacles, such as buildings, was at least twice the height that the obstacle protrudes above the HVS.
  - (iii) A minimum of 2 meters separation from walls, parapets and penthouse for rooftop sampler.
  - (iv) A minimum of 2 meters separation from any supporting structure, measured horizontally.
  - (v) No furnace or incinerator flues nearby.
  - (vi) Airflow around the sampler was unrestricted.
  - (vii) Permission was obtained to set up the samplers and access to the monitoring stations.
  - (viii) A secured supply of electricity was obtained to operate the samplers.
  - (ix) The sampler was located more than 20 meters from any dripline.
  - (x) Any wire fence and gate, required to protect the sampler, did not obstruct the monitoring process.
  - (xi) Flow control accuracy was kept within  $\pm 2.5\%$  deviation over 24-hour sampling period.
- (b) Preparation of Filter Papers
- (i) Glass fibre filters, G810 were labelled and sufficient filters that were clean and without pinholes were selected.
  - (ii) All filters were equilibrated in the conditioning environment for 24 hours before weighing. The conditioning environment temperature was around 25 °C and not variable by more than  $\pm 3$  °C; the relative humidity (RH) was < 50% and not variable by more than  $\pm 5\%$ . A convenient working RH was 40%.
  - (iii) All filter papers were prepared and analysed by ALS Technichem (HK) Pty Ltd., which is a HOKLAS accredited laboratory and has comprehensive quality assurance and quality control programmes.
- (c) Field Monitoring
- (i) The power supply was checked to ensure the HVS works properly.
  - (ii) The filter holder and the area surrounding the filter were cleaned.
  - (iii) The filter holder was removed by loosening the four bolts and a new filter, with stamped number upward, on a supporting screen was aligned carefully.
  - (iv) The filter was properly aligned on the screen so that the gasket formed an airtight seal on the outer edges of the filter.
  - (v) The swing bolts were fastened to hold the filter holder down to the frame. The pressure applied was sufficient to avoid air leakage at the edges.
  - (vi) Then the shelter lid was closed and was secured with the aluminum strip.
  - (vii) The HVS was warmed-up for about 5 minutes to establish run-temperature conditions.
  - (viii) A new flow rate record sheet was set into the flow recorder.
  - (ix) On site temperature and atmospheric pressure readings were taken and the flow rate of the HVS was checked and adjusted at around 1.1 m<sup>3</sup>/min, and complied with the range specified in the updated EM&A Manual (i.e. 0.6-1.7 m<sup>3</sup>/min).
  - (x) The programmable digital timer was set for a sampling period of 24 hrs, and the starting time, weather condition and the filter number were recorded.
  - (xi) The initial elapsed time was recorded.
  - (xii) At the end of sampling, on site temperature and atmospheric pressure readings were taken and the final flow rate of the HVS was checked and recorded.
  - (xiii) The final elapsed time was recorded.

- (xiv) The sampled filter was removed carefully and folded in half length so that only surfaces with collected particulate matter were in contact.
  - (xv) It was then placed in a clean plastic envelope and sealed.
  - (xvi) All monitoring information was recorded on a standard data sheet.
  - (xvii) Filters were then sent to ALS Technichem (HK) Pty Ltd. for analysis.
- (d) Maintenance and Calibration
- (i) The HVS and its accessories were maintained in good working condition, such as replacing motor brushes routinely and checking electrical wiring to ensure a continuous power supply.
  - (ii) 5-point calibration of the HVS was conducted using TE-5025A Calibration Kit prior to the commencement of baseline monitoring. Bi-monthly 5-point calibration of the HVS will be carried out during impact monitoring.
  - (iii) Calibration certificate of the HVSs are provided in Appendix E.

## 2.5.2 1-hour TSP Monitoring

### (a) Measuring Procedures

The measuring procedures of the 1-hour dust meter were in accordance with the Manufacturer's Instruction Manual as follows:-

- (i) Turn the power on.
- (ii) Close the air collecting opening cover.
- (iii) Push the "TIME SETTING" switch to [BG].
- (iv) Push "START/STOP" switch to perform background measurement for 6 seconds.
- (v) Turn the knob at SENSI ADJ position to insert the light scattering plate.
- (vi) Leave the equipment for 1 minute upon "SPAN CHECK" is indicated in the display.
- (vii) Push "START/STOP" switch to perform automatic sensitivity adjustment. This measurement takes 1 minute.
- (viii) Pull out the knob and return it to MEASURE position.
- (ix) Push the "TIME SETTING" switch the time set in the display to 3 hours.
- (x) Lower down the air collection opening cover.
- (xi) Push "START/STOP" switch to start measurement.

### (b) Maintenance and Calibration

- (i) The 1-hour TSP meter was calibrated at 1-year intervals against a continuous particulate TEOM Monitor, Series 1400ab. Calibration certificates of the Laser Dust Monitors are provided in Appendix E.
- (ii) 1-hour validation checking of the TSP meter against HVS is carried out yearly at the air quality monitoring locations.

## 2.6 Monitoring Schedule for the Reporting Month

2.6.1 The schedule for environmental monitoring in November 2014 is provided in Appendix F.

## 2.7 Results and Observations

2.7.1 The monitoring results for 1-hour TSP and 24-hour TSP are summarized in Table 2.4 and 2.5 respectively. Detailed impact air quality monitoring results are presented in Appendix G.

**Table 2.4 Summary of 1-hour TSP Monitoring Results in the Reporting Period**

Location	Average ( $\mu\text{g}/\text{m}^3$ )	Range ( $\mu\text{g}/\text{m}^3$ )	Action Level ( $\mu\text{g}/\text{m}^3$ )	Limit Level ( $\mu\text{g}/\text{m}^3$ )
<b>AM2</b> (Fanling Government Secondary School)	77.9	68.2 – 83.2	317.8	500

**Table 2.5 Summary of 24-hour TSP Monitoring Results in the Reporting Period**

Location	Average ( $\mu\text{g}/\text{m}^3$ )	Range ( $\mu\text{g}/\text{m}^3$ )	Action Level ( $\mu\text{g}/\text{m}^3$ )	Limit Level ( $\mu\text{g}/\text{m}^3$ )
<b>AM2</b> (Fanling Government Secondary School)	41.1	17.7 – 66.8	200.7	260

- 2.7.2 The major dust source during the monitoring was mainly from nearby traffic emission.
- 2.7.3 All 1-hour and 24-hour TSP results were below the Action and Limit Level at all monitoring locations in the reporting month.
- 2.7.4 The event action plan is annexed in Appendix J.
- 2.7.5 Weather information including wind speed and wind direction is annexed in Appendix H. The information was obtained from the Hong Kong Observatory Tai Po and Tai Mei Tuk Automatic Weather Stations.

### 3 NOISE MONITORING

#### 3.1 Monitoring Requirements

3.1.1 In accordance with the EM&A Manual, impact noise monitoring was conducted for at least once per week during the construction phase of the Contract. The Action and Limit level of the noise monitoring is provided in Appendix D.

#### 3.2 Monitoring Equipment

3.2.1 Noise monitoring was performed using sound level meter at each designated monitoring station. The sound level meters deployed comply with the International Electrotechnical Commission Publications (IEC) 651:1979 (Type 1) and 804:1985 (Type 1) specifications. Acoustic calibrator was deployed to check the sound level meters at a known sound pressure level. Brand and model of the equipment is given in Table 3.1.

**Table 3.1 Noise Monitoring Equipment**

Equipment	Brand and Model
Integrated Sound Level Meter	Rion NL-31 & B&K 2238
Acoustic Calibrator	Rion NC-73 & Rion NC-74

#### 3.3 Monitoring Locations

3.3.1 Monitoring stations M2 and M3 were set up at the proposed locations in accordance with updated EM&A Manual. Figure 1.2a-b shows the locations of the monitoring stations. Table 3.2 describes the details of the monitoring stations.

**Table 3.2 Locations of Impact Noise Monitoring Stations**

Monitoring Station	Location	Description
M2	West Tai Wo	1.2m from the ground floor free-field of the Residential
M3	Fanling Government Secondary School	1m from the exterior of the roof top façade of the school

#### 3.4 Monitoring Parameters and Frequency

3.4.1 Table 3.3 summarizes the monitoring parameters, frequency and duration of impact noise monitoring.

**Table 3.3 Noise Monitoring Parameters, Frequency and Duration**

Parameter	Frequency
30-mins measurement at each monitoring station between 0700 and 1900 on normal weekdays. $L_{eq}$ , $L_{10}$ and $L_{90}$ would be recorded.	At least once per week

### 3.5 Monitoring Methodology

#### 3.5.1 Monitoring Procedure

- (a) Façade measurement was made at monitoring station M3, while free-field measurement was made at monitoring station M2.
- (b) The sound level meter was set on a tripod at a height of 1.2 m above the ground for free-field measurements at monitoring station M2.
- (c) The battery condition was checked to ensure the correct functioning of the meter.
- (d) Parameters such as frequency weighting, the time weighting and the measurement time were set as follows:-
  - (i) frequency weighting: A
  - (ii) time weighting: Fast
  - (iii) time measurement:  $L_{eq(30\text{-minutes})}$  during non-restricted hours i.e. 07:00 – 1900 on normal weekdays;  $L_{eq(5\text{-minutes})}$  during restricted hours i.e. 19:00 – 23:00 and 23:00 – 07:00 of normal weekdays, whole day of Sundays and Public Holidays
- (e) Prior to and after each noise measurement, the meter was calibrated using the acoustic calibrator for 94dB(A) at 1000 Hz. If the difference in the calibration level before and after measurement was more than 1 dB(A), the measurement would be considered invalid and repeat of noise measurement would be required after re-calibration or repair of the equipment.
- (f) During the monitoring period, the  $L_{eq}$ ,  $L_{10}$  and  $L_{90}$  were recorded. In addition, site conditions and noise sources were recorded on a standard record sheet.
- (g) Noise measurement was paused during periods of high intrusive noise (e.g. dog barking, helicopter noise) if possible. Observations were recorded when intrusive noise was unavoidable.
- (h) Noise monitoring was cancelled in the presence of fog, rain, wind with a steady speed exceeding 5m/s, or wind with gusts exceeding 10m/s.

#### 3.5.2 Maintenance and Calibration

- (a) The microphone head of the sound level meter was cleaned with soft cloth at regular intervals.
- (b) The meter and calibrator were sent to the supplier or HOKLAS laboratory to check and calibrate at yearly intervals.
- (c) Calibration certificates of the sound level meters and acoustic calibrators are provided in Appendix E.

### 3.6 Monitoring Schedule for the Reporting Month

3.6.1 The schedule for environmental monitoring in November 2014 is provided in Appendix F.

### 3.7 Monitoring Results

3.7.1 The monitoring results for construction noise are summarized in Table 3.4 and the monitoring data is provided in Appendix I.

**Table 3.4 Summary of Construction Noise Monitoring Results in the Reporting Period**

	Average, dB(A), $L_{eq(30\text{ mins})}$	Range, dB(A), $L_{eq(30\text{ mins})}$	Limit Level, dB(A), $L_{eq(30\text{ mins})}$
M2*	68.7	64.7 – 71.2	75
M3#	62.4	60.0 – 63.0	65/70

\*+3dB(A) Façade correction included

# Limit Level of 70dB(A) applies to education institutes while 65dB(A) applies during school examination period.

- 3.7.2 No Action or Limit Level exceedance of construction noise was recorded in the reporting month. No noise complaints related to 0700 – 1900 hours on normal weekdays was received and followed by Environmental Team in the reporting month.
- 3.7.3 Major noise sources during noise monitoring in the reporting month were mainly road traffic noise.
- 3.7.4 The event action plan is annexed in Appendix J.



## **4 ENVIRONMENTAL SITE INSPECTION AND AUDIT**

### **4.1 Site Inspection**

4.1.1 Site Inspections were carried out on a weekly basis to monitor the implementation of proper environmental pollution control and mitigation measures for the Contract. In the reporting month, 4 site inspections were carried out respectively on 4, 13, 18 and 25 November 2014 for the Contract. While no specific observation was recorded, recommendations on remedial actions were given to the Contractor for precautionary purpose.

4.1.2 The environmental site inspections summaries are provided in Appendix K.

4.1.3 Particular observations during the site inspections are described below:

#### ***Air Quality***

4.1.4 Stockpile of dusty materials were observed without dust suppression measures. The Contractor should spray the stockpiles with water or cover them entirely by tarpaulin for dust suppression.

4.1.5 Site area ID1 was observed to be dry. The Contractor was reminded to enhance the water spraying frequency for dust suppression. (Reminder)

4.1.6 The site area of Zone 1 was observed to be dry. The Contractor was reminded to set up watering facilities as soon as possible and enhance the water spraying frequency to suppress dust. (Reminder)

#### ***Noise***

4.1.7 No adverse observation was identified in the reporting month.

#### ***Water Quality***

4.1.8 No adverse observation was identified in the reporting month.

#### ***Chemical and Waste Management***

4.1.9 Stagnant water and general refuse was observed at ID1. The Contractor should clear the stagnant water and refuse to prevent mosquito breeding and maintain good housekeeping.

#### ***Landscape and Visual Impact***

4.1.10 No adverse observation was identified in the reporting month.

#### ***Miscellaneous***

4.1.11 Stagnant water and general refuse was observed at ID1. The Contractor should clear the stagnant water and refuse to prevent mosquito breeding and maintain good housekeeping.

### **4.2 Advice on the Solid and Liquid Waste Management Status**

4.2.1 The Contractor has registered as chemical waste producers for the Contract. C&D material sorting was carried out on site. Sufficient numbers of receptacles were available for general refuse collection.

4.2.2 As advised by the Contractor, 1,596 m<sup>3</sup> of inert C&D material was disposed of as public fill to Tuen Mun 38 (of which 0 m<sup>3</sup> was broken concrete), while 150 m<sup>3</sup> of general refuse was disposed of at NENT landfill. 53 kg of paper/cardboard packaging, 0 kg of plastics and 0 kg of metals were collected by recycling contractors in the reporting month. 554 m<sup>3</sup> of inert C&D materials was reused on site. 840 m<sup>3</sup> of inert C&D materials was reused in other projects. 202 m<sup>3</sup> of inert C&D materials was disposed

of as public fill at NENT. 0 kg of chemical wastes was collected by licensed contractors in the reporting period.

4.2.3 The actual amounts of different types of waste generated by the activities of the Project in the reporting month are shown in Table 4.1.

**Table 4.1 Summary of Waste Flow Table**

Waste Type	Actual Amount	Disposal/Reuse Locations
Inert C&D materials	1,596 m <sup>3</sup> (of which 0 m <sup>3</sup> was broken concrete)	Tuen Mun 38
General refuse	150 m <sup>3</sup>	NENT Landfill
Paper/cardboard packaging	53 kg	Recycling Contractors
Plastics	0 kg	Recycling Contractors
Metals	0 kg	Recycling Contractors
C&D materials reused on site	554 m <sup>3</sup>	Site Area
C&D materials reused in other projects	840 m <sup>3</sup>	Other projects
C&D materials reused in NENT for backfilling	202 m <sup>3</sup>	NENT Landfill
Chemical wastes	0 kg	Licensed Contractors

4.2.4 The Contractor was advised to maintain on site waste sorting and recording system and maximize reuse / recycle of C&D wastes.

### 4.3 Environmental Licenses and Permits

4.3.1 The environmental licenses and permits for Stage 2 of the Project and valid in the reporting month is summarized in Table 4.2.

**Table 4.2 Summary of Environmental Licensing and Permit Status**

Statutory Reference	License/ Permit	License or Permit No.	Valid Period		License/ Permit Holder	Remarks
			From	To		
EIAO	Environmental Permit	EP-324/2008/B	17/03/2014	N/A	HyD	The VEP (EP-324/2008/B) was subsequently granted on 17 March 2014 which superseded the previous EP (EP-324/2008/A).
WPCO	Discharge License (Site)	WT00017159-2013	18/09/2013	30/09/2018	CSHK	--
WDO	Chemical Waste Producer Registration	5213-722-C3822-01	5/09/2013	N/A	CSHK	Chemical waste produced in Contract HY/2012/06
WDO	Billing Account for Disposal of Construction	7009328	08/09/2009	N/A	CSHK	Waste disposal in Contract HY/2008/09

Statutory Reference	License/ Permit	License or Permit No.	Valid Period		License/ Permit Holder	Remarks
			From	To		
	Waste					
NCO	Construction Noise Permit	GW-RN0291-14	09/05/2014	06/11/2014	CSHK	Grouting Works at SA344
		GW-RN0345-14	08/06/2014	16/11/2014	CSHK	Concreting Works at SA320 (South Bound)
		GW-RN0346-14	01/06/2014	02/11/2014	CSHK	Tree Felling at Fanling Highway near Hong Lok Yuen (South Bound)
		GW-RN0356-14	09/06/2014	02/12/2014	CSHK	Zone 2 Dismantling of Sign Gantries (South Bound)
		GW-RN0365-14	15/06/2014	30/11/2014	CSHK	Zone 4 Dismantling of Sign Gantries near Wo Hop Shek Bridge (North Bound)
		GW-RN0462-14	27/07/2014	28/12/2014	CSHK	Zones 1 & 2 Loading and Unloading at Fanling Highway between Yuen Leng and Hong Lok Yuen (South Bound)
		GW-RN0486-14	14/08/2014	31/12/2014	CSHK	Zone 4 Grouting Works at SA340 (South Bound)
		GW-RN0499-14	17/08/2014	28/12/2014	CSHK	Zone 4 Loading and Unloading at Fanling Highway between Ch.23.4 and Ch. 23.8 (North Bound)
		GW-RN0545-14	07/09/2014	28/12/2014	CSHK	Zone 4 Demolition the Bridge Deck of Ho Ka Yuen Footbridge
		GW-RN0547-14	02/09/2014	24/12/2014	CSHK	Zone 4 Demolition the Existing Staircase and Ramp of Ho Ka Yuen Footbridge

Statutory Reference	License/ Permit	License or Permit No.	Valid Period		License/ Permit Holder	Remarks
			From	To		
		GW-RN0582-14	23/09/2014	22/11/2014	CSHK	Zone 1 & 2 Tree Felling (North Bound)
		GW-RN0598-14	24/09/2014	16/01/2015	CSHK	Zone 2 Installation of Catch Fence (Near Yuen Leng)
		GW-RN0635-14	19/10/2014	28/12/2014	CSHK	Zone 4 Demolition the Bridge Deck of Ho Ka Yuen Footbridge
		GW-RN0677-14	09/11/2014	28/12/2014	CSHK	Zone 2 Coring of Road Pavement Samples (South Bound)
		GW-RN0685-14	12/11/2014	17/12/2014	CSHK	Zone 4 Dismantling of High Mast near Jockey Club Road (South Bound)
		GW-RN0687-14	11/11/2014	24/12/2014	CSHK	Zone 1 & 2 Coring of Road Pavement Samples (North Bound)
		GW-RN0711-14	23/11/2014	25/01/2015	CSHK	Zone 2 Coring of Road Pavement Samples (South Bound)

#### 4.4 Implementation Status of Environmental Mitigation Measures

4.4.1 A summary of the Implementation Schedule of Environmental Mitigation Measures (EMIS) is presented in Appendix C.

#### 4.5 Summary of Exceedances of the Environmental Quality Performance Limit

4.5.1 All 1-hour and 24-hour TSP monitoring results complied with the Action / Limit Levels in the reporting period.

4.5.2 No Action or Limit Level exceedance of construction noise was recorded in the reporting month, since no noise complaints related to 0700 – 1900 hours on normal weekdays was received and followed by Environmental Team in the reporting month.

#### **4.6 Summary of Complaints, Notification of Summons and Successful Prosecutions**

- 4.6.1 The Environmental Complaint Handling Procedure is annexed in Figure 4.1.
- 4.6.2 No complaint, notification of summons or successful prosecution was received in the reporting month.
- 4.6.3 Statistics on complaints, notifications of summons and successful prosecutions are summarized in Appendix L.

## **5 FUTURE KEY ISSUES**

### **5.1 Construction Programme for the Coming Months**

5.1.1 The major construction works for the Contract in December 2014 will be:-

- Site clearance
- Ground investigation
- Tree felling and transplantation
- Piling works
- Pipe laying
- Retaining wall construction
- Noise barrier
- Excavation
- Backfilling
- Drainage
- Temporary bridge construction
- Houses demolition
- Box culvert construction
- Soil nail

### **5.2 Key Issues for the Coming Month**

5.2.1 Key issues to be considered in December 2014:-

- Properly store and label oils and chemicals on site;
- Chemical, chemical waste and waste management;
- Collection of construction waste should be carried out regularly;
- Properly maintain all drainage facilities and wheel washing facilities on site;
- Exposed slopes should be covered up properly if no temporary work will be conducted;
- Quieter powered mechanical equipment should be used;
- Suppress dust generated from excavation activities and haul road traffic; and
- Tree protective measures for all retained trees should be well maintained.

### **5.3 Monitoring Schedule for the Coming Month**

5.3.1 The tentative schedule for environmental monitoring in December 2014 is provided in Appendix F.

## **6 CONCLUSIONS AND RECOMMENDATIONS**

### **6.1 Conclusions**

- 6.1.1 The construction phase and EM&A programme of the Contract commenced on 21 November 2013.
- 6.1.2 All 1-hour and 24-hour TSP monitoring results complied with the Action / Limit Levels in the reporting period.
- 6.1.3 No Action or Limit Level exceedance of construction noise was recorded in the reporting month, since no noise complaints related to 0700 – 1900 hours on normal weekdays was received and followed by Environmental Team in the reporting month.
- 6.1.4 4 environmental site inspections were carried out in November 2014. Recommendations on remedial actions were given to the Contractors for the deficiencies identified during the site audits.
- 6.1.5 No complaint, notification of summons or successful prosecution was received in the reporting month.

### **6.2 Recommendations**

- 6.2.1 According to the environmental site inspections performed in the reporting month, the following recommendations on remedial actions were provided to the Contractor for precautionary purpose:

#### ***Air Quality Impact***

- Stockpiles should be sprayed with water or covered entirely by tarpaulin for dust suppression.
- Haul roads should be sufficiently dampened to minimize fugitive dust generation.

#### ***Construction Noise Impact***

- Nil.

#### ***Water Quality Impact***

- Nil.

#### ***Chemical and Waste Management***

- General refuse should be removed regularly to maintain good housekeeping.

#### ***Landscape and Visual Impact***

- Nil.

#### ***Miscellaneous***

- Stagnant water should be cleared to prevent mosquito breeding.

---

---

## FIGURES

---

---



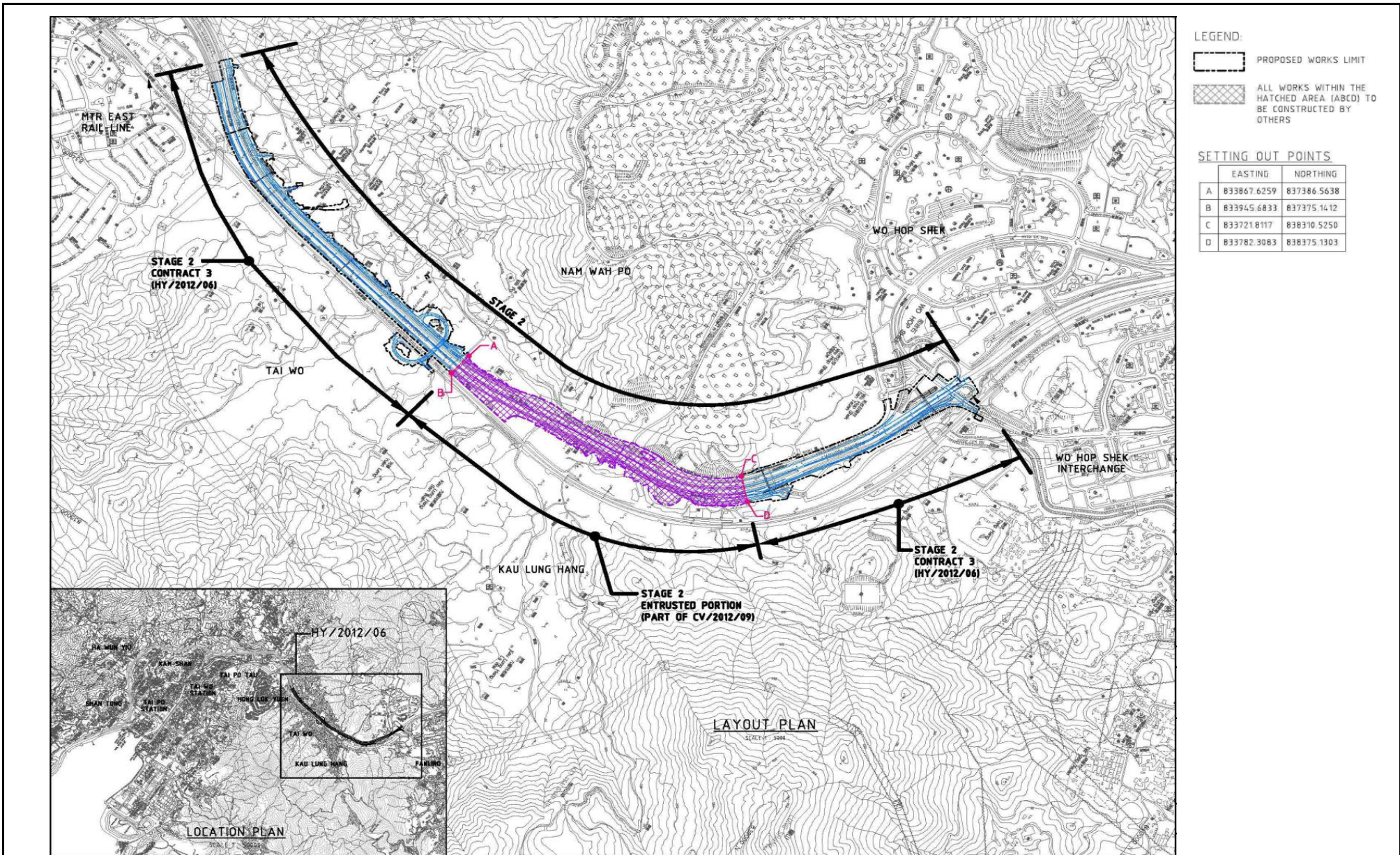

This Drawing has been prepared for the use of AECOM's client. It may not be used, modified, reproduced or relied upon by third parties, except as agreed by AECOM or as required by law. AECOM accepts no responsibility, and denies any liability whatsoever, to any party that uses or relies on this drawing without AECOM's express written consent.

CONTRACT NO. HY/2012/06  
 WIDENING OF FANLING HIGHWAY  
 - TAI HANG TO WO HOP SHEK INTERCHANGE



Layout Plan

Date: Dec 2013

Figure 1.1

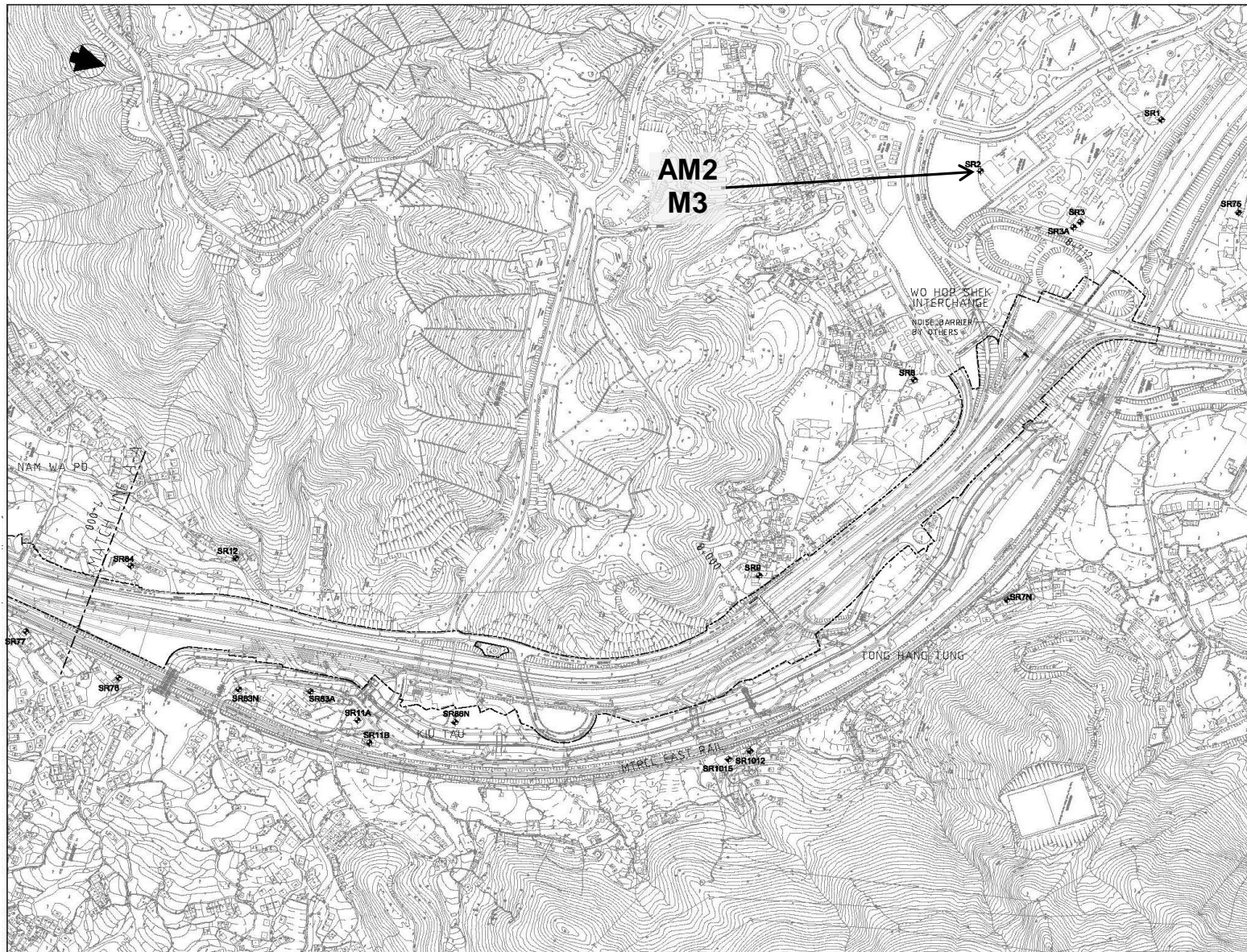

This Drawing has been prepared for the use of AECOM's client. It may not be used, modified, reproduced or relied upon by third parties, except as agreed by AECOM or as required by law. AECOM accepts no responsibility, and denies any liability whatsoever, to any party that uses or relies on this drawing without AECOM's express written consent.

CONTRACT NO. HY/2012/06  
 WIDENING OF FANLING HIGHWAY  
 - TAI HANG TO WO HOP SHEK INTERCHANGE



Locations of Monitoring Station

Date: Dec 2013

Figure 1.2a

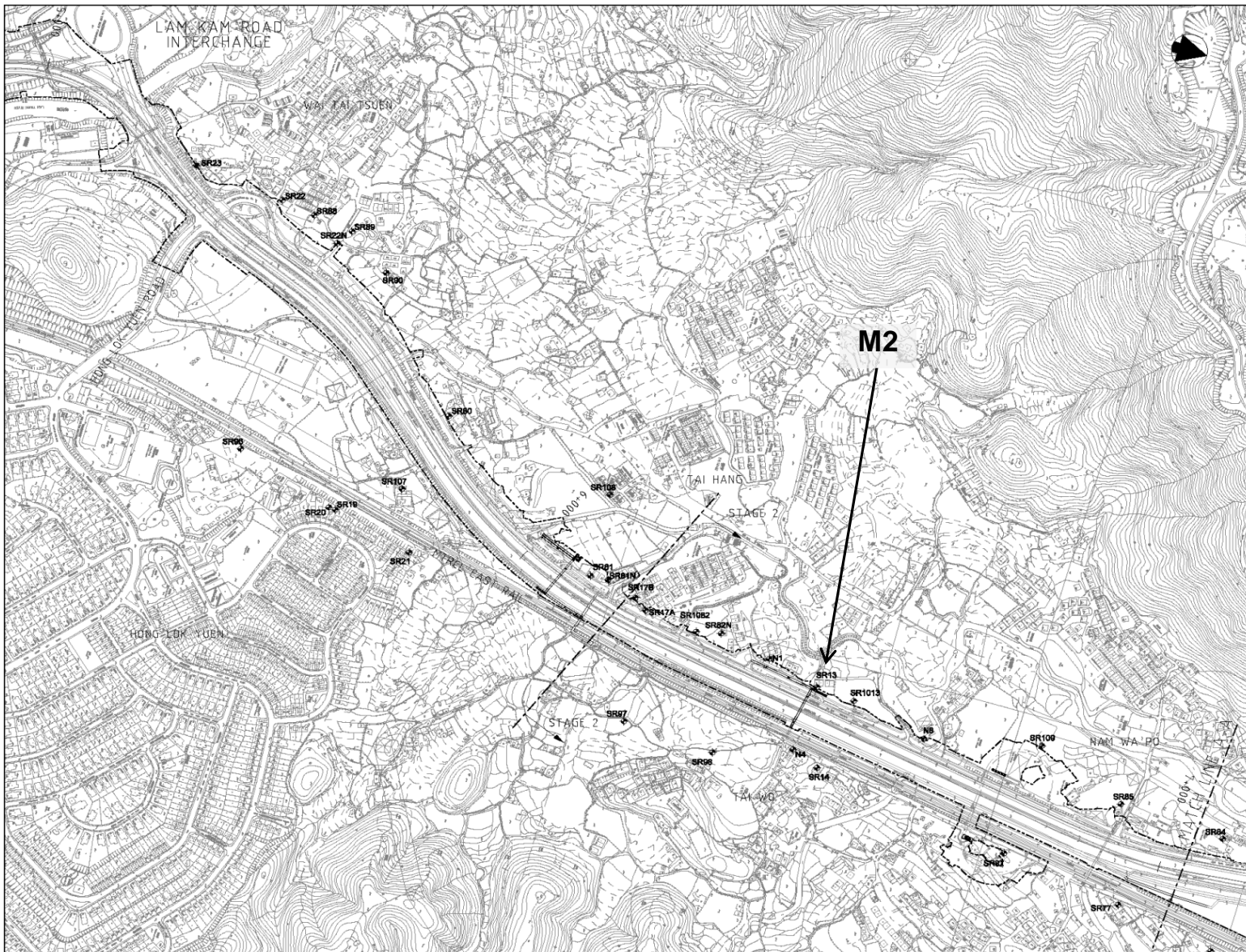

This Drawing has been prepared for the use of AECOM's client. It may not be used, modified, reproduced or relied upon by third parties, except as agreed by AECOM or as required by law. AECOM accepts no responsibility, and denies any liability whatsoever, to any party that uses or relies on this drawing without AECOM's express written consent.

CONTRACT NO. HY/2012/06  
 WIDENING OF FANLING HIGHWAY  
 - TAI HANG TO WO HOP SHEK INTERCHANGE



Locations of Monitoring Station

Date: Dec 2013

Figure 1.2b

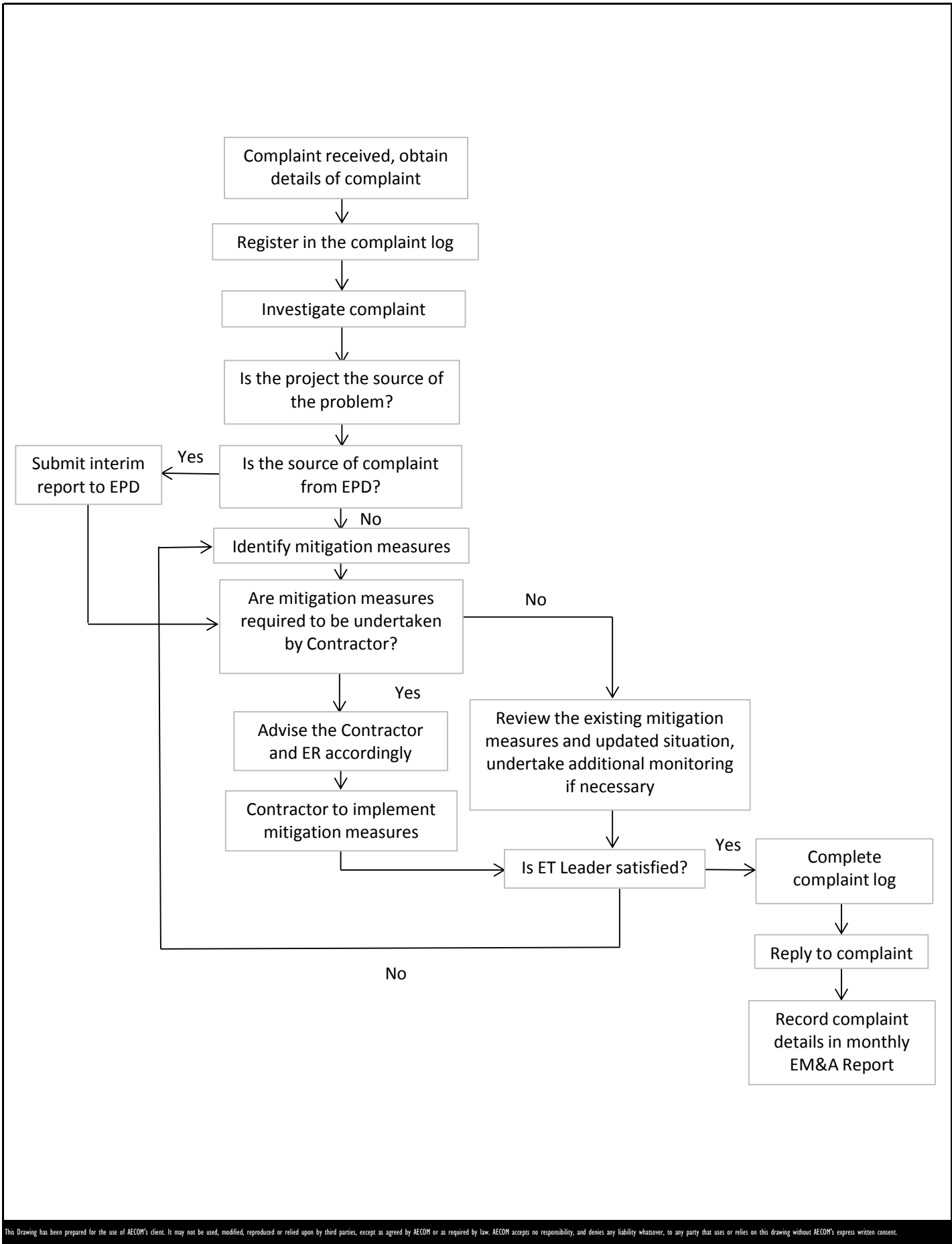

This Drawing has been prepared for the use of AECOM's client. It may not be used, modified, reproduced or relied upon by third parties, except as agreed by AECOM or as required by law. AECOM accepts no responsibility, and denies any liability whatsoever, to any party that uses or relies on this drawing without AECOM's express written consent.

CONTRACT NO. HY/2012/06  
 WIDENING OF FANLING HIGHWAY  
 - TAI HANG TO WO HOP SHEK INTERCHANGE



Environmental Complaint Handling Procedure

---

---

**APPENDIX A  
PROJECT ORGANIZATION STRUCTURE**

---

---

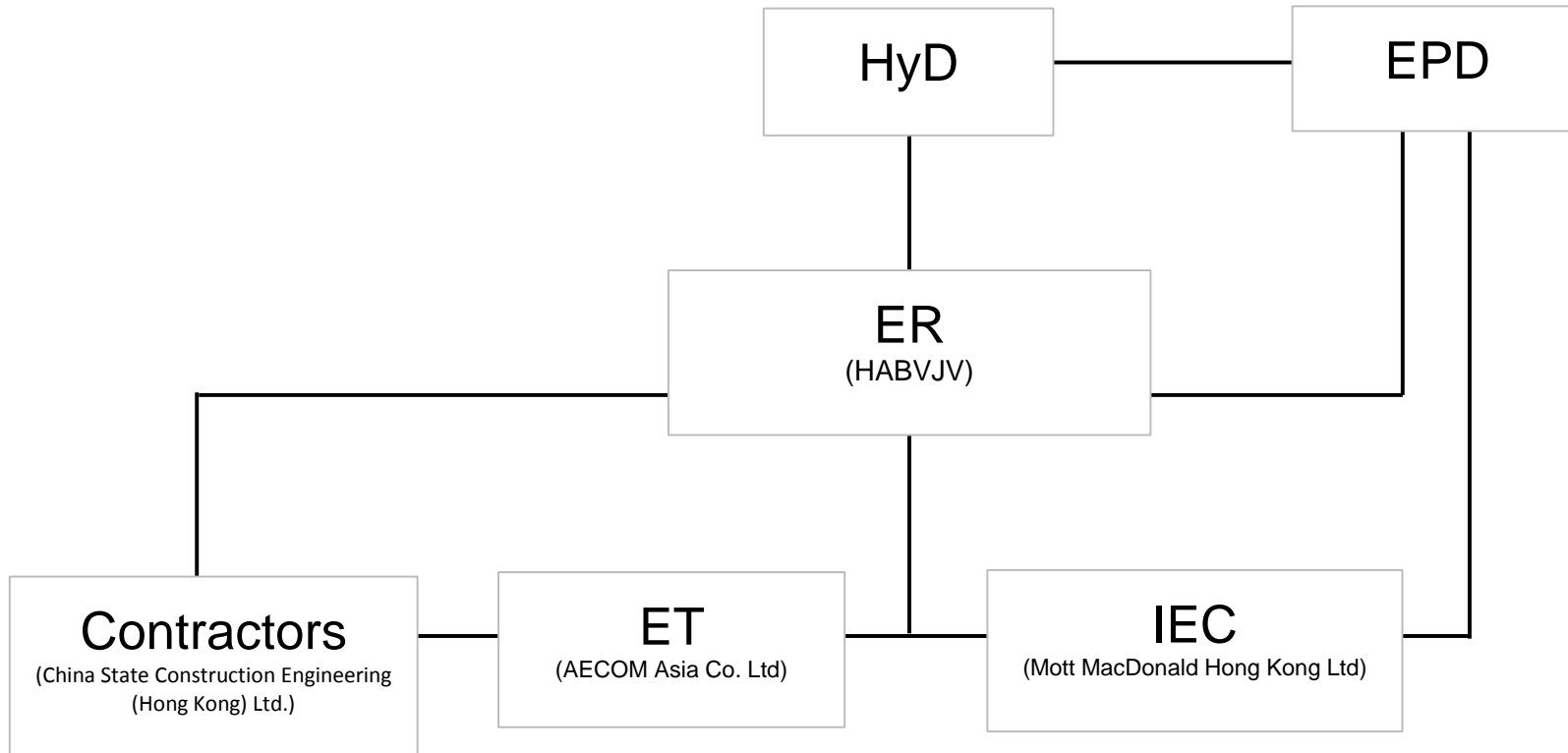

This Drawing has been prepared for the use of AECOM's client. It may not be used, modified, reproduced or relied upon by third parties, except as agreed by AECOM or as required by law. AECOM accepts no responsibility, and denies any liability whatsoever, to any party that uses or relies on this drawing without AECOM's express written consent.

CONTRACT NO. HY/2012/06  
 WIDENING OF FANLING HIGHWAY  
 - TAI HANG TO WO HOP SHEK INTERCHANGE



Project Organization Structure

---

---

**APPENDIX B  
CONSTRUCTION PROGRAMMES**

---

---

Activity ID	Activity Name	Duration % Complete	Remaining Duration	Original Duration	Start	Finish	Total Float	2014				2015							
								Nov	Dec	Jan	Feb	Nov	Dec	Jan	Feb				
<b>Contract Condition</b>																			
<b>General</b>																			
<b>Contract Condition</b>																			
<b>Contract Condition</b>																			
POSSA310	Site Area SA 310 (395d)	0%	0	0	20-Nov-14*		-96												
POSSA320B	Site Area SA320B (0d)	0%	0	0	01-Jan-15*		0												
POSSA321	Site Area SA321 (120d)	0%	0	0	01-Jan-15*		0												
POSSA322A	Site Area SA322A (180d)	0%	0	0	01-Jan-15*		0												
POSSA322B	Site Area SA322B (180d)	0%	0	0	01-Jan-15*		0												
POSSA323	Site Area SA323 (360d)	0%	0	0	20-Nov-14*		-51												
POSSA323A	Site Area SA323A (360d) (not required)	0%	0	0	20-Nov-14*		-130												
POSSA327	Site Area SA327 (180d)	0%	0	0	01-Jan-15*		0												
<b>Partial Possession Status</b>																			
<b>Contract Condition</b>																			
<b>Contract Condition</b>																			
POSSA320-180	SA320/326	0%	0	0	20-Nov-14		-184												
<b>ZONE 1 (Ch. 5640 to 5880)</b>																			
<b>Noise Barrier Along TWSR-West and Laying New Utilities</b>																			
<b>Site Clearance &amp; Demolition of Existing Structure</b>																			
<b>General</b>																			
ADVZ10100	Site clearance (Additional Transplant - pending for VO)	6.67%	28	30	30-May-14 A	22-Dec-14	-18												
<b>NB42 (Ch.5640-5740)-TWSR West Side</b>																			
<b>Noise Barrier Works</b>																			
NB00110	NB42 (Ch5640-5740) - Footing & Wall Structure	0%	45	45	20-Jan-15	20-Mar-15	60												
<b>DSD Southern Trunk Sewer, Water Main Fire Main Works</b>																			
TSZ10100	Sheet Piling & Excavation (~5m below ground) (along NB42)	0%	21	21	23-Dec-14	19-Jan-15	45												
TSZ10130	Watermain installation (along NB42)	0%	30	30	20-Jan-15	03-Mar-15	45												
<b>NB42A (Ch.5750-5810)-TWSR West Side</b>																			
<b>Noise Barrier Works</b>																			
NB00190	NB42A (Ch5750-5810) - Footing & Wall Structure	0%	30	30	16-Jan-15	27-Feb-15	-18												
<b>DSD Southern Trunk Sewer, Water Main Fire Main Works</b>																			
TSZ10150	Sheet Piling & Excavation (~5m below ground) (along NB42A)	0%	18	18	23-Dec-14	15-Jan-15	-18												
<b>ZONE 2 (Ch. 5880 to 6930)</b>																			
<b>Noise Barrier Along TWSR-West and Laying New Utilities</b>																			
<b>Site Clearance &amp; Demolition of Existing Structure</b>																			
<b>Demolition Work</b>																			
Z2.P2N.1245	Method statement submission/ approval	80%	12	60	24-Jul-14 A	03-Dec-14	994												
Z2.P2N.1250	Construction of proposed SHRINE	0%	165	165	04-Dec-14	03-Jul-15	994												
<b>NB47 (Ch.5880-5930)-TWSR West Side</b>																			
<b>DSD Southern Trunk Sewer, Water Main Fire Main Works</b>																			
TSZ10250	Sheet Piling & Excavation (~6m below ground) (along NB47)	0%	18	18	02-Jan-15	22-Jan-15	-317												
TSZ10260	DSD Trunk Sewer laying (along NB47)	0%	18	18	23-Jan-15	12-Feb-15	-317												
TSZ10270	Backfill up to NB47 footing level	0%	16	16	13-Feb-15	11-Mar-15	-317												
<b>NB48 (Ch.5995-6120)-TWSR West Side</b>																			
<b>Noise Barrier Works</b>																			
NB00415	NB48 (NB48/5-10) Pre-drilling	0%	64	64	02-Jan-15	25-Mar-15	-91												
<b>DSD Southern Trunk Sewer, Water Main Fire Main Works</b>																			
TSZ10400	Sheet Piling & Excavation (~5m below ground) (along NB48, 0-60m)	0%	21	21	20-Nov-14	13-Dec-14	-72												
TSZ10410	DSD Trunk Sewer laying (along NB48, 0-60m)	0%	18	18	15-Dec-14	07-Jan-15	-72												
TSZ10420	Backfill up to NB48, 0-60m footing level	0%	32	32	08-Jan-15	13-Feb-15	-72												
TSZ10430	Watermain installation (along NB48, 0-60m)	0%	30	30	14-Feb-15	28-Mar-15	-62												
<b>NB49 (Ch.6145-6215)-TWSR West Side</b>																			
<b>Noise Barrier Works</b>																			
NB00485	NB49 - Pre-drilling	34%	33	50	03-Nov-14 A	30-Dec-14	-31												
<b>NB54 (Ch.6240-6280)-TWSR West Side</b>																			
<b>Noise Barrier Works</b>																			
NB00605	NB54 - ID2-1 Pre-drilling (Deleted notified on 14-5, VO issued)	0%	0	0	20-Nov-14	20-Nov-14	-51												
NB00665	NB54 -Pre-drilling	0%	24	24	15-Nov-14 A	17-Dec-14	-75												
<b>NB54A (Ch.6290-6350)-TWSR West Side</b>																			
<b>Noise Barrier Works</b>																			
NB00730	NB54A -Pre-drilling	41.67%	21	36	26-Feb-14 A	13-Dec-14	-2												
NB00740	NB54A piling (0.19m -72no)	6.48%	101	108	05-May-14 A	28-Mar-15	-22												
<b>NB57 (Ch.6365-6445)-TWSR West Side</b>																			
<b>DSD Southern Trunk Sewer, Water Main Fire Main Works</b>																			
TSZ10700	Sheet Piling & Excavation (~5m below ground) (along NB57)	0%	21	21	20-Nov-14	13-Dec-14	-81												
TSZ10710	DSD Trunk Sewer laying (along NB57)	0%	18	18	15-Dec-14	07-Jan-15	-81												
TSZ10720	Backfill up to NB57 footing level	0%	20	20	08-Jan-15	30-Jan-15	-81												
TSZ10730	Watermain installation (along NB57)	0%	30	30	31-Jan-15	14-Mar-15	-39												
<b>NB58 (Ch.6445-6480)-TWSR West Side</b>																			
<b>Noise Barrier Works</b>																			
NB00875	Pending for RSS revised detail of NB58 - piling	0%	14	14	03-Sep-14 A	05-Dec-14	1907												
<b>NB59 (Ch.6490-6590)-TWSR West Side</b>																			

Project ID: DWP Rev 01 (1411)  
 Layout: 3 Month Rolling Program  
 Page 1 of 4

**Contract No. HY/2012/06**  
**Widening of Fanling Highway - Tai Hang to Wo Hop Shek Interchange**  
**3 Month Rolling Program(20-Nov-14)**



Date	Revision	C.	App...
22-Jan-14	IWP Rev 4		
26-Feb-14	IWP Rev 5		
13-May...	WP Rev 1		
30-Jun-14	WP Rev...		



Activity ID	Activity Name	Duration % Complete	Remaining Duration	Original Duration	Start	Finish	Total Float	2014				2015			
								Nov	Dec	Jan	Feb	Nov	Dec	Jan	Feb
<b>Noise Barrier Works</b>															
NB00950	NB59 - piling (0.19m-94no)	0%	144	144	20-Nov-14	22-May-15	-184								
<b>NB63 (Ch.6610-6700)-TWSR West Side</b>															
<b>Noise Barrier Works</b>															
NB01020	NB63 - Footing & Wall Structure	43.33%	34	60	23-Jun-14 A	31-Dec-14	-201								
NB01040	NB63 - NB production	0%	45	45	01-Jan-15	14-Feb-15	1366								
NB4560	NB63 - ID3-1 Footing & Wall Structure	66.67%	20	60	14-Jun-14 A	12-Dec-14	-187								
<b>DSD Southern Trunk Sewer, Water Main Fire Main Works</b>															
TSZ10300	Sheet Piling & Excavation (~7m below ground) (along NB63)	0%	12	12	02-Jan-15	15-Jan-15	-201								
TSZ10310	DSD Trunk Sewer laying (along NB63)	0%	18	18	16-Jan-15	05-Feb-15	-201								
TSZ10330	Watermain installation (along NB63)	0%	30	30	06-Feb-15	20-Mar-15	-201								
<b>DSD Southern Trunk Sewer - Trenchless Construction</b>															
TSZ10950	Construct Pipe jacking pits	0%	60	60	16-Jan-15	07-Apr-15	-39								
<b>Box Culvert Extension ID1</b>															
<b>Structure Works</b>															
ID1-0100	Box Culvert Extension ID1 structure	13.56%	102	118	20-Oct-14 A	30-Mar-15	-118								
<b>Box Culvert Extension ID2</b>															
<b>Structure Works</b>															
ID2-0100	Box Culvert Extension ID2 structure	13.56%	102	118	20-Oct-14 A	30-Mar-15	-118								
<b>Bridge Construction</b>															
<b>New Tai Hang Footbridge</b>															
<b>General</b>															
THBF0330	Structure steel Shop drawing submission (THFB)	0%	60	60	20-Nov-14	31-Jan-15	545								
THBF0335	Structure steel Shop drawing approval (THFB)	0%	30	30	15-Jan-15	18-Feb-15	545								
THBF0340	Structure steel procurement (THFB)	0%	150	150	19-Feb-15	18-Jul-15	685								
<b>TWSR-West/ FL Highway N/B Side Section</b>															
THBF0120	THP5 - Pre-bored H pile (8 nos)	0%	24	24	04-Dec-14	03-Jan-15	-155								
THBF0130	THP5 - Pile Test	0%	28	28	03-Jan-15	31-Jan-15	921								
THBF0140	THP5 - Pile cap, Pier and Pier Head	0%	45	45	19-Jan-15	19-Mar-15	732								
THBF0160	THP8, THP9 - Pre-bored H pile (8 nos)	0%	24	24	05-Jan-15	31-Jan-15	-155								
THBF0170	THP8, THP9 - Pile Test	0%	28	28	31-Jan-15	28-Feb-15	1019								
THBF0180	THP8, THP9 - Pile cap, Pier and Pier Head	0%	30	30	16-Feb-15	30-Mar-15	813								
THBF0200	THAB3 - Pre-bored H pile (4 nos)	0%	12	12	20-Nov-14	03-Dec-14	-155								
THBF0210	THAB3 - Pile Test	0%	28	28	04-Dec-14	31-Dec-14	1047								
THBF0220	THAB3 - pile cap & abutment wall	0%	30	30	18-Dec-14	24-Jan-15	834								
THBF0230	THAB3 - Backfilling (~4m)	0%	27	27	26-Jan-15	05-Mar-15	834								
THBF0290	THAB2 - Pre-bored H pile (18 nos)	0%	54	54	02-Feb-15	16-Apr-15	-155								
<b>TWSR-East FL Highway S/B Side Section</b>															
THBF0440	THAB1 - Predrilling	0%	12	12	20-Nov-14	03-Dec-14	670								
THBF0490	THP2 - Predrilling	0%	12	12	04-Dec-14	17-Dec-14	670								
THBF0700	THP3 - Predrilling	0%	6	6	18-Dec-14	24-Dec-14	688								
THBF0740	THP4 - Predrilling	0%	6	6	27-Dec-14	03-Jan-15	698								
<b>New Tai Wo Footbridge</b>															
<b>General</b>															
TWFB1020	Structure steel Shop drawing submission (TWFB)	0%	90	90	20-Nov-14	16-Mar-15	766								
<b>TWSR-West/ FL Highway N/B Side Section</b>															
TWFB1280	TWP4, TWP5 - Pre-bored H pile (14 nos)	0%	42	42	26-Jan-15	23-Mar-15	-100								
TWFB1320	TWAB1 - Pre-bored H pile (18 nos)	0%	54	54	20-Nov-14	24-Jan-15	-117								
TWFB1330	TWAB1 - Pile Test	0%	28	28	24-Jan-15	21-Feb-15	-143								
TWFB1340	TWAB1 - pile cap & abutment wall	0%	30	30	09-Feb-15	23-Mar-15	-118								
<b>Temporary Tai Wo Footbridge</b>															
<b>Design Works</b>															
TWFB-T1010	Design preparation	0%	90	90	20-Nov-14	16-Mar-15	197								
<b>Demolition of Existing Tai Wo Footbridge</b>															
<b>TWSR-West/ FL Highway N/B Side Section</b>															
TWFB-DE0900	Site Clearance	0%	30	30	01-Nov-14 A	24-Dec-14	584								
<b>Noise Barrier Along Fanling Highway S/B</b>															
<b>NB51 (Ch.5935-6055)-FH S/B Side</b>															
<b>Noise Barrier Works</b>															
NB02270	NB51 ID1-3 (0-25m) - Sheet piling & Excavation	0%	21	21	20-Nov-14	13-Dec-14	332								
NB02280	NB51 ID1-3 (0-25m) - Footing & Wall Structure	0%	90	90	15-Dec-14	13-Apr-15	332								
<b>NB61 (Ch.6400-6560)-FH S/B Side (MTRC I&amp;P Area)</b>															
<b>Noise Barrier Works</b>															
NB02830	NB61 (50-160m) - Footing & Wall Structure	0%	80	80	19-Jul-14 A	04-Mar-15	141								
<b>NB61A (Ch.6560-6745)-FH S/B Side (MTRC I&amp;P Area)</b>															
<b>Noise Barrier Works</b>															
NB02960	NB61A ID2-3 (50-75m) - Sheet piling & Excavation	0%	10	10	20-Nov-14	01-Dec-14	932								
NB02970	NB61A ID2-3 (50-75m) - Footing & Wall Structure	0%	70	70	02-Dec-14	04-Mar-15	932								
NB03040	NB61A (75-190m) - NB production	0%	45	45	20-Nov-14	03-Jan-15	1408								
NB03050	NB61A (75-190m) - NB post & panel installation	0%	5	5	05-Jan-15	09-Jan-15	1130								
<b>Other Works</b>															
<b>Site Clearance &amp; Demolition of Existing Structure</b>															
<b>Contract Condition</b>															
MCLT1040	Engineer approval	0%	12	12	16-Sep-14 A	03-Dec-14	-106								
MCLT1050	Apply cert for exemption by DLO by Engineer	0%	12	12	04-Dec-14	17-Dec-14	-106								
MCLT1060	Design available for construction	0%	0	0		17-Dec-14	-106								

17-Dec-14 ♦ Design available for construction

Activity ID	Activity Name	Duration % Complete	Remaining Duration	Original Duration	Start	Finish	Total Float	2014				2015					
								Nov	Dec	Jan	Feb	Nov	Dec	Jan	Feb		
MCLT1070	Method Statement submission & Demolish House for New MCLT	0%	40	40	20-Nov-14	08-Jan-15	1881										
MCLT1080	Construct New MCLT (Structure)	0%	60	60	18-Dec-14	09-Mar-15	-106										
<b>General</b>																	
Z2.P2N.1010	Submission of contractor's design for site formation	0%	28	28	13-Dec-14	17-Jan-15	-277										
Z2.P2N.1050	Temporary access road construction	0%	21	21	02-Jan-15	26-Jan-15	-277										
Z2.P2N.1060	Site clearance	0%	10	10	02-Jan-15	13-Jan-15	-277										
Z2.P2N.1070	SA322A: Tree Removal Works	0%	14	14	14-Jan-15	29-Jan-15	-277										
Z2.P2N.1080	Site formation works (Demolition of existing villiage houses with log no.	0%	50	50	19-Jan-15	25-Mar-15	-277										
<b>South Buffer Zone 1 (SBZ1) (within Zone 2)(Ch.6740 to 6930)</b>																	
<b>Noise Barrier Along TWSR-West and Laying New Utilities</b>																	
<b>NB63A (Ch.6710-6840)-TWSR West Side</b>																	
<b>Noise Barrier Works</b>																	
NB01090	NB63A-1 - NB production	0%	45	45	20-Nov-14	03-Jan-15	768										
NB01120	NB63A-2 - Footing & Wall Structure (ch10.7-24.2)	0%	30	30	20-Nov-14	24-Dec-14	73										
NB01140	NB63A-2 - NB production	0%	45	45	25-Dec-14	07-Feb-15	733										
NB01170	NB63A-3 - Footing & Wall Structure (ch24.2-86.9)	0%	50	50	27-Dec-14	04-Mar-15	73										
<b>NB64 &amp; NB64A (Ch.6860-6920)-TWSR West Side</b>																	
<b>Noise Barrier Works</b>																	
NB001010	NB64 & NB64A -piling (0.19m -78no)	0%	90	90	17-Nov-14 A	16-Mar-15	-172										
<b>Bridge Construction</b>																	
<b>Kau Lung Hang Vehicular Bridge</b>																	
<b>KLH Bridge - West Ramp</b>																	
Z2.KLH.1002	West Abutment- Pile cap & Structural Wall	0%	90	90	20-Nov-14	16-Mar-15	-59										
<b>KLH Bridge - Deck 1</b>																	
Z2.KLH.1012	Pier VBP1- Pile testing	0%	28	28	20-Nov-14	22-Dec-14	53										
Z2.KLH.1018	Pier VBP2- Pre-bored H-pile piling works (8 Nos.)	0%	24	24	20-Nov-14 A	17-Dec-14	129										
Z2.KLH.1020	Pier VBP2- Pile testing	0%	28	28	18-Dec-14	22-Jan-15	129										
<b>KLH Bridge - Ramp R1</b>																	
Z2.KLH.1440	Ramp R1 - Pre-bored H-pile piling works (R1P1-P3) (9 Nos.)	70.37%	8	27	30-Sep-14 A	28-Nov-14	232										
Z2.KLH.1450	Ramp R1 - Pile caps and pier construction (R1P1)	0%	40	40	29-Nov-14	17-Jan-15	232										
Z2.KLH.1660	Ramp R1 - Pile caps and pier construction (R1P2)	0%	40	40	19-Jan-15	13-Mar-15	232										
Z2.KLH.1710	Ramp R1 - Abutment R1 - base slab & wall	0%	45	45	20-Nov-14	14-Jan-15	285										
Z2.KLH.1720	Ramp R1 - Abutment R1 - Top slab	0%	30	30	15-Jan-15	18-Feb-15	285										
<b>KLH Bridge - Deck 3</b>																	
Z2.KLH.1350	VBP6 - Pre-bored H-pile piling works (12 Nos.)	0%	60	60	20-Nov-14	31-Jan-15	-75										
Z2.KLH.1360	VBP6 - Pile cap, pier construction	0%	90	90	02-Feb-15	30-May-15	-75										
Z2.KLH.1810	East Abutment - Pile caps, abutment wall construction	36%	48	75	20-Oct-14 A	17-Jan-15	-63										
Z2.KLH.1890	VBP8 - Pile caps, pier and pier head construction	0%	75	75	19-Jan-15	27-Apr-15	-63										
<b>KLH Bridge - Deck 2</b>																	
Z2.KLH.1142	Deck 2 precast concrete beam Shop drawing submission & approval	0%	150	150	20-Nov-14	18-Apr-15	60										
Z2.KLH.1220	VBP5- Pile cap, pier, pier head construction	0%	80	80	20-Nov-14	04-Mar-15	7										
<b>KLH Bridge - Ramp R2</b>																	
Z2.KLH.1520	Ramp R2 - Pre-bored H-pile piling works (18 Nos.)	38.89%	33	54	27-Jun-14 A	02-Jan-15	88										
Z2.KLH.1530	Ramp R2 - Pile cap, abutment and pier construction	0%	120	120	30-Dec-14	02-Jun-15	88										
Z2.KLH.1590	Land Possession for House 190B	0%	0	0		20-Nov-14	-41										
20-Nov-14* ♦ Land Possession for House 190B																	
<b>Demolition of Existing Nam Wa Po Footbridge</b>																	
<b>General</b>																	
Z2.NWP.0500	Site Clearance	0%	26	20	29-Aug-14 A	19-Dec-14	-164										
Z2.NWP.1000	Modification of Existing Planter for Pier of Temporary Footbridge	0%	25	25	20-Dec-14	21-Jan-15	-164										
Z2.NWP.1010	Removal of Existing Staircase Portion	0%	26	26	22-Jan-15	28-Feb-15	-164										
<b>North Buffer Zone 2 (NBZ2) (within Zone 4) (Ch. 7925 to 8100)</b>																	
<b>Site Formation</b>																	
<b>Site Formation Works</b>																	
<b>Site Formation Work</b>																	
Z4SF1070	Backfilling (~20000m3)	70.56%	53	180	10-May-14 A	02-Feb-15	-142										
<b>Retaining Wall W76</b>																	
<b>Structure Works</b>																	
RW761085	Wall construction - W76 (~7m high)	0%	46	40	03-Oct-14 A	15-Jan-15	-142										
Z4SF1090	Watermains installation	0%	21	21	03-Feb-15	06-Mar-15	-142										
Z4SF1100	Firemain installation	0%	21	21	03-Feb-15	06-Mar-15	-142										
<b>Bridge Construction</b>																	
<b>New Ho Ka Yuen Footbridge</b>																	
<b>General</b>																	
HKY1040	Structure steel Shop drawing approval (HKYB)	86.67%	4	30	25-Aug-14 A	24-Nov-14	-163										
HKY1050	Structure steel procurement (HKYB)	0%	150	150	25-Nov-14	23-Apr-15	-196										
<b>TWSR-West/ FL Highway N/B Side Section</b>																	
HKY1135	Soil nail works	0%	50	50	20-Nov-14	20-Jan-15	-146										
HKY1150	HKYP6 - Pre-bored H pile (8 nos)	0%	24	24	21-Jan-15	17-Feb-15	-146										
HKY1160	HKYP6 - Pile Test	0%	28	28	18-Feb-15	17-Mar-15	-74										
HKY1172	HKYP1 - Predrilling	0%	12	12	20-Nov-14	03-Dec-14	11										
HKY1174	HKYP1 - Pre-bored H pile (4 nos)	0%	12	12	18-Feb-15	11-Mar-15	-39										
HKY1220	HKYAB3 - Predrilling	0%	12	12	20-Nov-14	03-Dec-14	-84										
HKY1230	HKYAB3 - Pre-bored H pile (4 nos)	0%	12	12	18-Feb-15	11-Mar-15	-146										
HKY1275	Existing HKY bridge structure removed (TWSR-W)	0%	0	0		20-Nov-14	-84										
HKY1280	HKYP7 - Predrilling	0%	18	18	18-Dec-14	10-Jan-15	-52										
20-Nov-14 ♦ Existing HKY bridge structure removed (TWSR-W)																	

Activity ID	Activity Name	Duration % Complete	Remaining Duration	Original Duration	Start	Finish	Total Float	2014				2015	
								Nov		Dec		Jan	Feb
HKY1320	HKYAB4 - Predrilling	0%	24	24	20-Nov-14	17-Dec-14	-84						
<b>TWSR-East FL Highway S/B Side Section</b>													
HKY1530	HKYAB1 - pile cap & abutment wall	0%	30	30	20-Nov-14	24-Dec-14	-45						
HKY1540	HKYAB1 - Backfilling (~3m)	0%	20	20	27-Dec-14	20-Jan-15	-45						
HKY1580	HKYP3 - Pile cap, Pier and Pier Head	0%	45	45	20-Nov-14	14-Jan-15	-40						
HKY1760	HKYP4 - Pile cap, Pier and Pier Head	60%	18	45	15-Oct-14 A	10-Dec-14	17						
HKY1800	HKYP5 - Pile cap, Pier and Pier Head	0%	45	45	18-Sep-14 A	14-Jan-15	-10						
HKY1840	HKYAB2 - pile cap & abutment wall	0%	60	60	01-Nov-14 A	31-Jan-15	-52						
HKY1850	HKYAB2 - Backfilling (~4m)	0%	27	27	02-Feb-15	12-Mar-15	-52						
<b>TWSR-East Construction</b>													
<b>NB74 (Ch.7930-7980)-FH S/B Side</b>													
<b>Noise Barrier Works</b>													
NB4005	NB74 - Footing & Wall Structure	0%	70	70	03-Feb-15	07-May-15	170						
<b>ZONE 4 (Ch. 7925 to 8700)</b>													
<b>Noise Barrier Along TWSR-West and Laying New Utilities</b>													
<b>NB75 (Ch.7930-8090)-FH N/B Side</b>													
<b>Noise Barrier Works</b>													
NB4100	NB75 - Pre-drilling (Ch7990-8000)-(HKY-P1)	0%	24	24	04-Dec-14	03-Jan-15	11						
<b>Bridge Construction</b>													
<b>New Wo Hop Shek Pedstrian &amp; Cycle Bridge</b>													
<b>General</b>													
WHS1030	Structure steel Shop drawing approval (WHSB)	90%	3	30	23-Aug-14 A	22-Nov-14	290						
WHS1040	Structure steel procurement (WHSB)	0%	150	150	22-Nov-14	21-Apr-15	362						
<b>TWSR-West/ FL Highway N/B Side Section</b>													
WHS1160	WHSP2 - Pre-bored H pile (8 nos)	0%	24	24	04-Dec-14	03-Jan-15	273						
WHS1170	WHSP2 - Pile Test	0%	28	28	03-Jan-15	31-Jan-15	339						
WHS1180	WHSP2 - Pile cap, Pier and Pier Head	0%	45	45	19-Jan-15	19-Mar-15	273						
WHS1200	WHSP6 - Pre-bored H pile (6 nos)	0%	18	18	05-Jan-15	24-Jan-15	304						
WHS1210	WHSP6 - Pile Test	0%	28	28	24-Jan-15	21-Feb-15	383						
WHS1224	WHSP7 - Pre-bored H pile (6 nos)	0%	18	18	26-Jan-15	14-Feb-15	327						
WHS1226	WHSP7 - Pile Test	0%	28	28	14-Feb-15	14-Mar-15	419						
WHS1240	WHSAB1 - Pre-bored H pile (4 nos)	0%	12	12	20-Nov-14	03-Dec-14	273						
WHS1250	WHSAB1 - Pile Test	0%	28	28	04-Dec-14	31-Dec-14	947						
WHS1260	WHSAB1 - pile cap & abutment wall	0%	30	30	18-Dec-14	24-Jan-15	752						
WHS1270	WHSAB1 - Backfilling (~4m)	0%	27	27	26-Jan-15	05-Mar-15	752						
WHS1894	WHSP3 - Pre-bored H pile (6 nos)	0%	18	18	20-Nov-14	10-Dec-14	332						
WHS1896	WHSP3 - Pile Test	0%	28	28	11-Dec-14	07-Jan-15	414						
WHS1898	WHSP3 - Pile cap, Pier and Pier Head	0%	30	30	08-Jan-15	11-Feb-15	327						
WHS1910	WHSP4 - Pre-bored H pile (6 nos)	0%	18	18	11-Dec-14	03-Jan-15	352						
WHS1920	WHSP4 - Pile Test	0%	28	28	03-Jan-15	31-Jan-15	444						
WHS1930	WHSP4 - Pile cap, Pier and Pier Head	0%	30	30	12-Feb-15	26-Mar-15	327						
WHS1950	WHSP5 - Pre-bored H pile (6 nos)	0%	18	18	05-Jan-15	24-Jan-15	361						
WHS1960	WHSP5 - Pile Test	0%	28	28	24-Jan-15	21-Feb-15	459						
<b>Crossing Fanling Highway Section</b>													
WHS1470	WHSP1 - Pile cap, Pier and Pier Head	3.85%	50	52	18-Jun-14 A	20-Jan-15	693						
<b>TWSR-East FL Highway S/B Side Section</b>													
WHS2075	North Abutment Wall (AW1) - Temp Shoring	0%	45	45	20-Nov-14	14-Jan-15	263						
WHS2080	North Abutment Wall (AW1) -pile cap & abutment wall	0%	60	60	15-Jan-15	02-Apr-15	523						
<b>Slip Road Y Construction</b>													
<b>Underground Utility Works</b>													
<b>DN600 and DN900 Watermain</b>													
DN1000	DN600 & DN900 watermain laying (Ch8250-8370)(SA340) (near Z4	0%	50	50	22-Jan-15	28-Mar-15	-434						
DN1030	DN600 & DN900 watermain laying (Ch7925-8050)(SA346)	0%	120	120	03-Feb-15	08-Jul-15	-120						
<b>VO - Wall 76A Construction</b>													
<b>Retaining Wall W76A</b>													
<b>TWSR-East FL Highway S/B Side Section</b>													
W76A1017	W76A backfilling work (bay 3, 4, 6-7)	0%	25	25	14-Nov-14 A	18-Dec-14	-434						
W76A1018	Temp. road work for TTA for W76A (TTA-2)	0%	26	26	19-Dec-14	21-Jan-15	-434						
<b>Other Works</b>													
<b>Retaining Wall W77A</b>													
<b>TWSR-East FL Highway S/B Side Section</b>													
RWZ4.1060	Base slab & Wall (0-3m high)- RW77A (Ch.50-130)	0%	60	60	20-Nov-14	31-Jan-15	293						
RWZ4.1070	Backfilling (0-3m) - RW77A (Ch.50-130)	0%	30	30	02-Feb-15	16-Mar-15	548						
RWZ4.1075	Temp Shoring & Excavation	0%	45	45	15-Jan-15	16-Mar-15	263						
<b>Retaining Wall W77B</b>													
<b>TWSR-East FL Highway S/B Side Section</b>													
RWZ4.1092	Site Clearance	86.67%	4	30	21-Jul-14 A	24-Nov-14	424						
RWZ4.1100	Base slab & Wall (0-3m high)- RW77B (Ch 0-40)	0%	60	60	02-Feb-15	23-Apr-15	368						
<b>Retaining Wall W78</b>													
<b>TWSR-East FL Highway S/B Side Section</b>													
RWZ4.0900	Site Clearance	0%	30	30	25-Nov-14	31-Dec-14	454						
<b>TCSS Works</b>													
<b>TCSS Pre-Construction Works</b>													
TCSS0100	Acquire Design Criteria from Drawings & procurement	0%	180	180	20-Nov-14	07-Jul-15	359						

---

---

**APPENDIX C  
IMPLEMENTATION SCHEDULE OF  
ENVIRONMENTAL MITIGATION MEASURES  
(EMIS)**

---

---

## **Appendix C - Implementation Schedule of Environmental Mitigation Measures (EMIS)**

### **Air Quality – Schedule of Recommended Mitigation Measures**

<b>Impact</b>	<b>Mitigation Measures</b>	<b>Timing</b>	<b>Implementation Status</b>
Air Quality during construction	Restricting heights from which materials are dropped, as far as practicable to minimize the fugitive dust arising from unloading/loading.	During construction	V
	All stockpiles of excavated materials or spoil of more than 50m <sup>3</sup> shall be enclosed, covered or dampened during dry or windy conditions.		@
	Effective water sprays shall be used to control potential dust emission sources such as unpaved haul roads and active construction areas.		+
	All spraying of materials and surfaces shall avoid excessive water usage.		V
	Vehicles that have the potential to create dust while transporting materials shall be covered, with the cover properly secured and extended over the edges of the side and tail boards.		V
	Materials shall be dampened, if necessary, before transportation.		V
	Travelling speeds shall be controlled to reduce traffic induced dust dispersion and re-suspension within the site from the operating haul trucks.		V
	Vehicle washing facilities shall be provided to minimize the quantity of material deposited on public roads.		V

### Noise – Schedule of Recommended Mitigation Measures

Impact	Mitigation Measures	Timing	Implementation Status
Noise during construction	Use of silenced plant or plant equipped with mufflers or dampers in substitute of ordinary plant.	During construction	√
	Reduce the number of equipment and their percentage on-time.		√
	3.5 m and 5.5 m high temporary noise barrier at culvert construction work area (Figure 2a of the Environmental Permit).		#
	3 m high temporary noise barrier along the northern edge of Bridge 12 at ground level (Figure 2b of the Environmental Permit).		#
	2 m high temporary noise barrier along the northern edge of Bridge 12 at bridge level (Figure 2b of the Environmental Permit).		#
	2.5 m high temporary noise barrier along Tai Wo Service Road West (Figure 2c of the Environmental Permit).		#
	3.5m and 7m high temporary noise barrier along Tai Wo Services Road West near Tai Hang (Figure 2c of the Environmental Permit).		#
	7 m high temporary noise barrier along Tai Wo Service Road West near Tai Wo Footbridge work area (Figure 2d of the Environmental Permit).		#
	7 m high temporary noise barrier near Kiu Tau Footbridge work area (Figure 2d of the Environmental Permit).		#
	2.5 m high temporary noise barrier near river diversion work area (Figure 2e of the Environmental Permit).		#

### Water Quality – Schedule of Recommended Mitigation Measures

Impact	Mitigation Measures	Timing	Implementation Status
Water quality during construction	Demolition and reconstruction of bridges <ul style="list-style-type: none"> <li>- Prevent off-site migration through use of sheet piles.</li> <li>- Minimise duration of works as far as practical.</li> <li>- All sewer and drainage connections should be sealed to prevent debris, soil, sand, etc, from entering public sewers/drains.</li> <li>- Site surface runoff should be settled to remove sand/silt before it is discharged into the existing storm drains.</li> </ul>	During construction	V
	Road Widening Works, Earthworks and Culvert Extension Works <ul style="list-style-type: none"> <li>- Wastewater generated from any concrete batching washdown of equipment or similar activities should be discharged into foul sewers, after the removal of settleable solids, and pH adjustment as necessary. All sewage discharges from the study area should meet the TM standards and approval from EPD through the licensing process is required.</li> <li>- Sand traps, oil interceptors and other pollution prevention installations should be provided, properly cleaned and maintained.</li> <li>- Runoff from exposed working areas, unfinished slopes and from unlined temporary channels should be directed to stilling basins and/or silt traps before discharging to the drainage outfalls.</li> <li>- Regular inspections of stilling basins and/or silt traps is required to ensure that sediment is not conveyed into the existing drainage system.</li> <li>- Open stockpiles should be covered with a tarpaulin cover.</li> <li>- During the wet season, any exposed top soils should be covered with a tarpaulin, shotcreted or hydroseeded.</li> <li>- Sand and silt from wash-water from vehicle washing should be settled out before discharging into storm drains.</li> <li>- Fuels should be stored in bunded areas such that spillage can be easily collected.</li> </ul>		@

### Waste – Schedule of Recommended Mitigation Measures

Impact	Mitigation Measures	Timing	Implementation Status
Waste management during construction	<b>General Waste</b> <ul style="list-style-type: none"> <li>- Transport of wastes off site as soon as possible.</li> <li>- Maintenance of accurate waste records.</li> <li>- Minimisation of waste generation for disposal (via reduction/recycling/re-use).</li> <li>- No on-site burning will be permitted.</li> <li>- Use of re-useable metal hoardings/signboards.</li> </ul>	During construction	@
	<b>Vegetation from site clearance</b> <ul style="list-style-type: none"> <li>- Segregation of materials to facilitate disposal.</li> <li>- Mulching to reduce bulk and where possible review opportunities for the possible beneficial use within landscaping areas.</li> </ul>		V
	<b>Demolition Wastes</b> <ul style="list-style-type: none"> <li>- Segregation of materials to facilitate disposal.</li> <li>- Appropriate stockpile management.</li> </ul>		V
	<b>Excavated Materials</b> <ul style="list-style-type: none"> <li>- Segregation of materials to facilitate disposal / reuse.</li> <li>- Appropriate stockpile management.</li> <li>- Re-use of excavated material on or off site (where possible).</li> <li>- Special handling and disposal procedures in the event that contaminated materials are excavated.</li> </ul>		V
	<b>Construction Wastes</b> <ul style="list-style-type: none"> <li>- Segregation of materials to facilitate recycling/reuse (within designated area in appropriate containers/stockpiles).</li> <li>- Appropriate stockpile management.</li> <li>- Planning to reduce over ordering and waste generation.</li> <li>- Recycling and re-use of materials where possible (e.g. metal, wood from formwork)</li> <li>- For material which cannot be re-used/recycled, collection should be carried out by an approved waste contractor for landfill disposal.</li> </ul>		V
	<b>Bentonite Slurries</b> <ul style="list-style-type: none"> <li>- Bentonite slurries should be reused as far as possible.</li> <li>- Disposal in accordance with Practice Note For Professional Persons ProPECC PN 1/94.</li> </ul>		#



	<p>Chemical Wastes</p> <ul style="list-style-type: none"> <li>- Storage within locked, covered and bunded area.</li> <li>- The storage area shall not be located adjacent to sensitive receivers e.g. drains.</li> <li>- Minimise waste production and recycle oils/solvents where possible.</li> <li>- A spill response procedure shall be in place and absorption material available for minor spillages.</li> <li>- Use appropriate and labelled containers.</li> <li>- Educate site workers on site cleanliness/waste management procedures.</li> <li>- If chemical wastes are to be generated, the contractor must register with EPD as a chemical waste producer.</li> <li>- The chemical wastes shall be collected by a licensed chemical waste collector.</li> </ul>		V
	<p>Municipal Wastes</p> <ul style="list-style-type: none"> <li>- Waste shall be stored within a temporary refuse collection facility, in appropriate containers prior to collection and disposal.</li> <li>- Regular, daily collections are required by an approved waste collector.</li> </ul>		V

### Ecology – Schedule of Recommended Mitigation Measures

Impact	Mitigation Measures	Timing	Implementation Status
Ecology during construction	<p>Accurate Delineation of Works Area</p> <ul style="list-style-type: none"> <li>- Boundaries of proposed works areas shall be clearly identified and separated from external areas by a physical barrier to prevent encroachment of adjacent habitats.</li> <li>- Individual trees which fall within the works areas but which work plans do not require removal are to be retained and fenced off to maximize protection.</li> </ul>	During construction	V
	<p>Vegetation Clearance</p> <ul style="list-style-type: none"> <li>- No fires shall be lit within the works area for the purpose of burning cleared vegetation.</li> <li>- The Contractor shall give consideration to mulching the cleared vegetation for recycling within the works area / adjacent land.</li> </ul>		V
	<p>Dust generation</p> <p>There are a number of measures which shall be taken as specified in the Air Pollution Control (Construction Dust) Regulation on 'Dust Control Requirements, including the following key measures to be applied during construction:</p> <ul style="list-style-type: none"> <li>- Vehicle washing facilities to be provided at every discernible or designated vehicle exit point;</li> <li>- All temporary site access roads shall be sprayed with water to suppress dust as necessary;</li> <li>- All dusty materials should be sprayed with water immediately prior to any handling; and</li> <li>- All debris should be covered entirely by impervious sheeting or stored in a sheltered debris collection area.</li> </ul>		V
	<p>Surface Run-off</p> <p>In general, mitigation measures shall be in accordance with ProPECC PN1/94 on 'Construction Site Drainage'. Key measures include:</p> <ul style="list-style-type: none"> <li>- Bund and cover stock piles to avoid run-off;</li> <li>- Channel any run-off through a system of oil, grease and sediment / silt traps and reuse water on site where ever practical;</li> <li>- All vehicle maintenance to be undertaken within a bunded area; and</li> <li>- Maximise vegetation retention on-site to maximise absorption (minimise transport).</li> </ul>		V

### Landscape and Visual Impact – Schedule of Recommended Mitigation Measures

Impact	Mitigation Measures	Timing	Responsibility
Landscape & Visual during construction	Preservation of Existing Vegetation - Trees identified for retention within the project limit would be protected during the works; - The tree transplanting and planting works shall be implemented by approved Landscape Contractors.	During construction	V
	Temporary Works Areas - Where feasible the works areas would be screened using hoarding and existing vegetation would be retained where possible to reduce the landscape and visual impacts arising from the construction activity. The landscape of these works areas would be restored following the completion of the construction phase.		V
	Hoarding - A hoarding would be erected where practicable in the most visually sensitive locations to screen the temporary construction works from the local VSRs.		V
	Top Soils - The works will result in disturbance to extensive areas of topsoil. Topsoil worthy of retention should be stockpiled for use following completion of the civil engineering works. It should either be temporarily vegetated with hydroseeded grass or turned over on a regular basis.		#
	Protection of Important Landscape Features - Important features such as temples, Island House and kilns within the study area, although remote from the proposed works retained and adequately protected.		#

**Legend:**

- V = implemented;
- x = not implemented;
- @ = partially implemented;
- + = recommended and immediately implemented during the site inspection by the Contractor;
- N/A = not applicable - No such work was undertaken or no such material was used on site;
- # = to be implemented.

---

---

**APPENDIX D  
SUMMARY OF ACTION AND LIMIT LEVELS**

---

---

## Appendix D - Summary of Action and Limit Levels

Table 1 – Action and Limit Levels for 1-hour TSP

Location	Action Level	Limit Level
AM2	317.8 µg/m <sup>3</sup>	500 µg/m <sup>3</sup>

Table 2 – Action and Limit Levels for 24-hour TSP

Location	Action Level	Limit Level
AM2	200.7 µg/m <sup>3</sup>	260 µg/m <sup>3</sup>

Table 3 – Action and Limit Levels for Construction Noise (0700-1900 hrs of normal weekdays)

Location	Action Level	Limit Level
M2	When one documented complaint, related to 0700 – 1900 hours on normal weekdays, is received from any one of the sensitive receivers	75 dB(A)
M3*		65/70 dB(A)

\*Daytime noise Limit Level of 70 dB(A) applies to education institutions, while 65dB(A) applies during school examination period

---

---

**APPENDIX E  
CALIBRATION CERTIFICATES OF  
MONITORING EQUIPMENTS**

---

---

### Total Suspended Particulates (TSP) Sampler Field Calibration Report

Station Fanling Government Secondary School (AM2) Operator: Shum Kam Yuen  
 Date: 30-Sep-14 Next Due Date: 30-Nov-14  
 Model No: TE-5170 Verified Against: O.T.S -- 988  
 Equipment No.: A-001-74T Expiration Date: 28-May-2015

Ambient Condition				
Temperature, Ta	306.0	Kelvin	Pressure, Pa	757.1 mmHg

Orifice Transfer Standard Information					
Equipment No.:	988	Slope, mc	1.97518	Intercept, bc	-0.01001
Last Calibration Date:	28-May-14	$mc \times Qstd + bc = [H \times (Pa/760) \times (298/Ta)]^{1/2}$			
Next Calibration Date:	28-May-15				

Calibration of TSP Sampler					
Calibration Point	H in. of water	[H x (Pa/760) x (298/Ta)] <sup>1/2</sup>	Qstd (m <sup>3</sup> /min) X - axis	W in. of oil	[ΔW x (Pa/760) x (298/Ta)] <sup>1/2</sup> Y-axis
1	6.3	2.47	1.26	4.4	2.07
2	5.1	2.22	1.13	3.8	1.92
3	4.5	2.09	1.06	3.3	1.79
4	3.4	1.82	0.92	2.5	1.56
5	1.9	1.36	0.69	1.4	1.17

**By Linear Regression of Y on X**  
 Slope , mw = 1.6093 Intercept, bw = 0.0734  
 Correlation Coefficient\* = 0.9979

**Set Point Calculation**

From the TSP Field Calibration Curve, take Qstd = 1.21 m<sup>3</sup>/min (43 CFM)  
 From the Regression Equation, the "Y" value according to

$$m \times Qstd + b = [W \times (Pa/760) \times (298/Ta)]^{1/2}$$

Therefore, Set Point W = ( m x Qstd + b )<sup>2</sup> x ( 760 / Pa ) x ( Ta / 298 ) = 4.21

\*If Correlation Coefficient < 0.990, check and recalibrate again.

Remarks: \_\_\_\_\_

QC Reviewer: NIS CHAN Signature: [Signature] Date: 3/10/14



TISCH ENVIRONMENTAL, INC.  
 145 SOUTH MIAMI AVE  
 VILLAGE OF CLEVELAND, OH  
 45002  
 513.467.9000  
 877.263.7610 TOLL FREE  
 513.467.9009 FAX

ORIFICE TRANSFER STANDARD CERTIFICATION WORKSHEET TE-5025A

Date - May 28, 2014 Rootsmeter S/N 0438320 Ta (K) - 296  
 Operator Tisch Orifice I.D. - 0988 Pa (mm) - 751.84

PLATE OR Run #	VOLUME START (m3)	VOLUME STOP (m3)	DIFF VOLUME (m3)	DIFF TIME (min)	METER DIFF Hg (mm)	ORFICE DIFF H2O (in.)
1	NA	NA	1.00	1.3790	3.2	2.00
2	NA	NA	1.00	0.9720	6.4	4.00
3	NA	NA	1.00	0.8690	7.9	5.00
4	NA	NA	1.00	0.8260	8.8	5.50
5	NA	NA	1.00	0.6830	12.8	8.00

DATA TABULATION

Vstd	(x axis) Qstd	(y axis)	Va	(x axis) Qa	(y axis)
0.9917	0.7191	1.4113	0.9957	0.7221	0.8874
0.9875	1.0159	1.9959	0.9915	1.0201	1.2549
0.9854	1.1339	2.2315	0.9894	1.1385	1.4030
0.9843	1.1916	2.3405	0.9883	1.1965	1.4715
0.9790	1.4333	2.8227	0.9829	1.4392	1.7747
Qstd slope (m) = 1.97518			Qa slope (m) = 1.23683		
intercept (b) = -0.01001			intercept (b) = -0.00630		
coefficient (r) = 0.99998			coefficient (r) = 0.99998		
y axis = $\text{SQRT}[\text{H2O}(\text{Pa}/760)(298/\text{Ta})]$			y axis = $\text{SQRT}[\text{H2O}(\text{Ta}/\text{Pa})]$		

CALCULATIONS

$$\text{Vstd} = \text{Diff. Vol} [(\text{Pa} - \text{Diff. Hg}) / 760] (298 / \text{Ta})$$

$$\text{Qstd} = \text{Vstd} / \text{Time}$$

$$\text{Va} = \text{Diff Vol} [(\text{Pa} - \text{Diff Hg}) / \text{Pa}]$$

$$\text{Qa} = \text{Va} / \text{Time}$$

For subsequent flow rate calculations:

$$\text{Qstd} = 1/m \{ [\text{SQRT}(\text{H2O}(\text{Pa}/760)(298/\text{Ta}))] - b \}$$

$$\text{Qa} = 1/m \{ [\text{SQRT}(\text{H2O}(\text{Ta}/\text{Pa}))] - b \}$$



## EQUIPMENT CALIBRATION RECORD

Type: Laser Dust Monitor  
 Manufacturer/Brand: SIBATA  
 Model No.: LD-3  
 Equipment No.: A.005.07a  
 Sensitivity Adjustment Scale Setting: 557 CPM

Operator: Mike Shek (MSKM)

### Standard Equipment

Equipment: Rupprecht & Patashnick TEOM®  
 Venue: Cyberport (Pui Ying Secondary School)  
 Model No.: Series 1400AB  
 Serial No: Control: 140AB219899803  
 Sensor: 1200C143659803 K<sub>0</sub>: 12500  
 Last Calibration Date\*: 10 May 2014

\*Remarks: Recommended interval for hardware calibration is 1 year

### Calibration Result

Sensitivity Adjustment Scale Setting (Before Calibration): 557 CPM  
 Sensitivity Adjustment Scale Setting (After Calibration): 557 CPM

Hour	Date (dd-mm-yy)	Time	Ambient Condition		Concentration <sup>1</sup> (mg/m <sup>3</sup> ) Y-axis	Total Count <sup>2</sup>	Count/ Minute <sup>3</sup> X-axis
			Temp (°C)	R.H. (%)			
1	11-05-14	09:30 - 10:30	26.7	75	0.04434	1775	29.58
2	11-05-14	10:30 - 11:30	26.7	75	0.04716	1880	31.33
3	11-05-14	11:30 - 12:30	26.8	76	0.04927	1964	32.73
4	11-05-14	12:30 - 13:30	26.8	75	0.05035	2015	33.58

Note: 1. Monitoring data was measured by Rupprecht & Patashnick TEOM®  
 2. Total Count was logged by Laser Dust Monitor  
 3. Count/minute was calculated by (Total Count/60)

By Linear Regression of Y or X

Slope (K-factor): 0.0015  
 Correlation coefficient: 0.9982

Validity of Calibration Record: 11 May 2015

Remarks:

QC Reviewer: YW Fung

Signature: 

Date: 12 May 2014

## EQUIPMENT CALIBRATION RECORD

Type: Laser Dust Monitor  
 Manufacturer/Brand: SIBATA  
 Model No.: LD-3B  
 Equipment No.: A.005.14a  
 Sensitivity Adjustment Scale Setting: 786 CPM

Operator: Mike Shek (MSKM)

### Standard Equipment

Equipment: Rupprecht & Patashnick TEOM®  
 Venue: Cyberport (Pui Ying Secondary School)  
 Model No.: Series 1400AB  
 Serial No: Control: 140AB219899803  
 Sensor: 1200C143659803 K<sub>0</sub>: 12500  
 Last Calibration Date\*: 10 May 2014

\*Remarks: Recommended interval for hardware calibration is 1 year

### Calibration Result

Sensitivity Adjustment Scale Setting (Before Calibration): 786 CPM  
 Sensitivity Adjustment Scale Setting (After Calibration): 786 CPM

Hour	Date (dd-mm-yy)	Time	Ambient Condition		Concentration <sup>1</sup> (mg/m <sup>3</sup> ) Y-axis	Total Count <sup>2</sup>	Count/ Minute <sup>3</sup> X-axis
			Temp (°C)	R.H. (%)			
1	18-05-14	12:45 - 13:45	28.4	77	0.05027	2158	35.97
2	18-05-14	13:45 - 14:45	28.5	76	0.05161	2211	36.85
3	18-05-14	14:45 - 15:45	28.5	76	0.05235	2247	37.45
4	18-05-14	15:45 - 16:45	28.4	77	0.05203	2233	37.22

Note: 1. Monitoring data was measured by Rupprecht & Patashnick TEOM®  
 2. Total Count was logged by Laser Dust Monitor  
 3. Count/minute was calculated by (Total Count/60)

By Linear Regression of Y or X

Slope (K-factor): 0.0014  
 Correlation coefficient: 0.9969

Validity of Calibration Record: 18 May 2015

Remarks:

QC Reviewer: YW Fung Signature:  Date: 19 May 2014

## EQUIPMENT CALIBRATION RECORD

Type: Laser Dust Monitor  
 Manufacturer/Brand: SIBATA  
 Model No.: LD-3B  
 Equipment No.: A.005.16a  
 Sensitivity Adjustment Scale Setting: 521 CPM

Operator: Mike Shek (MSKM)

### Standard Equipment

Equipment: Rupprecht & Patashnick TEOM®  
 Venue: Cyberport (Pui Ying Secondary School)  
 Model No.: Series 1400AB  
 Serial No: Control: 140AB219899803  
 Sensor: 1200C143659803 K<sub>0</sub>: 12500  
 Last Calibration Date\*: 10 May 2014

\*Remarks: Recommended interval for hardware calibration is 1 year

### Calibration Result

Sensitivity Adjustment Scale Setting (Before Calibration): 521 CPM  
 Sensitivity Adjustment Scale Setting (After Calibration): 521 CPM

Hour	Date (dd-mm-yy)	Time	Ambient Condition		Concentration <sup>1</sup> (mg/m <sup>3</sup> ) Y-axis	Total Count <sup>2</sup>	Count/ Minute <sup>3</sup> X-axis
			Temp (°C)	R.H. (%)			
1	26-07-14	10:30 - 11:30	28.6	77	0.04931	1971	32.85
2	26-07-14	11:45 - 12:45	28.6	77	0.05142	2052	34.20
3	26-07-14	13:15 - 14:15	28.7	77	0.05589	2243	37.38
4	26-07-14	14:40 - 15:40	28.8	78	0.05293	2116	35.27

Note: 1. Monitoring data was measured by Rupprecht & Patashnick TEOM®  
 2. Total Count was logged by Laser Dust Monitor  
 3. Count/minute was calculated by (Total Count/60)

By Linear Regression of Y or X

Slope (K-factor): 0.0015  
 Correlation coefficient: 0.9934

Validity of Calibration Record: 26 July 2015

Remarks:

QC Reviewer: YW Fung

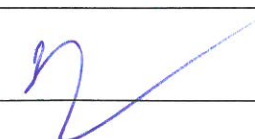
Signature: 

Date: 28 July 2014



## CERTIFICATE OF CALIBRATION

Certificate No.: 13CA1107 01-01

Page 1 of 2

### Item tested

Description:	Sound Level Meter (Type 1)	,	Microphone
Manufacturer:	Rion Co., Ltd.	,	Rion Co., Ltd.
Type/Model No.:	NL-31	,	UC-53A
Serial/Equipment No.:	00320528 / N.007.03A	,	90565
Adaptors used:	-	,	-

### Item submitted by

Customer Name:	AECOM ASIA CO., LTD.
Address of Customer:	-
Request No.:	-
Date of receipt:	07-Nov-2013

Date of test: 08-Nov-2013

### Reference equipment used in the calibration

Description:	Model:	Serial No.	Expiry Date:	Traceable to:
Multi function sound calibrator	B&K 4226	2288444	22-Jun-2014	CIGISMEC
Signal generator	DS 360	33873	15-Apr-2014	CEPREI
Signal generator	DS 360	61227	15-Apr-2014	CEPREI

### Ambient conditions

Temperature:	22 ± 1 °C
Relative humidity:	60 ± 10 %
Air pressure:	1000 ± 10 hPa

### Test specifications

- 1, The Sound Level Meter has been calibrated in accordance with the requirements as specified in BS 7580: Part 1: 1997 and the lab calibration procedure SMTP004-CA-152.
- 2, The electrical tests were performed using an electrical signal substituted for the microphone which was removed and replaced by an equivalent capacitance within a tolerance of ±20%.
- 3, The acoustic calibration was performed using an B&K 4226 sound calibrator and corrections was applied for the difference between the free-field and pressure response of the Sound Level Meter.

### Test results

This is to certify that the Sound Level Meter conforms to BS 7580: Part 1: 1997 for the conditions under which the test was performed.

Details of the performed measurements are presented on page 2 of this certificate.

Actual Measurement data are documented on worksheets.

Approved Signatory:

Huang Jian Min/Feng Jun Qi

Date: 11-Nov-2013

Company Chop:



Comments: The results reported in this certificate refer to the condition of the instrument on the date of calibration and carry no implication regarding the long-term stability of the instrument.



## CERTIFICATE OF CALIBRATION

Certificate No.: 14CA1106 04-01 Page 1 of 2

### Item tested

Description:	Sound Level Meter (Type 1)	,	Microphone
Manufacturer:	Rion Co., Ltd.	,	Rion Co., Ltd.
Type/Model No.:	NL-31	,	UC-53A
Serial/Equipment No.:	00320528 / N.007.03A	,	90565
Adaptors used:	-	,	-

### Item submitted by

Customer Name:	AECOM ASIA CO., LTD.
Address of Customer:	-
Request No.:	-
Date of receipt:	06-Nov-2014

Date of test: 07-Nov-2014

### Reference equipment used in the calibration

Description:	Model:	Serial No.	Expiry Date:	Traceable to:
Multi function sound calibrator	B&K 4226	2288444	15-Jun-2015	CIGISMEC
Signal generator	DS 360	33873	09-Apr-2015	CEPREI
Signal generator	DS 360	61227	09-Apr-2015	CEPREI

### Ambient conditions

Temperature:	22 ± 1 °C
Relative humidity:	65 ± 10 %
Air pressure:	1010 ± 10 hPa

### Test specifications

- 1, The Sound Level Meter has been calibrated in accordance with the requirements as specified in BS 7580: Part 1: 1997 and the lab calibration procedure SMTP004-CA-152.
- 2, The electrical tests were performed using an electrical signal substituted for the microphone which was removed and replaced by an equivalent capacitance within a tolerance of ±20%.
- 3, The acoustic calibration was performed using an B&K 4226 sound calibrator and corrections was applied for the difference between the free-field and pressure responsiveness of the Sound Level Meter.

### Test results

This is to certify that the Sound Level Meter conforms to BS 7580: Part 1: 1997 for the conditions under which the test was performed.

Details of the performed measurements are presented on page 2 of this certificate.

Actual Measurement data are documented on worksheets.

Approved Signatory:

Huang Jian-Min/Feng Jun Qi

Date: 08-Nov-2014

Company Chop:



Comments: The results reported in this certificate refer to the condition of the instrument on the date of calibration and carry no implication regarding the long-term stability of the instrument.



## CERTIFICATE OF CALIBRATION

Certificate No.: 14CA0702 01-01 Page 1 of 2

### Item tested

Description:	Sound Level Meter (Type 1)	Microphone
Manufacturer:	B & K	B & K
Type/Model No.:	2238	4188
Serial/Equipment No.:	2800927 / N.009.06	2791211
Adaptors used:	-	-

### Item submitted by

Customer Name: AECOM ASIA CO., LTD.  
Address of Customer: -  
Request No.: -  
Date of receipt: 02-Jul-2014

Date of test: 03-Jul-2014

### Reference equipment used in the calibration

Description:	Model:	Serial No.	Expiry Date:	Traceable to:
Multi function sound calibrator	B&K 4226	2288444	20-Jun-2015	CIGISMEC
Signal generator	DS 360	33873	09-Apr-2015	CEPREI
Signal generator	DS 360	61227	09-Apr-2015	CEPREI

### Ambient conditions

Temperature:  $21 \pm 1$  °C  
Relative humidity:  $60 \pm 10$  %  
Air pressure:  $1000 \pm 10$  hPa

### Test specifications

1. The Sound Level Meter has been calibrated in accordance with the requirements as specified in BS 7580: Part 1: 1997 and the lab calibration procedure SMTP004-CA-152.
2. The electrical tests were performed using an electrical signal substituted for the microphone which was removed and replaced by an equivalent capacitance within a tolerance of  $\pm 20\%$ .
3. The acoustic calibration was performed using an B&K 4226 sound calibrator and corrections was applied for the difference between the free-field and pressure responsiveness of the Sound Level Meter.

### Test results

This is to certify that the Sound Level Meter conforms to BS 7580: Part 1: 1997 for the conditions under which the test was performed.

Details of the performed measurements are presented on page 2 of this certificate.

Actual Measurement data are documented on worksheets.

Approved Signatory:

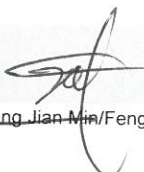
  
Huang Jian Min / Feng Jun Qi

Date: 04-Jul-2014

Company Chop:



Comments: The results reported in this certificate refer to the condition of the instrument on the date of calibration and carry no implication regarding the long-term stability of the instrument.



## CERTIFICATE OF CALIBRATION

Certificate No.: 13CA1107 01-02

Page: 1 of 2

### Item tested

Description: Acoustical Calibrator (Class 1)  
Manufacturer: Rion Co., Ltd.  
Type/Model No.: NC-73  
Serial/Equipment No.: 10307223 / N.004.08  
Adaptors used: -

### Item submitted by

Customer: AECOM ASIA CO., LTD.  
Address of Customer: -  
Request No.: -  
Date of receipt: 07-Nov-2013

Date of test: 08-Nov-2013

### Reference equipment used in the calibration

Description:	Model:	Serial No.	Expiry Date:	Traceable to:
Lab standard microphone	B&K 4180	2341427	17-Apr-2014	SCL
Preamplifier	B&K 2673	2239857	16-Apr-2014	CEPREI
Measuring amplifier	B&K 2610	2346941	24-Apr-2014	CEPREI
Signal generator	DS 360	61227	15-Apr-2014	CEPREI
Digital multi-meter	34401A	US36087050	10-Dec-2013	CEPREI
Audio analyzer	8903B	GB41300350	15-Apr-2014	CEPREI
Universal counter	53132A	MY40003662	15-Apr-2014	CEPREI

### Ambient conditions

Temperature:  $22 \pm 1$  °C  
Relative humidity:  $60 \pm 10$  %  
Air pressure:  $1000 \pm 10$  hPa

### Test specifications

- The Sound Calibrator has been calibrated in accordance with the requirements as specified in IEC 60942 1997 Annex B and the lab calibration procedure SMTP004-CA-156.
- The calibrator was tested with its axis vertical facing downwards at the specific frequency using insert voltage technique.
- The results are rounded to the nearest 0.01 dB and 0.1 Hz and have not been corrected for variations from a reference pressure of 1013.25 hectoPascals as the maker's information indicates that the instrument is insensitive to pressure changes.

### Test results

This is to certify that the sound calibrator conforms to the requirements of annex B of IEC 60942: 1997 for the conditions under which the test was performed. This does not imply that the sound calibrator meets IEC 60942 under any other conditions.

Details of the performed measurements are presented on **page 2** of this certificate.

Approved Signatory:

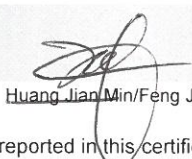
  
Huang Jian Min/Feng Jun Qi

Date: 11-Nov-2013

Company Chop:



**Comments:** The results reported in this certificate refer to the condition of the instrument on the date of calibration and carry no implication regarding the long-term stability of the instrument.

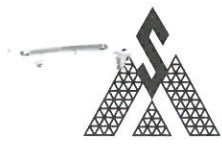

## CERTIFICATE OF CALIBRATION

Certificate No.: 14CA1106 04-02

Page: 1 of 2

### Item tested

Description: Acoustical Calibrator (Class 1)  
Manufacturer: Rion Co., Ltd.  
Type/Model No.: NC-73  
Serial/Equipment No.: 10307223 / N.004.08  
Adaptors used: -

### Item submitted by

Customer: AECOM ASIA CO., LTD.  
Address of Customer: -  
Request No.: -  
Date of receipt: 06-Nov-2014

Date of test: 07-Nov-2014

### Reference equipment used in the calibration

Description:	Model:	Serial No.	Expiry Date:	Traceable to:
Lab standard microphone	B&K 4180	2412857	13-May-2015	SCL
Preamplifier	B&K 2673	2239857	10-Apr-2015	CEPREI
Measuring amplifier	B&K 2610	2346941	08-Apr-2015	CEPREI
Signal generator	DS 360	61227	09-Apr-2015	CEPREI
Digital multi-meter	34401A	US36087050	17-Dec-2014	CEPREI
Audio analyzer	8903B	GB41300350	07-Apr-2015	CEPREI
Universal counter	53132A	MY40003662	11-Apr-2015	CEPREI

### Ambient conditions

Temperature:  $22 \pm 1$  °C  
Relative humidity:  $65 \pm 10$  %  
Air pressure:  $1010 \pm 10$  hPa

### Test specifications

- The Sound Calibrator has been calibrated in accordance with the requirements as specified in IEC 60942 1997 Annex B and the lab calibration procedure SMTP004-CA-156.
- The calibrator was tested with its axis vertical facing downwards at the specific frequency using insert voltage technique.
- The results are rounded to the nearest 0.01 dB and 0.1 Hz and have not been corrected for variations from a reference pressure of 1013.25 hectoPascals as the maker's information indicates that the instrument is insensitive to pressure changes.

### Test results

This is to certify that the sound calibrator conforms to the requirements of annex B of IEC 60942: 1997 for the conditions under which the test was performed. This does not imply that the sound calibrator meets IEC 60942 under any other conditions.

Details of the performed measurements are presented on **page 2** of this certificate.

Approved Signatory:

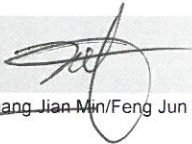
  
Huang Jian Min/Feng Jun Qi

Date: 08-Nov-2014

Company Chop:



**Comments:** The results reported in this certificate refer to the condition of the instrument on the date of calibration and carry no implication regarding the long-term stability of the instrument.





## CERTIFICATE OF CALIBRATION

Certificate No.: 14CA0408 01-02

Page: 1 of 2

### Item tested

Description: Acoustical Calibrator (Class 1)  
Manufacturer: Rion Co., Ltd.  
Type/Model No.: NC-74  
Serial/Equipment No.: 34246490  
Adaptors used: Yes *N.004.10*

### Item submitted by

Customer: AECOM ASIA CO., LTD.  
Address of Customer: -  
Request No.: -  
Date of receipt: 08-Apr-2014

Date of test: 15-Apr-2014

### Reference equipment used in the calibration

Description:	Model:	Serial No.	Expiry Date:	Traceable to:
Lab standard microphone	B&K 4180	2341427	17-Apr-2014	SCL
Preamplifier	B&K 2673	2239857	10-Apr-2015	CEPREI
Measuring amplifier	B&K 2610	2346941	08-Apr-2015	CEPREI
Signal generator	DS 360	61227	09-Apr-2015	CEPREI
Digital multi-meter	34401A	US36087050	17-Dec-2014	CEPREI
Audio analyzer	8903B	GB41300350	07-Apr-2015	CEPREI
Universal counter	53132A	MY40003662	11-Apr-2015	CEPREI

### Ambient conditions

Temperature:  $22 \pm 1$  °C  
Relative humidity:  $60 \pm 10$  %  
Air pressure:  $1000 \pm 10$  hPa

### Test specifications

- The Sound Calibrator has been calibrated in accordance with the requirements as specified in IEC 60942 1997 Annex B and the lab calibration procedure SMTP004-CA-156.
- The calibrator was tested with its axis vertical facing downwards at the specific frequency using insert voltage technique.
- The results are rounded to the nearest 0.01 dB and 0.1 Hz and have not been corrected for variations from a reference pressure of 1013.25 hectoPascals as the maker's information indicates that the instrument is insensitive to pressure changes.

### Test results

This is to certify that the sound calibrator conforms to the requirements of annex B of IEC 60942: 1997 for the conditions under which the test was performed. This does not imply that the sound calibrator meets IEC 60942 under any other conditions.

Details of the performed measurements are presented on page 2 of this certificate.

Approved Signatory:

  
Huang Jian Min/Feng Jun Qi

Date: 23-Apr-2014

Company Chop:



Comments: The results reported in this certificate refer to the condition of the instrument on the date of calibration and carry no implication regarding the long-term stability of the instrument.

---

---

**APPENDIX F  
EM&A MONITORING SCHEDULES**

---

---

**Contract No. HY/2012/06**  
**Widening of Fanling Highway – Tai Hang to Wo Hop Shek Interchange**  
**Impact Monitoring and Audit Schedule for November 2014**

Sunday	Monday	Tuesday	Wednesday	Thursday	Friday	Saturday
						1-Nov
2-Nov	3-Nov	4-Nov	5-Nov	6-Nov	7-Nov	8-Nov
9-Nov		1-hr TSP 24-hr TSP Noise				
10-Nov	11-Nov	12-Nov	13-Nov	14-Nov	15-Nov	
16-Nov	1-hr TSP 24-hr TSP Noise					1-hr TSP 24-hr TSP Noise
17-Nov	18-Nov	19-Nov	20-Nov	21-Nov	22-Nov	
23-Nov					1-hr TSP 24-hr TSP Noise	
24-Nov	25-Nov	26-Nov	27-Nov	28-Nov	29-Nov	
30-Nov				1-hr TSP 24-hr TSP Noise		
31-Nov						

**Contract No. HY/2012/06**  
**Widening of Fanling Highway – Tai Hang to Wo Hop Shek Interchange**  
**Tentative Impact Monitoring and Audit Schedule for December 2014**

Sunday	Monday	Tuesday	Wednesday	Thursday	Friday	Saturday
	1-Dec	2-Dec	3-Dec	4-Dec	5-Dec	6-Dec
			1-hr TSP 24-hr TSP Noise			
7-Dec	8-Dec	9-Dec	10-Dec	11-Dec	12-Dec	13-Dec
		1-hr TSP 24-hr TSP Noise				
14-Dec	15-Dec	16-Dec	17-Dec	18-Dec	19-Dec	20-Dec
	1-hr TSP 24-hr TSP Noise					1-hr TSP 24-hr TSP Noise
21-Dec	22-Dec	23-Dec	24-Dec	25-Dec	26-Dec	27-Dec
		1-hr TSP 24-hr TSP Noise				
28-Dec	29-Dec	30-Dec	31-Dec			
	1-hr TSP 24-hr TSP Noise					

The schedule is subject to change due to unforeseeable circumstances (e.g. adverse weather, etc)

---

---

**APPENDIX G  
IMPACT AIR QUALITY MONITORING  
RESULTS AND THEIR GRAPHICAL  
PRESENTATION**

---

---

**Appendix G  
Impact Air Quality Monitoring Results**

**24-hour TSP Monitoring Results at Station AM2 (Fanling Government Secondary School)**

Date	Weather Condition	Air Temp. (°C)	Atmospheric Pressure(hPa)	Flow Rate (m <sup>3</sup> /min.)		Av. flow (m <sup>3</sup> /min)	Total vol. (m <sup>3</sup> )	Filter Weight (g)		Particulate weight(g)	Elapse Time		Sampling Time(hrs.)	Conc. (µg/m <sup>3</sup> )	Action Level (µg/m <sup>3</sup> )	Limit Level (µg/m <sup>3</sup> )
				Initial	Final			Initial	Final		Initial	Final				
4-Nov-14	Fine	22.8	1017.5	1.314	1.314	1.314	1892.2	2.7514	2.8778	0.1264	4686.02	4710.02	24.00	66.8	200.7	260
10-Nov-14	Sunny	23.3	1017.3	1.314	1.314	1.314	1892.2	2.7444	2.7795	0.0351	4710.02	4734.02	24.00	18.6	200.7	260
15-Nov-14	Sunny	21.9	1019.7	1.314	1.314	1.314	1892.2	2.7792	2.8126	0.0334	4734.02	4758.02	24.00	17.7	200.7	260
21-Nov-14	Fine	22.1	1017.0	1.314	1.314	1.314	1892.2	2.7746	2.8655	0.0909	4758.02	4782.02	24.00	48.0	200.7	260
27-Nov-14	Cloudy	22.2	1015.2	1.314	1.314	1.314	1892.2	2.7703	2.8734	0.1031	4782.02	4806.02	24.00	54.5	200.7	260
													Average	41.1		
													Min	17.7		
													Max	66.8		

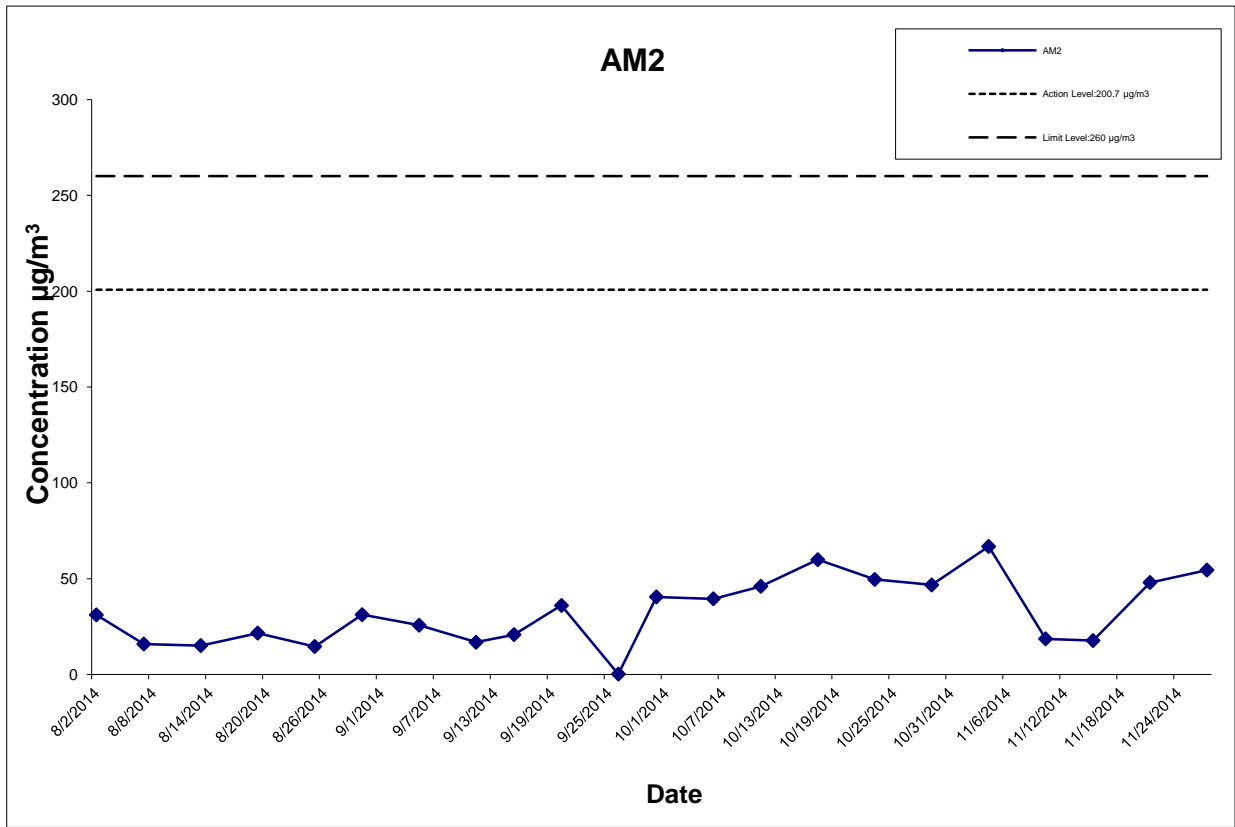

This Drawing has been prepared for the use of AECOM's client. It may not be used, modified, reproduced or relied upon by third parties, except as agreed by AECOM or as required by law. AECOM accepts no responsibility, and denies any liability whatsoever, to any party that uses or relies on this drawing without AECOM's express written consent.

CONTRACT NO. HY/2012/06  
 WIDENING OF FANLING HIGHWAY  
 - TAI HANG TO WO HOP SHEK INTERCHANGE



Graphical Presentation of Impact 24-hour TSP Monitoring Results

Project No.: 60307376

Date: Dec-14

Appendix G

**Appendix G**  
**Impact Air Quality Monitoring Results**

**1-hour TSP Monitoring Results at Station AM2**  
**(Fanling Government Secondary School)**

Date	Start Time (hh:mm)	1st Hour Conc. ( $\mu\text{g}/\text{m}^3$ )	2nd Hour Conc. ( $\mu\text{g}/\text{m}^3$ )	3rd Hour Conc. ( $\mu\text{g}/\text{m}^3$ )
4-Nov-14	12:30	78.8	83.2	81.2
10-Nov-14	10:00	68.2	69.4	70.7
15-Nov-14	13:04	79.4	78.1	79.2
21-Nov-14	12:31	80.5	79.2	81.1
27-Nov-14	13:15	79.6	79.0	81.1
			Average	77.9
			Min	68.2
			Max	83.2



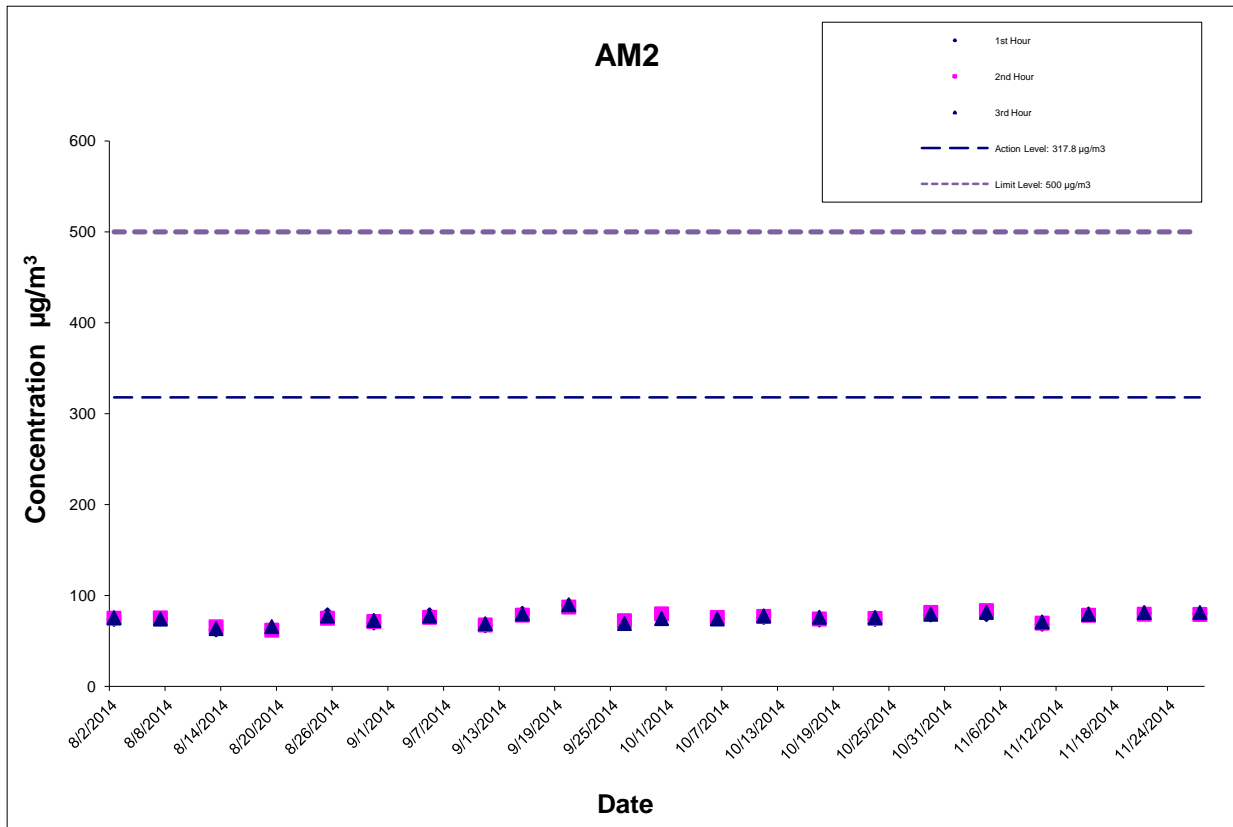

This Drawing has been prepared for the use of AECOM's client. It may not be used, modified, reproduced or relied upon by third parties, except as agreed by AECOM or as required by law. AECOM accepts no responsibility, and denies any liability whatsoever, to any party that uses or relies on this drawing without AECOM's express written consent.

CONTRACT NO. HY/2012/06  
 WIDENING OF FANLING HIGHWAY  
 - TAI HANG TO WO HOP SHEK INTERCHANGE



Graphical Presentation of Impact 1-hour TSP Monitoring Results

Project No.: 60307376

Date: Dec-14

Appendix G

---

---

**APPENDIX H  
METEOROLOGICAL DATA FOR THE  
REPORTING MONTH**

---

---

Climatological Information Services &gt; Extracts of Climatological Data &gt; Extract of Automatic Weather Station &gt; Station: Tai Po Automatic Weather Station, Year: 2014, Month: November

## Extract of Meteorological Observations for Tai Po Automatic Weather Station, November 2014 (Table 1)

Date	Mean Pressure at M.S.L. (hPa)	Air Temperature			Mean Dew Point Temperature (deg C)	Relative Humidity		
		Max. (deg C)	Mean (deg C)	Min. (deg C)		Max. (%)	Mean (%)	Min. (%)
Nov 1	1012.8	28.2	25.0	21.9	21.6	93	82	65
Nov 2	1015.2	26.9	24.8	22.1	18.8	90	70	56
Nov 3	1017.6	22.1	20.6	19.8	13.1	75	62	53
Nov 4	1017.4	23.3	22.4	20.8	17.4	78	73	68
Nov 5	1017.3	24.2	23.5	23.2	19.2	82	77	71
Nov 6	1016.9	26.2	23.7	21.3	19.8	90	79	68
Nov 7	1017.2	24.0	22.4	20.9	20.5	97	89	80
Nov 8	1018.2	21.7	19.4	18.3	18.7	98	96	87
Nov 9	1018.5	23.3	21.2	18.3	18.1	93	83	75
Nov 10	1017.3	24.0	22.7	21.3	19.0	91	80	68
Nov 11	1016.5	24.3	23.3	21.9	19.6	88	80	73
Nov 12	1017.8	22.5	20.8	17.6	17.7	96	82	71
Nov 13	1020.6	21.5	18.6	16.6	14.9	97	80	67
Nov 14	1020.1#	22.1	19.6#	17.1	15.3#	86	77#	67
Nov 15	1019.8	24.4	21.9	20.1	16.6	89	73	57
Nov 16	1017.9	25.2	21.7	18.3	16.7	92	74	56
Nov 17	1019.6	23.9	20.0	17.1	13.2	79	65	53
Nov 18	1021.8	22.8	20.0	16.4	12.8	75	64	55
Nov 19	1020.8	23.2	20.1	17.2	14.0	83	68	54
Nov 20	1018.5	23.3	21.2	19.3	15.9	84	72	56
Nov 21	1017.1	24.5	21.9	19.5	16.8	86	73	56
Nov 22	1016.5	25.4	22.0	18.9	18.1	94	79	58
Nov 23	1016.8	25.3	22.7	21.1	18.6	89	78	64
Nov 24	1015.4	26.9	23.2	20.3	18.7	91	77	60
Nov 25	1013.3	27.2	23.3	19.8	19.4	92	79	64
Nov 26	1013.7	24.0	22.7	20.5	19.0	89	80	73
Nov 27	1015.2	23.0	22.2	21.4	18.6	88	80	71
Nov 28	1014.8	24.5	23.0	21.8	20.3	90	85	78
Nov 29	1013.4	24.1	23.3	22.7	21.1	95	88	75
Nov 30	1012.8	25.9	24.0	22.7	22.4	96	91	81
<b>Mean</b>	1017.0#	24.3	22.0#	19.9	17.9#	89	78#	66

<b>Maximum</b>	1021.8#	28.2	25.0#	23.2	22.4#	98	96#	87
<b>Minimum</b>	1012.8#	21.5	18.6#	16.4	12.8#	75	62#	53

**Extract of Meteorological Observations for Tai Po Automatic Weather Station, November 2014  
(Table 2)**

<b>Date</b>	<b>Total Rainfall (mm)</b>	<b>Prevailing Wind Direction (degrees)</b>	<b>Mean Wind Speed (km/h)</b>
Nov 1	*****	***	*****
Nov 2	*****	***	*****
Nov 3	*****	***	*****
Nov 4	*****	***	*****
Nov 5	*****	***	*****
Nov 6	*****	***	*****
Nov 7	*****	***	*****
Nov 8	*****	***	*****
Nov 9	*****	***	*****
Nov 10	*****	***	*****
Nov 11	*****	***	*****
Nov 12	*****	***	*****
Nov 13	*****	***	*****
Nov 14	*****	***	*****
Nov 15	*****	***	*****
Nov 16	*****	***	*****
Nov 17	*****	***	*****
Nov 18	*****	***	*****
Nov 19	*****	***	*****
Nov 20	*****	***	*****
Nov 21	*****	***	*****
Nov 22	*****	***	*****
Nov 23	*****	***	*****
Nov 24	*****	***	*****
Nov 25	*****	***	*****
Nov 26	*****	***	*****
Nov 27	*****	***	*****
Nov 28	*****	***	*****
Nov 29	*****	***	*****
Nov 30	*****	***	*****
<b>Mean</b>	-----	***	*****
<b>Total</b>	*****	---	-----
<b>Maximum</b>	*****	---	*****
<b>Minimum</b>	*****	---	*****

\*\*\* unavailable

# missing (less than 24 hourly observations a day)

Rainfall measured in increment of 0.5 mm. Amount of < 0.5 mm cannot be detected

Climatological Information Services &gt; Extracts of Climatological Data &gt; Extract of Automatic Weather Station &gt; Station: Tai Mei Tuk Automatic Weather Station, Year: 2014, Month: November

### Extract of Meteorological Observations for Tai Mei Tuk Automatic Weather Station, November 2014 (Table 1)

Date	Mean Pressure at M.S.L. (hPa)	Air Temperature			Mean Dew Point Temperature (deg C)	Relative Humidity		
		Max. (deg C)	Mean (deg C)	Min. (deg C)		Max. (%)	Mean (%)	Min. (%)
Nov 1	*****	30.5	25.5	22.8	****	***	***	***
Nov 2	*****	28.2	24.7	21.3	****	***	***	***
Nov 3	*****	22.1	20.9	19.9	****	***	***	***
Nov 4	*****	23.7	22.5	21.5	****	***	***	***
Nov 5	*****	26.3	23.5	22.8	****	***	***	***
Nov 6	*****	29.8	24.5	22.3	****	***	***	***
Nov 7	*****	24.1	22.2	20.9	****	***	***	***
Nov 8	*****	21.5	19.7	18.6	****	***	***	***
Nov 9	*****	25.1	21.6	18.9	****	***	***	***
Nov 10	*****	25.9	23.1	21.7	****	***	***	***
Nov 11	*****	26.8	23.5	22.1	****	***	***	***
Nov 12	*****	24.3	21.5	18.2	****	***	***	***
Nov 13	*****	22.1	19.1	17.5	****	***	***	***
Nov 14	*****	22.9	20.2#	17.7	****	***	***	***
Nov 15	*****	26.3	22.1	19.5	****	***	***	***
Nov 16	*****	28.5	23.0#	19.8	****	***	***	***
Nov 17	*****	25.0	20.6	17.5	****	***	***	***
Nov 18	*****	24.4	20.4	17.0	****	***	***	***
Nov 19	*****	24.8	20.9	18.4	****	***	***	***
Nov 20	*****	25.4	21.4	18.9	****	***	***	***
Nov 21	*****	26.5	22.2	19.2	****	***	***	***
Nov 22	*****	27.0	23.8#	20.7	****	***	***	***
Nov 23	*****	27.1	23.0	20.9	****	***	***	***
Nov 24	*****	28.5	23.6	20.8	****	***	***	***
Nov 25	*****	29.9	24.3	20.7	****	***	***	***
Nov 26	*****	25.5	22.9	21.0	****	***	***	***
Nov 27	*****	23.9	22.3	21.1	****	***	***	***
Nov 28	*****	26.0	23.3	21.7	****	***	***	***
Nov 29	*****	24.0	23.3	22.9	****	***	***	***
Nov 30	*****	28.3	24.4	22.8	****	***	***	***
<b>Mean</b>	*****	25.8	22.5#	20.3	****	***	***	***

<b>Maximum</b>	*****	30.5	25.5#	22.9	****	***	***	***
<b>Minimum</b>	*****	21.5	19.1#	17.0	****	***	***	***

**Extract of Meteorological Observations for Tai Mei Tuk Automatic Weather Station,  
November 2014 (Table 2)**

<b>Date</b>	<b>Total Rainfall (mm)</b>	<b>Prevailing Wind Direction (degrees)</b>	<b>Mean Wind Speed (km/h)</b>
Nov 1	0.0	140	6.6
Nov 2	0.0	050	15.8
Nov 3	0.0	040	11.3
Nov 4	0.0	110	12.3
Nov 5	0.0	100	15.0
Nov 6	0.0	040	9.0
Nov 7	8.5	080	25.5
Nov 8	7.5	050	12.1
Nov 9	0.5	040	11.4
Nov 10	0.0	090	15.0
Nov 11	0.0	090	12.8
Nov 12	0.0	040	10.0
Nov 13	0.0	040	10.8
Nov 14	0.0#	040#	10.6#
Nov 15	0.0	060	16.0
Nov 16	0.0	050#	10.3#
Nov 17	0.0	030	12.2
Nov 18	0.0	040	11.7
Nov 19	0.0	050	11.8
Nov 20	0.0	050	14.4
Nov 21	0.0	050	10.8
Nov 22	0.0#	090#	13.9#
Nov 23	0.0	090	14.2
Nov 24	0.0	060	8.7
Nov 25	0.0	260	3.3
Nov 26	0.0	090	14.2
Nov 27	0.0	080	15.3
Nov 28	0.0	130	6.7
Nov 29	0.0	090	14.2
Nov 30	1.0	070	9.5
<b>Mean</b>	-----	050#	12.2#
<b>Total</b>	17.5#	---	-----
<b>Maximum</b>	8.5#	---	25.5#
<b>Minimum</b>	0.0#	---	3.3#

\*\*\* unavailable

# missing (less than 24 hourly observations a day)

Rainfall measured in increment of 0.5 mm. Amount of < 0.5 mm cannot be detected



---

---

**APPENDIX I  
IMPACT DAYTIME CONSTRUCTION NOISE  
MONITORING RESULTS AND THEIR  
GRAPHICAL PRESENTATION**

---

---

## Appendix I Impact Daytime Construction Noise Monitoring Resu

### Location : M2 (West Tai Wo - Free Field)

Day time 07:00-19:00 hrs Normal Weekdays Impact Noise Monitoring Results

Date	Measured Noise Level for 30-min, dB(A)				Limit Level, dB(A)	Exceedance (Y/N)
	Start Time	Leq*	L10*	L90*		
4-Nov-14	13:02	71.2	74.8	69.6	75	N
10-Nov-14	14:00	69.8	72.0	67.5	75	N
21-Nov-14	11:37	65.9	68.0	61.9	75	N
27-Nov-14	14:12	64.7	66.9	62.0	75	N
	Min	64.7	66.9	61.9		
	Max	71.2	74.8	69.6		
	Average	68.7	71.6	66.5		

### Location : M3 (Fanling Government Secondary School- Façade)

Day time 07:00-19:00 hrs Normal Weekdays Impact Noise Monitoring Results

Date	Measured Noise Level for 30-min, dB(A)				Limit Level, dB(A)^	Exceedance (Y/N)
	Start Time	Leq	L10	L90		
4-Nov-14	14:00	63.0	66.4	61.0	70	N
10-Nov-14	13:10	60.0	61.5	57.5	70	N
21-Nov-14	13:00	63.0	65.6	60.8	70	N
27-Nov-14	13:20	62.8	64.1	59.8	70	N
	Min	60.0	61.5	57.5		
	Max	63.0	66.4	61.0		
	Average	62.4	64.8	60.0		

\* +3dB(A) Façade effect correction included

^ Limit Level of 70dB(A) applies to education institutes while 65dB(A) applies during school examination period.

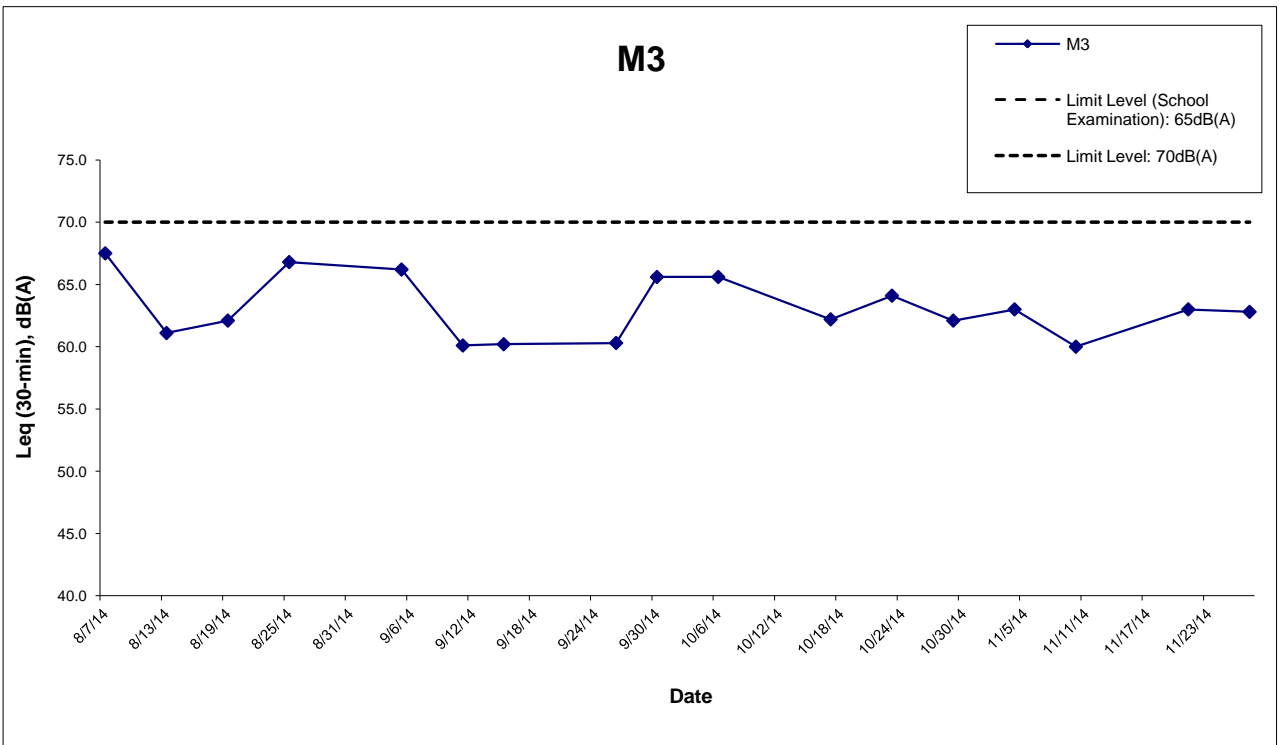
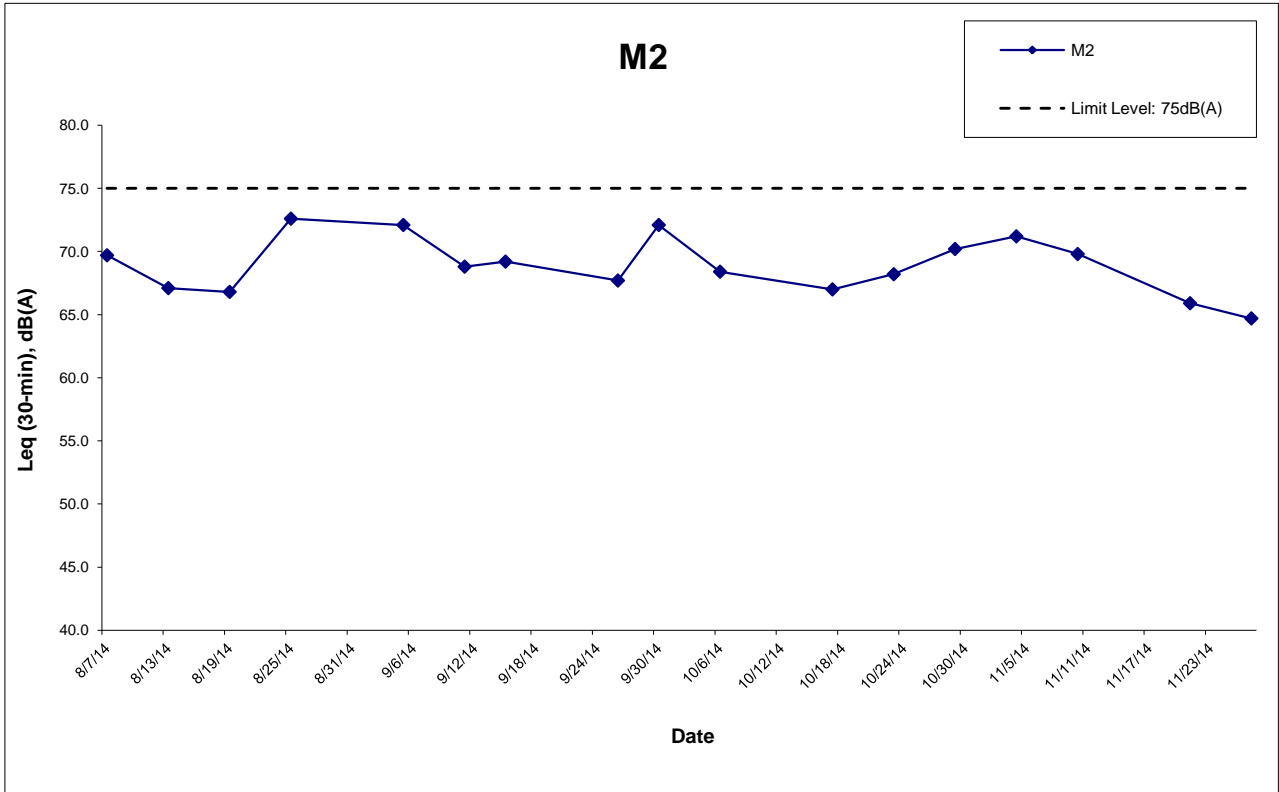

Remark:

^ Limit Level of 70dB(A) applies to education institutes while 65dB(A) applies during school examination period.

This Drawing has been prepared for the use of AECOM's client. It may not be used, modified, reproduced or relied upon by third parties, except as agreed by AECOM or as required by law. AECOM accepts no responsibility, and denies any liability whatsoever, to any party that uses or relies on this drawing without AECOM's express written consent.

CONTRACT NO. HY/2012/06  
 WIDENING OF FANLING HIGHWAY  
 - TAI HANG TO WO HOP SHEK INTERCHANGE



Graphical Presentation of Impact Daytime Construction Noise  
 Monitoring Results

Project No.: 60307376

Date: Dec-14

Appendix I

---

---

**APPENDIX J  
EVENT ACTION PLAN**

---

---

## Appendix J – Event Action Plan

### Event / Action Plan for Air Quality

Event	Action			
	ET Leader	IEC	ER	Contractor
<b>Action Level</b>				
Exceedance for one sample	<ol style="list-style-type: none"> <li>1. Identify source;</li> <li>2. Inform IEC and ER;</li> <li>3. Repeat measurement to confirm finding;</li> <li>4. Increase monitoring frequency to daily.</li> </ol>	<ol style="list-style-type: none"> <li>1. Check monitoring data submitted by ET;</li> <li>2. Check Contractor's working method.</li> </ol>	<ol style="list-style-type: none"> <li>1. Notify Contractor.</li> </ol>	<ol style="list-style-type: none"> <li>1. Rectify any unacceptable practice;</li> <li>2. Amend working methods if appropriate.</li> </ol>
Exceedance for two or more consecutive samples	<ol style="list-style-type: none"> <li>1. Identify source;</li> <li>2. Inform IEC and ER;</li> <li>3. Repeat measurements to confirm findings;</li> <li>4. Increase monitoring frequency to daily;</li> <li>5. Discuss with IEC and Contractor on remedial actions required;</li> <li>6. If exceedance continues, arrange meeting with IEC and ER;</li> <li>7. If exceedance stops, cease additional monitoring.</li> </ol>	<ol style="list-style-type: none"> <li>1. Check monitoring data submitted by ET;</li> <li>2. Check Contractor's working method;</li> <li>3. Discuss with ET and Contractor on possible remedial measures;</li> <li>4. Advise the ER on the effectiveness of the proposed remedial measures;</li> <li>5. Supervise Implementation of remedial measures.</li> </ol>	<ol style="list-style-type: none"> <li>1. Confirm receipt of notification of failure in writing;</li> <li>2. Notify Contractor;</li> <li>3. Ensure remedial measures properly implemented.</li> </ol>	<ol style="list-style-type: none"> <li>1. Submit proposals for remedial actions to IEC within 3 working days of notification;</li> <li>2. Implement the agreed proposals;</li> <li>3. Amend proposal if appropriate.</li> </ol>

Event / Action Plan for Air Quality

Event Action Level	Action			
	ET Leader	IEC	ER	Contractor
<b>Limit Level</b>				
Exceedance for one sample	<ol style="list-style-type: none"> <li>1. Identify source;</li> <li>2. Inform IEC, ER, Contractor and EPD;</li> <li>3. Repeat measurement to confirm finding;</li> <li>4. Increase monitoring frequency to daily;</li> <li>5. Assess effectiveness of Contractor's remedial actions and keep IEC, EPD and ER informed of the results.</li> </ol>	<ol style="list-style-type: none"> <li>1. Check monitoring data submitted by ET;</li> <li>2. Check Contractor's working method;</li> <li>3. Discuss with ET and Contractor on possible remedial measures;</li> <li>4. Advise ER on the effectiveness of the proposed remedial measures;</li> <li>5. Supervise implementation of remedial measures.</li> </ol>	<ol style="list-style-type: none"> <li>1. Confirm receipt of notification of exceedance in writing;</li> <li>2. Notify Contractor;</li> <li>3. Ensure remedial measures properly implemented.</li> </ol>	<ol style="list-style-type: none"> <li>1. Take immediate action to avoid further exceedance;</li> <li>2. Submit proposals for remedial actions to IEC within 3 working days of notification;</li> <li>3. Implement the agreed proposals;</li> <li>4. Amend proposal if appropriate.</li> </ol>
Exceedance for two or more consecutive samples	<ol style="list-style-type: none"> <li>1. Notify IEC, ER, Contractor and EPD;</li> <li>2. Identify source;</li> <li>3. Repeat measurement to confirm findings;</li> <li>4. Increase frequency to daily;</li> <li>5. Analyse Contractor's working procedures to determine possible mitigation to be;</li> <li>6. Arrange meeting with IEC and ER to discuss the remedial actions to be taken;</li> <li>7. Assess effectiveness of Contractor's remedial actions and keep IEC, EPD and ER informed of the results;</li> <li>8. If exceedance stops, cease additional monitoring.</li> </ol>	<ol style="list-style-type: none"> <li>1. Discuss amongst ER, ET, and Contractor on the potential remedial actions;</li> <li>2. Review Contractor's remedial actions whenever necessary to assure their effectiveness and advise ER accordingly;</li> <li>3. Supervise the implementation of remedial measures.</li> </ol>	<ol style="list-style-type: none"> <li>1. Confirm receipt of notification of exceedance in writing;</li> <li>2. Notify Contractor;</li> <li>3. In consultation with the IEC, agree with the Contractor on the remedial measures to be implemented;</li> <li>4. Ensure remedial measures properly implemented;</li> <li>5. If exceedance continues, consider what portion of the work is responsible and instruct the Contractor to stop that portion of work until the exceedance is abated.</li> </ol>	<ol style="list-style-type: none"> <li>1. Take immediate action to avoid further exceedance;</li> <li>2. Submit proposals for remedial actions to IEC within 3 working days of notification;</li> <li>3. Implement the agreed proposals;</li> <li>4. Resubmit proposals if problem still not under control;</li> <li>5. Stop the relevant portion of works as determined by ER until the exceedance is abated.</li> </ol>

Event / Action Plan for Noise Impact

Event Limit Level	Action			
	ET Leader	IEC	ER	Contractor
Action Level	<ol style="list-style-type: none"> <li>1. Notify IEC and the Contractor.</li> <li>2. Carry out investigation.</li> <li>3. Report the results of investigation to IEC and the Contractor.</li> <li>4. Discuss with the Contractor and formulate remedial measures.</li> <li>5. Increase monitoring frequency to check mitigation effectiveness.</li> </ol>	<ol style="list-style-type: none"> <li>1. Review with analysed results submitted by ET.</li> <li>2. Review the proposed remedial measures by the Contractor and advise ER accordingly.</li> <li>3. Supervise the implement of remedial measures.</li> </ol>	<ol style="list-style-type: none"> <li>1. Confirm receipt of notification of failure in writing.</li> <li>2. Notify the Contractor.</li> <li>3. Require the Contractor to propose remedial measures for the analysed noise problem.</li> <li>4. Ensure remedial measures are properly implemented.</li> </ol>	<ol style="list-style-type: none"> <li>1. Submit noise mitigation proposals to IEC.</li> <li>2. Implement noise mitigation proposals.</li> </ol>
Limit Level	<ol style="list-style-type: none"> <li>1. Notify, IEC, ER, EPD and the Contractor.</li> <li>2. Identify the source.</li> <li>3. Repeat measurement to confirm findings.</li> <li>4. Increase monitoring frequency.</li> <li>5. Carry out analysis of Contractor's working procedures to determine possible mitigation to be implemented.</li> <li>6. Inform IEC, ER, and EPD the causes &amp; actions taken for the exceedances.</li> <li>7. Assess effectiveness of the Contractor's remedial actions and keep IEC, EPD and ER informed of the results.</li> <li>8. If exceedance stops, cease additional monitoring.</li> </ol>	<ol style="list-style-type: none"> <li>1. Discuss amongst ER, ET Leader and the Contractor on the potential remedial actions.</li> <li>2. Review the Contractor's remedial actions whenever necessary to assure their effectiveness and advise ER accordingly.</li> <li>3. Supervise the implementation of remedial measures.</li> </ol>	<ol style="list-style-type: none"> <li>1. Confirm receipt of notification of failure in writing.</li> <li>2. Notify the Contractor.</li> <li>3. Require the Contractor to propose remedial measures for the analysed noise problem.</li> <li>4. Ensure remedial measures are properly implemented.</li> <li>5. If exceedance continues, consider what activity of the work is responsible and instruct the Contractor to stop that activity of work until the exceedance is abated.</li> </ol>	<ol style="list-style-type: none"> <li>1. Take immediate action to avoid further exceedance.</li> <li>2. Submit proposals for remedial actions to IEC within 3 working days of notification.</li> <li>3. Implement the agreed proposals.</li> <li>4. Resubmit proposals if problem still not under control.</li> <li>5. Stop the relevant activity of works as determined by the ER until the exceedance is abated.</li> </ol>

---

---

**APPENDIX K  
SITE INSPECTION SUMMARIES**

---

---



## Site Inspection Summary

### Inspection Information

Contract No.	HY/2012/06
Date:	4 November 2014
Time:	14:00
Inspection No.:	51

### Non-compliance

Nil
-----

### Observations

<p><u>Follow-up Observation(s)</u></p> <p>Nil.</p> <p><u>New Observation(s)</u></p> <p>1. Stockpile of dusty materials were observed without dust suppression measures. The Contractor should spray the stockpiles with water or cover them entirely by tarpaulin for dust suppression.</p>
--

### Remarks

Nil
-----

*Inspection Information*

Contract No.	HY/2012/06
Date:	13 November 2014
Time:	14:00
Inspection No.:	52

*Non-compliance*

Nil
-----

*Observations*

<p><u>Follow-up Observation(s)</u></p> <p>1. Stockpile of dusty materials was covered. (Closed)</p> <p><u>New Observation(s)</u></p> <p>Nil.</p> <p><u>Reminder(s)</u></p> <p>Site area ID1 was observed to be dry. The Contractor was reminded to enhance the water spraying frequency for dust suppression.</p>
---

*Remarks*

Nil
-----

*Inspection Information*

Contract No.	HY/2012/06
Date:	18 November 2014
Time:	14:00
Inspection No.:	53

*Non-compliance*

Nil
-----

*Observations*

<p><u>Follow-up Observation(s)</u></p> <p>Nil.</p> <p><u>New Observation(s)</u></p> <p>Nil.</p> <p><u>Reminder(s)</u></p> <p>The site area of Zone 1 was observed to be dry. The Contractor was reminded to set up watering facilities as soon as possible and enhance the water spraying frequency to suppress dust.</p>
---

*Remarks*

Nil
-----

*Inspection Information*

Contract No.	HY/2012/06
Date:	25 November 2014
Time:	14:00
Inspection No.:	54

*Non-compliance*

Nil
-----

*Observations*

<p><u>Follow-up Observation(s)</u></p> <p>Nil.</p> <p><u>New Observation(s)</u></p> <p>1. Stagnant water and general refuse was observed at ID1. The Contractor should clear the stagnant water and refuse to prevent mosquito breeding and maintain good housekeeping.</p>
--

*Remarks*

Nil
-----

---

---

**APPENDIX L  
STATISTICS ON COMPLAINTS,  
NOTIFICATION OF SUMMONS AND  
SUCCESSFUL PROSECUTIONS**

---

---

## Appendix L

### Statistics on Complaints, Notifications of Summons and Successful Prosecutions

	<b>Date Received</b>	<b>Subject</b>	<b>Status</b>	<b>Total no. followed up by the ET this month</b>	<b>Total no. followed up by the ET since project commencement</b>
<b>Environmental complaints</b>	19 December 2013	EPD referred a complaint from Lot no. 116 of Fui Sha Wai at Tai Hang of Tai Po which is concerned about the construction noise and diesel-like smell generated from construction activities nearby which caused nuisance and health problems on 19 December 2013 morning.	Closed	1	3
	24 February 2014	EPD referred an air-and-odour complaint on 24 February 2014. The complainant complained about the construction site located near the bus stop in Fui Sha Wai, Tai Hang, Tai Wo Service Road West. When construction works were carried out, odour, white smoke and dust were generated. The complainant asked for follow-up actions.	Closed		

	<b>Date Received</b>	<b>Subject</b>	<b>Status</b>	<b>Total no. followed up by the ET this month</b>	<b>Total no. followed up by the ET since project commencement</b>
	23 October 2014	<p>EPD referred an air complaint on 24 October 2014.</p> <p>A resident complained against the excavation works of Tai Wo Service Road West between Nam Wah Po &amp; Tai Hang Tsuen, which have piled up high stockpiles, causing serious dust nuisance to his house.</p> <p>The resident also complained that the stockpiles have not been covered and watered properly. He now requires the EPD to follow up.</p> <p>The location of complaint is near Lamppost Location EB5717.</p>	Closed		
<b>Notification of summons</b>	-	-	-	0	0
<b>Successful Prosecutions</b>	-	-	-	0	0