

**Environmental Protection Department**

Contract No. HY/2012/06

**Widening of Fanling Highway  
- Tai Hang to Wo Hop Shek  
Interchange**

**Monthly EM&A Report  
For August 2014**

[09/2014]

	Name	Signature
Prepared & Checked:	Joanne Ko	
Reviewed & Approved:	Y W Fung	

Version:	Rev. 0	Date: 15 September 2014
----------	--------	-------------------------

**Disclaimer**

This report is prepared for Environmental Protection Department and is given for its sole benefit in relation to and pursuant to Contract No. HY/2012/06 and may not be disclosed to, quoted to or relied upon by any person other than Environmental Protection Department without our prior written consent. No person (other than Environmental Protection Department) into whose possession a copy of this report comes may rely on this report without our express written consent and Environmental Protection Department may not rely on it for any purpose other than as described above.

AECOM Asia Co. Ltd.  
15/F, Grand Central Plaza, Tower 1, 138 Shatin Rural Committee Road, Shatin, NT, Hong Kong  
Tel: (852) 3922 9000 Fax: (852) 2317 7609 www.aecom.com

Our ref AFK/TK/jn/T329380/22.05/L-0040  
T 2828 5919  
E terence.kong@mottmac.com.hk  
Your ref

Hyder-Arup-Black & Veatch Joint Venture  
c/o Hyder Consulting Limited  
47/F Hopewell Centre  
183 Queen's Road East  
Wanchai, Hong Kong

Dear Sir,

15 September 2014  
By Fax (2805 5028) & Post

**Attn: Mr. James Penny**

**Environmental Monitoring and Audit (EM&A) for Widening of Tolo Highway/Fanling Highway between Island House Interchange and Fanling Stage 2 (between Tai Hang to Wo Hop Shek Interchange) Environmental Permit No. EP-324/2008/B Condition 3.3 – Submission of Monthly EM&A Report – August 2014 for the portion of Stage 2 works under Contract No. HY/2012/06**

We refer to the revised Monthly EM&A Report – August 2014 received on 10 and 15 September 2014 submitted by the Environmental Team via email. Pursuant to Environmental Permit Condition 3.3, I hereby verify the Monthly EM&A Report – August 2014 (Rev. 0) for the portion of works under Stage 2 of the captioned Project which is managed under Contract No. HY/2012/06.

Yours faithfully  
for MOTT MACDONALD HONG KONG LIMITED



Terence Kong  
Independent Environmental Checker

c.c. HyD – Mr. Chung Lok Chin / Mr. Tang Man Kai (Fax: 2714 5198)  
AECOM – Mr. Y W Fung (Fax:2891 0305)

## TABLE OF CONTENTS

	Page
EXECUTIVE SUMMARY	3
1 INTRODUCTION	5
1.1 Background	5
1.2 Scope of Report	6
1.3 Project Organization	6
1.4 Summary of Construction Works	6
1.5 Summary of EM&A Programme Requirements	7
2 AIR QUALITY MONITORING	8
2.1 Monitoring Requirements	8
2.2 Monitoring Equipment	8
2.3 Monitoring Locations	8
2.4 Monitoring Parameters and Frequency	8
2.5 Monitoring Methodology	9
2.6 Monitoring Schedule for the Reporting Month	10
2.7 Results and Observations	11
3 NOISE MONITORING	12
3.1 Monitoring Requirements	12
3.2 Monitoring Equipment	12
3.3 Monitoring Locations	12
3.4 Monitoring Parameters and Frequency	12
3.5 Monitoring Methodology	13
3.6 Monitoring Schedule for the Reporting Month	13
3.7 Monitoring Results	13
4 ENVIRONMENTAL SITE INSPECTION AND AUDIT	15
4.1 Site Inspection	15
4.2 Advice on the Solid and Liquid Waste Management Status	16
4.3 Environmental Licenses and Permits	16
4.4 Implementation Status of Environmental Mitigation Measures	18
4.5 Summary of Exceedances of the Environmental Quality Performance Limit	18
4.6 Summary of Complaints, Notification of Summons and Successful Prosecutions	18
5 FUTURE KEY ISSUES	19
5.1 Construction Programme for the Coming Months	19
5.2 Key Issues for the Coming Month	19
5.3 Monitoring Schedule for the Coming Month	19
6 CONCLUSIONS AND RECOMMENDATIONS	20
6.1 Conclusions	20
6.2 Recommendations	20

## List of Tables

Table 1.1	Contact Information of Key Personnel
Table 2.1	Air Quality Monitoring Equipment
Table 2.2	Locations of Impact Air Quality Monitoring Station
Table 2.3	Air Quality Monitoring Parameters, Frequency and Duration
Table 2.4	Summary of 1-hour TSP Monitoring Results in the Reporting Period
Table 2.5	Summary of 24-hour TSP Monitoring Results in the Reporting Period
Table 3.1	Noise Monitoring Equipment
Table 3.2	Locations of Impact Noise Monitoring Stations
Table 3.3	Noise Monitoring Parameters, Frequency and Duration
Table 3.4	Summary of Construction Noise Monitoring Results in the Reporting Period
Table 4.1	Summary of Waste Flow Table
Table 4.2	Summary of Environmental Licensing and Permit Status

## Figures

Figure 1.1	General Project Layout Plan
Figure 1.2a-b	Locations of Monitoring Station
Figure 4.1	Environmental Complaint Handling Procedures

## List of Appendices

Appendix A	Project Organization Structure
Appendix B	Construction Programme
Appendix C	Implementation Schedule of Environmental Mitigation Measures (EMIS)
Appendix D	Summary of Action and Limit Levels
Appendix E	Calibration Certificates of Monitoring Equipments
Appendix F	EM&A Monitoring Schedules
Appendix G	Impact Air Quality Monitoring Results and their Graphical Presentation
Appendix H	Meteorological Data for the Reporting Month
Appendix I	Impact Daytime Construction Noise Monitoring Results and their Graphical Presentation
Appendix J	Event Action Plan
Appendix K	Site Inspection Summaries
Appendix L	Statistics on Complaints, Notifications of Summons and Successful Prosecutions

## EXECUTIVE SUMMARY

The proposed widening of Tolo Highway and Fanling Highway between Island House Interchange and Fanling (the Project) is a Designated Project under the Environmental Impact Assessment Ordinance (Cap. 499) (EIAO). An Environmental Impact Assessment (EIA) Report (the approved EIA Report) together with an Environmental Monitoring and Audit (EM&A) Manual (the approved EM&A Manual) were completed and approved under the EIAO on 14 July 2000 (Register Number: EIA-043/2000).

The objective of the Project “Widening of Tolo Highway / Fanling Highway between Island House Interchange and Fanling” is to widen Tolo Highway and Fanling Highway to dual 4-lane carriageway in order to alleviate the current traffic congestion problems and to cope with the increasing transport demands to and from the urban areas and also cross boundary traffic.

The Project is a designated project and governed by an Environmental Permit (EP-324/2008) issued by the EPD on 23 December 2008. Subsequently, the EPD issued a Variation of Environmental Permit (EP-324/2008/A) (VEP) on 31 January 2012. The VEP (EP-324/2008/B) was subsequently granted on 17 March 2014 which superseded the previous EP (EP-324/2008/A).

The construction works for this Project are delivered in 2 stages i.e. Stage 1 (between Island House Interchange and Tai Hang) and Stage 2 (between Tai Hang and Wo Hop Shek Interchange). Stage 2 would be implemented under two works contracts. Contract No. HY2012/06 “Widening of Fanling Highway – Tai Hang to Wo Hop Shek Interchange” and the entrusted portion to CEDD under Contract No. CV/2012/09 “Liantang/Heung Yuen Wai Boundary Control Point Site Formation and Infrastructure Works – Contract 3”. This report focuses on Contract No. HY2012/06 “Widening of Fanling Highway – Tai Hang to Wo Hop Shek Interchange” in Stage 2 of the Project only.

Pursuant to the EP (EP-324/2008/B) Condition 2.7, the Capture Survey Trip Report for Ma Wat River Northern Meander (Version 2) for the Project was submitted on 24 December 2013 by the Environmental Team (ET) and verified by the Independent Environmental Checker (IEC) on 6 January 2014.

The construction phase of the Contract under the EP and the Environmental Monitoring and Audit (EM&A) programme of the contract commenced on 21 November 2013. The impact environmental monitoring and audit includes air quality and noise monitoring.

This report documents the findings of EM&A works conducted in the period between 1 and 31 August 2014. As informed by the Contractor, construction activities in the reporting period were:

- Site clearance
- Ground investigation
- Tree felling and transplantation
- Piling works
- Pipe laying
- Retaining wall construction
- Noise barrier construction
- Excavation
- Backfilling
- Drainage
- Temporary bridge construction

### Reporting Change

There was no reporting change required in the reporting month.

### Breaches of Action and Limit Levels for Air Quality

No exceedance of Action and Limit Level was recorded for 1-hour and 24-hour TSP monitoring in the reporting month.

### **Breaches of Action and Limit Levels for Noise**

No Action or Limit Level exceedance of construction noise was recorded in the reporting month. No noise complaints related to 0700 – 1900 hours on normal weekdays was received and followed by Environmental Team in the reporting month.

### **Complaint, Notification of Summons and Successful Prosecution**

No complaint, notification of summons and successful prosecution was received in the reporting month.

### **Future Key Issues**

Key issues to be considered in the coming month include:

- Properly store and label oils and chemicals on site;
- Chemical, chemical waste and waste management;
- Collection of construction waste should be carried out regularly;
- Properly maintain all drainage facilities and wheel washing facilities on site;
- Exposed slopes should be covered up properly if no temporary work will be conducted;
- Quieter powered mechanical equipment should be used;
- Suppress dust generated from excavation activities and haul road traffic; and
- Tree protective measures for all retained trees should be well maintained.

## 1 INTRODUCTION

### 1.1 Background

- 1.1.1. Tolo Highway and Fanling Highway are the expressways in the North East New Territories (NENT) connecting Sha Tin, Tai Po and Fanling. These highways form a vital part of the strategic Route 9, which links Hong Kong Island to the boundary at Shenzhen. At present, this section of Route 9 is a dual 3-lane carriageway. However, at several major interchanges along this section of Route 9, the highway is a dual-2 lane carriageway only. Severe congestion is a frequent occurrence during the peak periods, particularly in the Kowloon-bound direction.
- 1.1.2. The objective of the Project “Widening of Tolo Highway / Fanling Highway between Island House Interchange and Fanling” is to widen Tolo Highway and Fanling Highway to dual 4-lane carriageway in order to alleviate the current traffic congestion problems and to cope with the increasing transport demands to and from the urban areas and also cross boundary traffic.
- 1.1.3. The Project is a designated project and governed by an Environmental Permit (EP-324/2008) issued by the EPD on 23 December 2008. Subsequently, the EPD issued a Variation of Environmental Permit (EP-324/2008/A) (VEP) on 31 January 2012. The VEP (EP-324/2008/B) was subsequently granted on 17 March 2014 which superseded the previous EP (EP-324/2008/A).
- 1.1.4. The scope of the Project comprises mainly:-
  - (i) Widening of a 5.7 km section of Tolo Highway and 3.0 km section of Fanling Highway between Island House Interchange and Wo Hop Shek Interchange from the existing dual 3-lane to dual 4-lane, including construction of new vehicular bridges;
  - (ii) Widening of interchange sections at Island House Interchange, Tai Po North Interchange, and Lam Kam Road Interchange from dual 2-lane to dual 3-lane, except Sha Tin bound carriageway at Tai Po North Interchange, which is widened from 3-lane to 4-lane, including realignment of various slip roads;
  - (iii) Modification and reconstruction of highways, vehicular bridges, underpasses and footbridges.
- 1.1.5. The construction works for this Project will be delivered in 2 stages i.e. Stage 1 (between Island House Interchange and Tai Hang) and Stage 2 (between Tai Hang and Wo Hop Shek Interchange). Stage 2 would be implemented under two works contracts. Contract No. HY/2012/06 “Widening of Fanling Highway – Tai Hang to Wo Hop Shek Interchange” and the entrusted portion to CEDD under Contract No. CV/2012/09 “Liantang/Heung Yuen Wai Boundary Control Point Site Formation and Infrastructure Works – Contract 3”. This report focuses on Contract No. HY2012/06 “Widening of Fanling Highway – Tai Hang to Wo Hop Shek Interchange” in Stage 2 of the Project only.
- 1.1.6. Hyder-Arup-Black and Veatch Joint Venture (HABVJV) are appointed by Highways Department (HyD) as the consultants for the design and construction assignment for the Tolo project under Agreement No. CE 58/2000 Supplementary Agreement No. 3 (SA3) (i.e. the Engineer for the Contract).
- 1.1.7. China State Construction Engineering (Hong Kong) Ltd. (CSHK) was commissioned as the Contractor of the Contract.
- 1.1.8. AECOM Asia Co. Ltd. was commissioned by China State Construction Engineering (Hong Kong) Limited as the Environmental Team (ET) to undertake the Environmental Monitoring and Audit (EM&A) works for the Contract and Mott MacDonald Hong Kong Ltd. acts as the Independent Environmental Checker (IEC) for the Contract.
- 1.1.9. The construction phase of the Contract under the EP commenced on 21 November 2013.
- 1.1.10. According to the updated EM&A Manual of Stage 2 of the Project, there is a need of an EM&A programme including air quality and noise monitoring. The EM&A programme for Stage 2 of the Project commenced on 21 November 2013.

## 1.2 Scope of Report

1.2.1 This is the tenth monthly EM&A Report under the Contract No. HY/2012/06 “Widening of Fanling Highway – Tai Hang to Wo Hop Shek Interchange. This report presents a summary of the environmental monitoring and audit works, list of activities and mitigation measures proposed by the ET for the Contract in August 2014.

## 1.3 Project Organization

1.3.1 The project organization structure is shown in Appendix A. The key personnel contact names and numbers are summarized in Table 1.1.

**Table 1.1 Contact Information of Key Personnel**

Party	Position	Name	Telephone	Fax
<b>ER</b> (Hyder-Arup-Black & Veatch Joint Venture)	Chief Resident Engineer	Edwin Chung	6115 0818	2638 0950
<b>IEC</b> (Mott MacDonald Hong Kong Limited)	Independent Environmental Checker	Terence Kong	2828 5919	2827 1823
<b>Contractor</b> (China State Construction Engineering (Hong Kong) Limited)	Environmental Officer	Michael Tsang	9277 4956	2672 2501
		C C Chow	9679 6315	2672 2501
<b>ET</b> (AECOM Asia Company Limited)	ET Leader	Y W Fung	3922 9393	3922 9797

## 1.4 Summary of Construction Works

1.4.1 The construction phase for the Contract under the EP commenced on 21 November 2013.

1.4.2 Details of the construction works carried out by the Contractor in this reporting period are listed below:

- Site clearance
- Ground investigation
- Tree felling and transplanted
- Piling works
- Pipe laying
- Retaining wall construction
- Noise barrier construction
- Excavation
- Backfilling
- Drainage
- Temporary bridge construction



1.4.3 The Construction Programme is shown in Appendix B.

1.4.4 The general layout plan of the Project site showing the contract areas is shown in Figure 1.1.

1.4.5 The environmental mitigation measures implementation schedule are presented in Appendix C.

## **1.5 Summary of EM&A Programme Requirements**

1.5.1 The EM&A programme required environmental monitoring for air quality, noise and environmental site inspections for air quality, water quality, noise, waste management, ecology, and landscape and visual impact. The EM&A requirements for each parameter described in the following sections include:-

- All monitoring parameters;
- Monitoring schedules for the reporting month and forthcoming months;
- Action and Limit levels for all environmental parameters;
- Event / Action Plan;
- Environmental mitigation measures, as recommended in the Project EIA study final report; and
- Environmental requirement in contract documents.

## 2 AIR QUALITY MONITORING

### 2.1 Monitoring Requirements

2.1.1 In accordance with the updated EM&A Manual, baseline 1-hour and 24-hour TSP levels at one air quality monitoring station was established. Impact 1-hour TSP monitoring was conducted for at least three times every 6 days, while impact 24-hour TSP monitoring was carried out for at least once every 6 days. The Action and Limit level of the air quality monitoring is provided in Appendix D.

### 2.2 Monitoring Equipment

2.2.1 24-hour TSP air quality monitoring was performed using High Volume Sampler (HVS) located at each designated monitoring station. The HVS meets all the requirements of the updated EM&A Manual. Portable direct reading dust meters were used to carry out the 1-hour TSP monitoring. Brand and model of the equipment is given in Table 2.1.

**Table 2.1 Air Quality Monitoring Equipment**

Equipment	Brand and Model
Portable direct reading dust meter (1-hour TSP)	Sibata Digital Dust Monitor (Model No. LD-3 and LD-3B)
High Volume Sampler (24-hour TSP)	Tisch Total Suspended Particulate Mass Flow Controlled High Volume Air Sampler (Model No. TE-5170)

### 2.3 Monitoring Locations

2.3.1 The monitoring station was set up at the proposed location in accordance with updated EM&A Manual. Table 2.2 describes details of the monitoring station. The locations are shown in Figure 1.2a.

**Table 2.2 Locations of Impact Air Quality Monitoring Station**

Location	Monitoring Station
AM2 (SR2)	Fanling Government Secondary School

### 2.4 Monitoring Parameters and Frequency

2.4.1 Table 2.3 summarizes the monitoring parameters, frequency and duration of impact TSP monitoring.

**Table 2.3 Air Quality Monitoring Parameters and Frequency**

Parameter	Frequency
24-hour TSP	Once every 6 days
1-hour TSP	3 times every 6 days while the highest dust impact was expected

## 2.5 Monitoring Methodology

### 2.5.1 24-hour TSP Monitoring

- (a) The HVS was installed in the vicinity of the air sensitive receivers. The following criteria were considered in the installation of the HVS.
- (i) A horizontal platform with appropriate support to secure the sampler against gusty wind was provided.
  - (ii) The distance between the HVS and any obstacles, such as buildings, was at least twice the height that the obstacle protrudes above the HVS.
  - (iii) A minimum of 2 meters separation from walls, parapets and penthouse for rooftop sampler.
  - (iv) A minimum of 2 meters separation from any supporting structure, measured horizontally.
  - (v) No furnace or incinerator flues nearby.
  - (vi) Airflow around the sampler was unrestricted.
  - (vii) Permission was obtained to set up the samplers and access to the monitoring stations.
  - (viii) A secured supply of electricity was obtained to operate the samplers.
  - (ix) The sampler was located more than 20 meters from any dripline.
  - (x) Any wire fence and gate, required to protect the sampler, did not obstruct the monitoring process.
  - (xi) Flow control accuracy was kept within  $\pm 2.5\%$  deviation over 24-hour sampling period.
- (b) Preparation of Filter Papers
- (i) Glass fibre filters, G810 were labelled and sufficient filters that were clean and without pinholes were selected.
  - (ii) All filters were equilibrated in the conditioning environment for 24 hours before weighing. The conditioning environment temperature was around 25 °C and not variable by more than  $\pm 3$  °C; the relative humidity (RH) was < 50% and not variable by more than  $\pm 5\%$ . A convenient working RH was 40%.
  - (iii) All filter papers were prepared and analysed by ALS Technichem (HK) Pty Ltd., which is a HOKLAS accredited laboratory and has comprehensive quality assurance and quality control programmes.
- (c) Field Monitoring
- (i) The power supply was checked to ensure the HVS works properly.
  - (ii) The filter holder and the area surrounding the filter were cleaned.
  - (iii) The filter holder was removed by loosening the four bolts and a new filter, with stamped number upward, on a supporting screen was aligned carefully.
  - (iv) The filter was properly aligned on the screen so that the gasket formed an airtight seal on the outer edges of the filter.
  - (v) The swing bolts were fastened to hold the filter holder down to the frame. The pressure applied was sufficient to avoid air leakage at the edges.
  - (vi) Then the shelter lid was closed and was secured with the aluminum strip.
  - (vii) The HVS was warmed-up for about 5 minutes to establish run-temperature conditions.
  - (viii) A new flow rate record sheet was set into the flow recorder.
  - (ix) On site temperature and atmospheric pressure readings were taken and the flow rate of the HVS was checked and adjusted at around 1.1 m<sup>3</sup>/min, and complied with the range specified in the updated EM&A Manual (i.e. 0.6-1.7 m<sup>3</sup>/min).
  - (x) The programmable digital timer was set for a sampling period of 24 hrs, and the starting time, weather condition and the filter number were recorded.
  - (xi) The initial elapsed time was recorded.
  - (xii) At the end of sampling, on site temperature and atmospheric pressure readings were taken and the final flow rate of the HVS was checked and recorded.
  - (xiii) The final elapsed time was recorded.

- (xiv) The sampled filter was removed carefully and folded in half length so that only surfaces with collected particulate matter were in contact.
  - (xv) It was then placed in a clean plastic envelope and sealed.
  - (xvi) All monitoring information was recorded on a standard data sheet.
  - (xvii) Filters were then sent to ALS Technichem (HK) Pty Ltd. for analysis.
- (d) Maintenance and Calibration
- (i) The HVS and its accessories were maintained in good working condition, such as replacing motor brushes routinely and checking electrical wiring to ensure a continuous power supply.
  - (ii) 5-point calibration of the HVS was conducted using TE-5025A Calibration Kit prior to the commencement of baseline monitoring. Bi-monthly 5-point calibration of the HVS will be carried out during impact monitoring.
  - (iii) Calibration certificate of the HVSs are provided in Appendix E.

## 2.5.2 1-hour TSP Monitoring

### (a) Measuring Procedures

The measuring procedures of the 1-hour dust meter were in accordance with the Manufacturer's Instruction Manual as follows:-

- (i) Turn the power on.
- (ii) Close the air collecting opening cover.
- (iii) Push the "TIME SETTING" switch to [BG].
- (iv) Push "START/STOP" switch to perform background measurement for 6 seconds.
- (v) Turn the knob at SENSI ADJ position to insert the light scattering plate.
- (vi) Leave the equipment for 1 minute upon "SPAN CHECK" is indicated in the display.
- (vii) Push "START/STOP" switch to perform automatic sensitivity adjustment. This measurement takes 1 minute.
- (viii) Pull out the knob and return it to MEASURE position.
- (ix) Push the "TIME SETTING" switch the time set in the display to 3 hours.
- (x) Lower down the air collection opening cover.
- (xi) Push "START/STOP" switch to start measurement.

### (b) Maintenance and Calibration

- (i) The 1-hour TSP meter was calibrated at 1-year intervals against a continuous particulate TEOM Monitor, Series 1400ab. Calibration certificates of the Laser Dust Monitors are provided in Appendix E.
- (ii) 1-hour validation checking of the TSP meter against HVS is carried out yearly at the air quality monitoring locations.

## 2.6 Monitoring Schedule for the Reporting Month

2.6.1 The schedule for environmental monitoring in August 2014 is provided in Appendix F.

## 2.7 Results and Observations

2.7.1 The monitoring results for 1-hour TSP and 24-hour TSP are summarized in Table 2.4 and 2.5 respectively. Detailed impact air quality monitoring results are presented in Appendix G.

**Table 2.4 Summary of 1-hour TSP Monitoring Results in the Reporting Period**

Location	Average ( $\mu\text{g}/\text{m}^3$ )	Range ( $\mu\text{g}/\text{m}^3$ )	Action Level ( $\mu\text{g}/\text{m}^3$ )	Limit Level ( $\mu\text{g}/\text{m}^3$ )
<b>AM2</b> (Fanling Government Secondary School)	70.6	61.7 – 78.6	317.8	500

**Table 2.5 Summary of 24-hour TSP Monitoring Results in the Reporting Period**

Location	Average ( $\mu\text{g}/\text{m}^3$ )	Range ( $\mu\text{g}/\text{m}^3$ )	Action Level ( $\mu\text{g}/\text{m}^3$ )	Limit Level ( $\mu\text{g}/\text{m}^3$ )
<b>AM2</b> (Fanling Government Secondary School)	21.6	14.6 – 31.2	200.7	260

- 2.7.2 The major dust source during the monitoring was mainly from nearby traffic emission.
- 2.7.3 All 1-hour and 24-hour TSP results were below the Action and Limit Level at all monitoring locations in the reporting month.
- 2.7.4 The event action plan is annexed in Appendix J.
- 2.7.5 Weather information including wind speed and wind direction is annexed in Appendix H. The information was obtained from the Hong Kong Observatory Tai Po and Tai Mei Tuk Automatic Weather Stations.

### 3 NOISE MONITORING

#### 3.1 Monitoring Requirements

3.1.1 In accordance with the EM&A Manual, impact noise monitoring was conducted for at least once per week during the construction phase of the Contract. The Action and Limit level of the noise monitoring is provided in Appendix D.

#### 3.2 Monitoring Equipment

3.2.1 Noise monitoring was performed using sound level meter at each designated monitoring station. The sound level meters deployed comply with the International Electrotechnical Commission Publications (IEC) 651:1979 (Type 1) and 804:1985 (Type 1) specifications. Acoustic calibrator was deployed to check the sound level meters at a known sound pressure level. Brand and model of the equipment is given in Table 3.1.

**Table 3.1 Noise Monitoring Equipment**

Equipment	Brand and Model
Integrated Sound Level Meter	Rion NL-31, B&K 2238, B&K 2250
Acoustic Calibrator	Rion NC-73

#### 3.3 Monitoring Locations

3.3.1 Monitoring stations M2 and M3 were set up at the proposed locations in accordance with updated EM&A Manual. Figure 1.2a-b shows the locations of the monitoring stations. Table 3.2 describes the details of the monitoring stations.

**Table 3.2 Locations of Impact Noise Monitoring Stations**

Monitoring Station	Location	Description
M2	West Tai Wo	1.2m from the ground floor free-field of the Residential
M3	Fanling Government Secondary School	1m from the exterior of the roof top façade of the school

#### 3.4 Monitoring Parameters and Frequency

3.4.1 Table 3.3 summarizes the monitoring parameters, frequency and duration of impact noise monitoring.

**Table 3.3 Noise Monitoring Parameters, Frequency and Duration**

Parameter	Frequency
30-mins measurement at each monitoring station between 0700 and 1900 on normal weekdays. $L_{eq}$ , $L_{10}$ and $L_{90}$ would be recorded.	At least once per week

### 3.5 Monitoring Methodology

#### 3.5.1 Monitoring Procedure

- (a) Façade measurement was made at monitoring station M3, while free-field measurement was made at monitoring station M2.
- (b) The sound level meter was set on a tripod at a height of 1.2 m above the ground for free-field measurements at monitoring station M2.
- (c) The battery condition was checked to ensure the correct functioning of the meter.
- (d) Parameters such as frequency weighting, the time weighting and the measurement time were set as follows:-
  - (i) frequency weighting: A
  - (ii) time weighting: Fast
  - (iii) time measurement:  $L_{eq(30\text{-minutes})}$  during non-restricted hours i.e. 07:00 – 1900 on normal weekdays;  $L_{eq(5\text{-minutes})}$  during restricted hours i.e. 19:00 – 23:00 and 23:00 – 07:00 of normal weekdays, whole day of Sundays and Public Holidays
- (e) Prior to and after each noise measurement, the meter was calibrated using the acoustic calibrator for 94dB(A) at 1000 Hz. If the difference in the calibration level before and after measurement was more than 1 dB(A), the measurement would be considered invalid and repeat of noise measurement would be required after re-calibration or repair of the equipment.
- (f) During the monitoring period, the  $L_{eq}$ ,  $L_{10}$  and  $L_{90}$  were recorded. In addition, site conditions and noise sources were recorded on a standard record sheet.
- (g) Noise measurement was paused during periods of high intrusive noise (e.g. dog barking, helicopter noise) if possible. Observations were recorded when intrusive noise was unavoidable.
- (h) Noise monitoring was cancelled in the presence of fog, rain, wind with a steady speed exceeding 5m/s, or wind with gusts exceeding 10m/s.

#### 3.5.2 Maintenance and Calibration

- (a) The microphone head of the sound level meter was cleaned with soft cloth at regular intervals.
- (b) The meter and calibrator were sent to the supplier or HOKLAS laboratory to check and calibrate at yearly intervals.
- (c) Calibration certificates of the sound level meters and acoustic calibrators are provided in Appendix E.

### 3.6 Monitoring Schedule for the Reporting Month

3.6.1 The schedule for environmental monitoring in August 2014 is provided in Appendix F.

### 3.7 Monitoring Results

3.7.1 The monitoring results for construction noise are summarized in Table 3.4 and the monitoring data is provided in Appendix I.

**Table 3.4 Summary of Construction Noise Monitoring Results in the Reporting Period**

	Average, dB(A), $L_{eq(30\text{ mins})}$	Range, dB(A), $L_{eq(30\text{ mins})}$	Limit Level, dB(A), $L_{eq(30\text{ mins})}$
M2*	69.7	66.8 – 72.6	75
M3#	65.2	61.1 – 67.5	65/70

\*+3dB(A) Façade correction included

# Limit Level of 70dB(A) applies to education institutes while 65dB(A) applies during school examination period.

- 3.7.2 No Action or Limit Level exceedance of construction noise was recorded in the reporting month. No noise complaints related to 0700 – 1900 hours on normal weekdays was received and followed by Environmental Team in the reporting month.
- 3.7.3 Major noise sources during noise monitoring in the reporting month were mainly road traffic noise.
- 3.7.4 The event action plan is annexed in Appendix J.



## **4 ENVIRONMENTAL SITE INSPECTION AND AUDIT**

### **4.1 Site Inspection**

4.1.1 Site Inspections were carried out on a weekly basis to monitor the implementation of proper environmental pollution control and mitigation measures for the Contract. In the reporting month, 5 site inspections were carried out respectively on 5, 14, 19 and 26 August 2014 for the Contract. While no specific observation was recorded, recommendations on remedial actions were given to the Contractor for precautionary purpose.

4.1.2 The environmental site inspections summaries are provided in Appendix K.

4.1.3 Particular observations during the site inspections are described below:

#### ***Air Quality***

4.1.4 No adverse observation was identified in the reporting month.

#### ***Noise***

4.1.5 The Contractor should further wrap the upper part of the breaker with absorptive materials to minimize noise generation.

#### ***Water Quality***

4.1.6 No adverse observation was identified in the reporting month.

#### ***Chemical and Waste Management***

4.1.7 The Contractor was reminded to use absorptive materials to soak leaked oil, if any, when maintaining the power pack. (Reminder)

#### ***Landscape and Visual Impact***

4.1.8 No adverse observation was identified in the reporting month.

#### ***Miscellaneous***

4.1.9 No adverse observation was identified in the reporting month.

## 4.2 Advice on the Solid and Liquid Waste Management Status

- 4.2.1 The Contractor has registered as chemical waste producers for the Contract. C&D material sorting was carried out on site. Sufficient numbers of receptacles were available for general refuse collection.
- 4.2.2 As advised by the Contractor, 1,515m<sup>3</sup> of inert C&D material was disposed of as public fill to Tuen Mun 38 (of which 0m<sup>3</sup> was broken concrete), while 80m<sup>3</sup> of general refuse was disposed of at NENT landfill. 73kg of paper/cardboard packaging, 0kg of plastics and 0kg of metals were collected by recycling contractors in the reporting month. 735m<sup>3</sup> of inert C&D materials was reused on site. 95m<sup>3</sup> of inert C&D materials was reused in other projects. 685m<sup>3</sup> of inert C&D materials was disposed of as public fill at NENT. 0kg of chemical wastes was collected by licensed contractors in the reporting period.
- 4.2.3 The actual amounts of different types of waste generated by the activities of the Project in the reporting month are shown in Table 4.1.

**Table 4.1 Summary of Waste Flow Table**

Waste Type	Actual Amount	Disposal/Reuse Locations
Inert C&D materials	1,515m <sup>3</sup> (of which 0m <sup>3</sup> was broken concrete)	Tuen Mun 38
General refuse	80m <sup>3</sup>	NENT Landfill
Paper/cardboard packaging	73kg	Recycling Contractors
Plastics	0kg	Recycling Contractors
Metals	0kg	Recycling Contractors
C&D materials reused on site	735m <sup>3</sup>	Site Area
C&D materials reused in other projects	95m <sup>3</sup>	Other projects
C&D materials reused in NENT for backfilling	685m <sup>3</sup>	NENT Landfill
Chemical wastes	0kg	Licensed Contractors

- 4.2.4 The Contractor was advised to maintain on site waste sorting and recording system and maximize reuse / recycle of C&D wastes.

## 4.3 Environmental Licenses and Permits

- 4.3.1 The environmental licenses and permits for Stage 2 of the Project and valid in the reporting month is summarized in Table 4.2.

**Table 4.2 Summary of Environmental Licensing and Permit Status**

Statutory Reference	License/ Permit	License or Permit No.	Valid Period		License/ Permit Holder	Remarks
			From	To		
EIAO	Environmental Permit	EP-324/2008/B	17/03/2014	N/A	HyD	The VEP (EP-324/2008/B) was subsequently granted on 17 March 2014 which superseded the previous EP (EP-324/2008/A).

Statutory Reference	License/ Permit	License or Permit No.	Valid Period		License/ Permit Holder	Remarks
			From	To		
WPCO	Discharge License (Site)	WT00017159-2013	18/09/2013	30/09/2018	CSHK	--
WDO	Chemical Waste Producer Registration	5213-722-C3822-01	5/09/2013	N/A	CSHK	Chemical waste produced in Contract HY/2012/06
WDO	Billing Account for Disposal of Construction Waste	7009328	08/09/2009	N/A	CSHK	Waste disposal in Contract HY/2008/09
		GW-RN0259-14	17/04/2014	19/09/2014	CSHK	Tree Felling at Fanling Highway between CH23.6 and CH24.3 (South Bound)
		GW-RN0291-14	09/05/2014	06/11/2014	CSHK	Grouting Works at SA344
		GW-RN0345-14	08/06/2014	16/11/2014	CSHK	Concreting Works at SA320 (South Bound)
		GW-RN0346-14	01/06/2014	02/11/2014	CSHK	Tree Felling at Fanling Highway near Hong Lok Yuen (South Bound)
		GW-RN0356-14	09/06/2014	02/12/2014	CSHK	Zone 2 Dismantling of Sign Gantries (South Bound)
		GW-RN0365-14	15/06/2014	30/11/2014	CSHK	Zone 4 Dismantling of Sign Gantries near Wo Hop Shek Bridge (North Bound)
		GW-RN0462-14	27/07/2014	28/12/2014	CSHK	Zones 1 & 2 Loading and Unloading at Fanling Highway between Yuen Leng and Hong Lok Yuen (South Bound)
		GW-RN0486-14	14/08/2014	31/12/2014	CSHK	Zone 4 Grouting Works at SA340 (South Bound)
		GW-RN0499-14	17/08/2014	28/12/2014	CSHK	Zone 4 Loading and Unloading at Fanling Highway between Ch.23.4 and Ch. 23.8 (North Bound)

#### **4.4 Implementation Status of Environmental Mitigation Measures**

4.4.1 A summary of the Implementation Schedule of Environmental Mitigation Measures (EMIS) is presented in Appendix C.

#### **4.5 Summary of Exceedances of the Environmental Quality Performance Limit**

4.5.1 All 1-hour and 24-hour TSP monitoring results complied with the Action / Limit Levels in the reporting period.

4.5.2 No Action or Limit Level exceedance of construction noise was recorded in the reporting month, since no noise complaints related to 0700 – 1900 hours on normal weekdays was received and followed by Environmental Team in the reporting month.

#### **4.6 Summary of Complaints, Notification of Summons and Successful Prosecutions**

4.6.1 The Environmental Complaint Handling Procedure is annexed in Figure 4.1.

4.6.2 No complaint, notification of summons and successful prosecution was received in the reporting month.

4.6.3 Statistics on complaints, notifications of summons and successful prosecutions are summarized in Appendix L.

## **5 FUTURE KEY ISSUES**

### **5.1 Construction Programme for the Coming Months**

5.1.1 The major construction works for the Contract in September 2014 will be:-

- Site clearance
- Ground investigation
- Tree felling and transplantation
- Piling works
- Pipe laying
- Retaining wall construction
- Noise barrier construction
- Excavation
- Backfilling
- Drainage
- Temporary bridge construction
- Demolition of existing footbridge

### **5.2 Key Issues for the Coming Month**

5.2.1 Key issues to be considered in September 2014:-

- Properly store and label oils and chemicals on site;
- Chemical, chemical waste and waste management;
- Collection of construction waste should be carried out regularly;
- Properly maintain all drainage facilities and wheel washing facilities on site;
- Exposed slopes should be covered up properly if no temporary work will be conducted;
- Quieter powered mechanical equipment should be used;
- Suppress dust generated from excavation activities and haul road traffic; and
- Tree protective measures for all retained trees should be well maintained.

### **5.3 Monitoring Schedule for the Coming Month**

5.3.1 The tentative schedule for environmental monitoring in September 2014 is provided in Appendix F.

## **6 CONCLUSIONS AND RECOMMENDATIONS**

### **6.1 Conclusions**

- 6.1.1 The construction phase and EM&A programme of the Contract commenced on 21 November 2013.
- 6.1.2 All 1-hour and 24-hour TSP monitoring results complied with the Action / Limit Levels in the reporting period.
- 6.1.3 No Action or Limit Level exceedance of construction noise was recorded in the reporting month, since no noise complaints related to 0700 – 1900 hours on normal weekdays was received and followed by Environmental Team in the reporting month.
- 6.1.4 4 environmental site inspections were carried out in August 2014. Recommendations on remedial actions were given to the Contractors for the deficiencies identified during the site audits.
- 6.1.5 No complaint, notification of summons and successful prosecution was received in the reporting month.

### **6.2 Recommendations**

- 6.2.1 According to the environmental site inspection performed in the reporting month, the following recommendations on remedial actions were provided to the Contractor for precautionary purpose:

#### ***Air Quality Impact***

- All vehicles should be washed to remove any dusty materials before leaving the site.
- Haul roads should be sufficiently dampened to minimize fugitive dust generation.
- Wheel washing facilities should be properly maintained to ensure properly functioning.

#### ***Construction Noise Impact***

- Noisy operations should be oriented to a direction away from sensitive receivers as far as possible.

#### ***Water Quality Impact***

- Stagnant water accumulated in drip trays should be removed.
- Silt accumulated at public drain should be cleaned up.
- Silty effluent should be treated/desilted before discharged. Untreated effluent should be prevented from entering public drain channel.

#### ***Chemical and Waste Management***

- C&D material should be sorted and removed timely.
- All plants on site should be properly maintained to prevent oil leakage.
- Oil stains on soil surface and empty chemical containers should be cleared and disposed of as chemical waste.

#### ***Landscape and Visual Impact***

- All retained trees should be properly fenced off at the works area.

---

---

## FIGURES

---

---

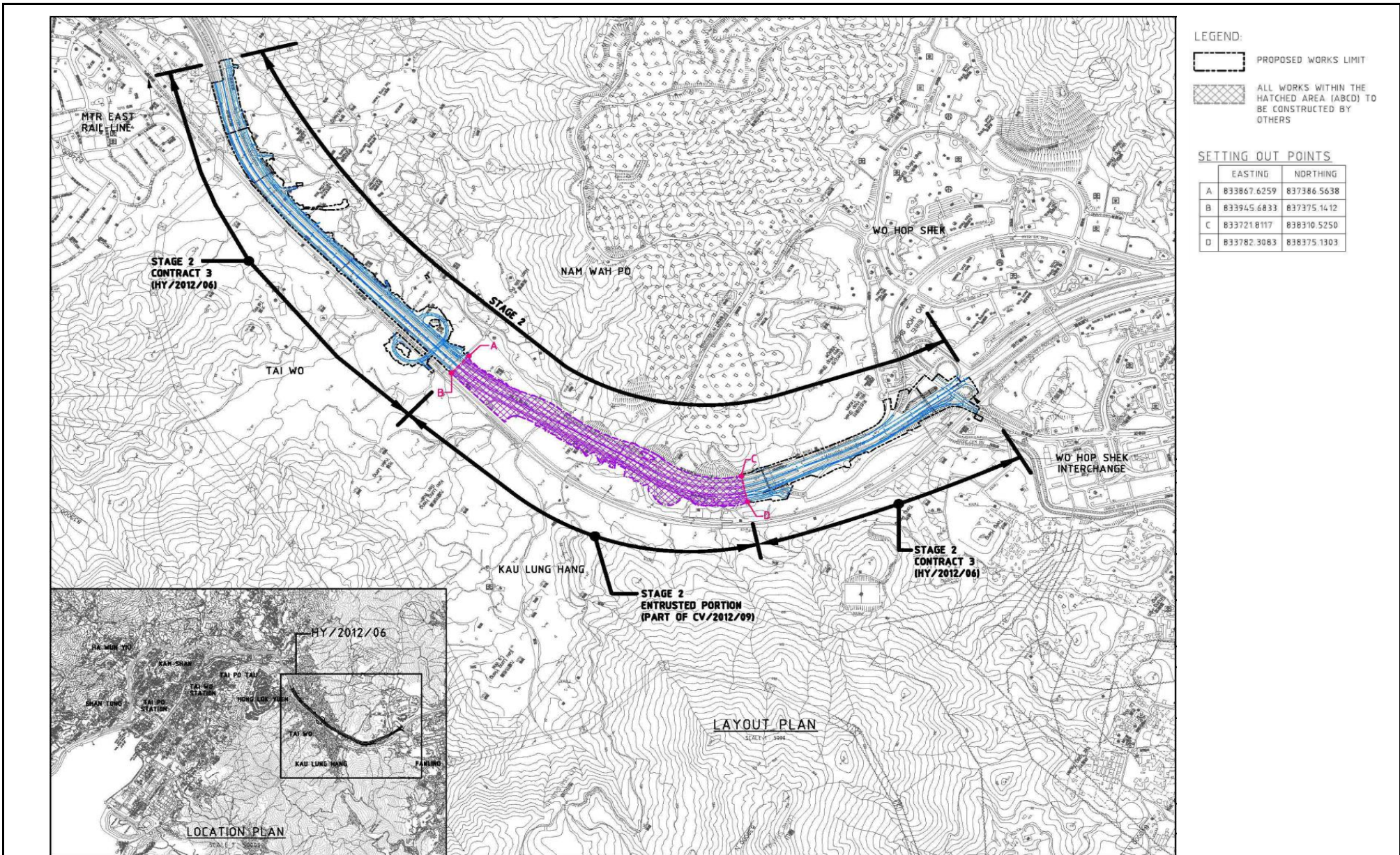

This Drawing has been prepared for the use of AECOM's client. It may not be used, modified, reproduced or relied upon by third parties, except as agreed by AECOM or as required by law. AECOM accepts no responsibility, and denies any liability whatsoever, to any party that uses or relies on this drawing without AECOM's express written consent.

CONTRACT NO. HY/2012/06  
 WIDENING OF FANLING HIGHWAY  
 - TAI HANG TO WO HOP SHEK INTERCHANGE



Layout Plan

Date: Dec 2013

Figure 1.1



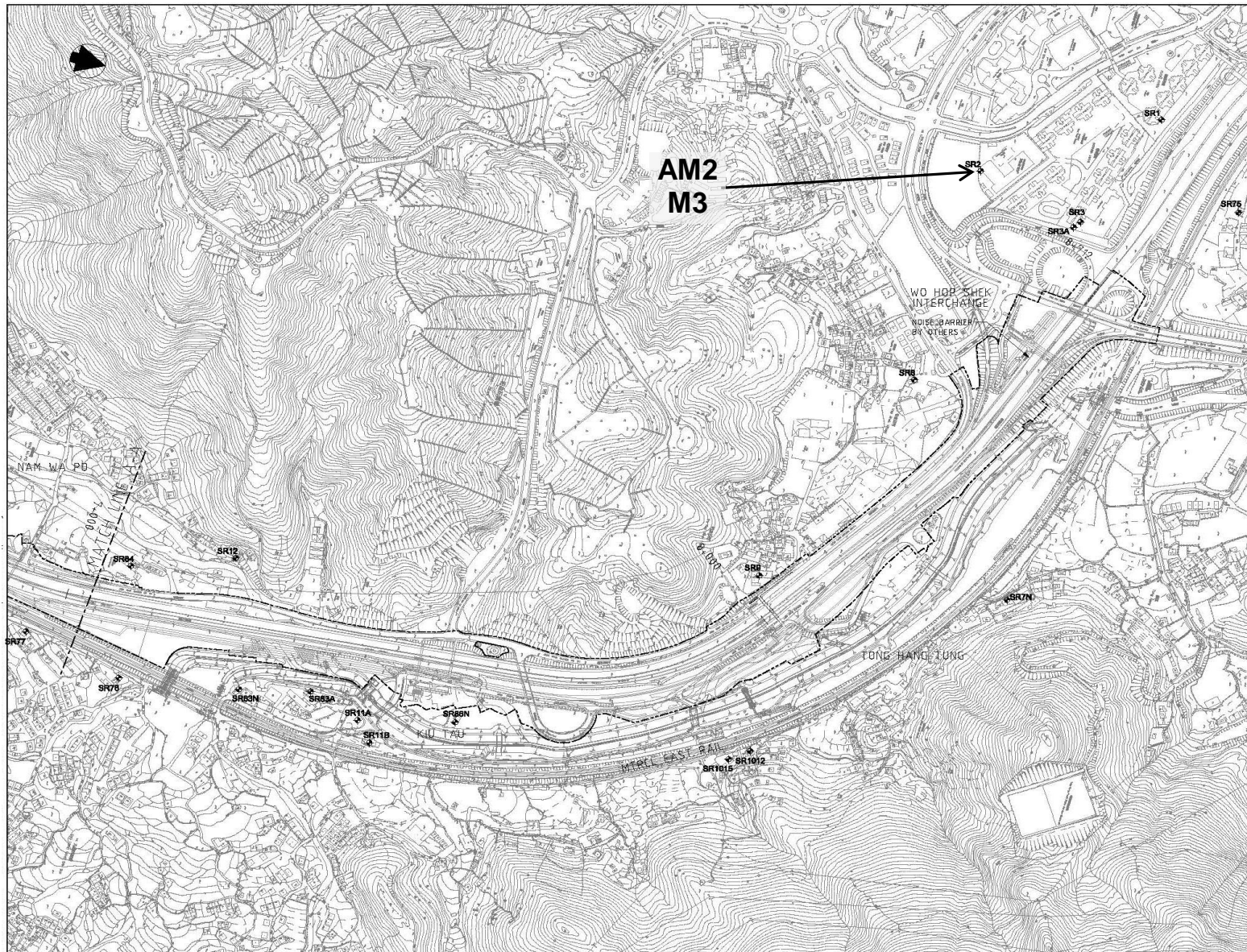

This Drawing has been prepared for the use of AECOM's client. It may not be used, modified, reproduced or relied upon by third parties, except as agreed by AECOM or as required by law. AECOM accepts no responsibility, and denies any liability whatsoever, to any party that uses or relies on this drawing without AECOM's express written consent.

CONTRACT NO. HY/2012/06  
 WIDENING OF FANLING HIGHWAY  
 - TAI HANG TO WO HOP SHEK INTERCHANGE



Locations of Monitoring Station

Date: Dec 2013

Figure 1.2a

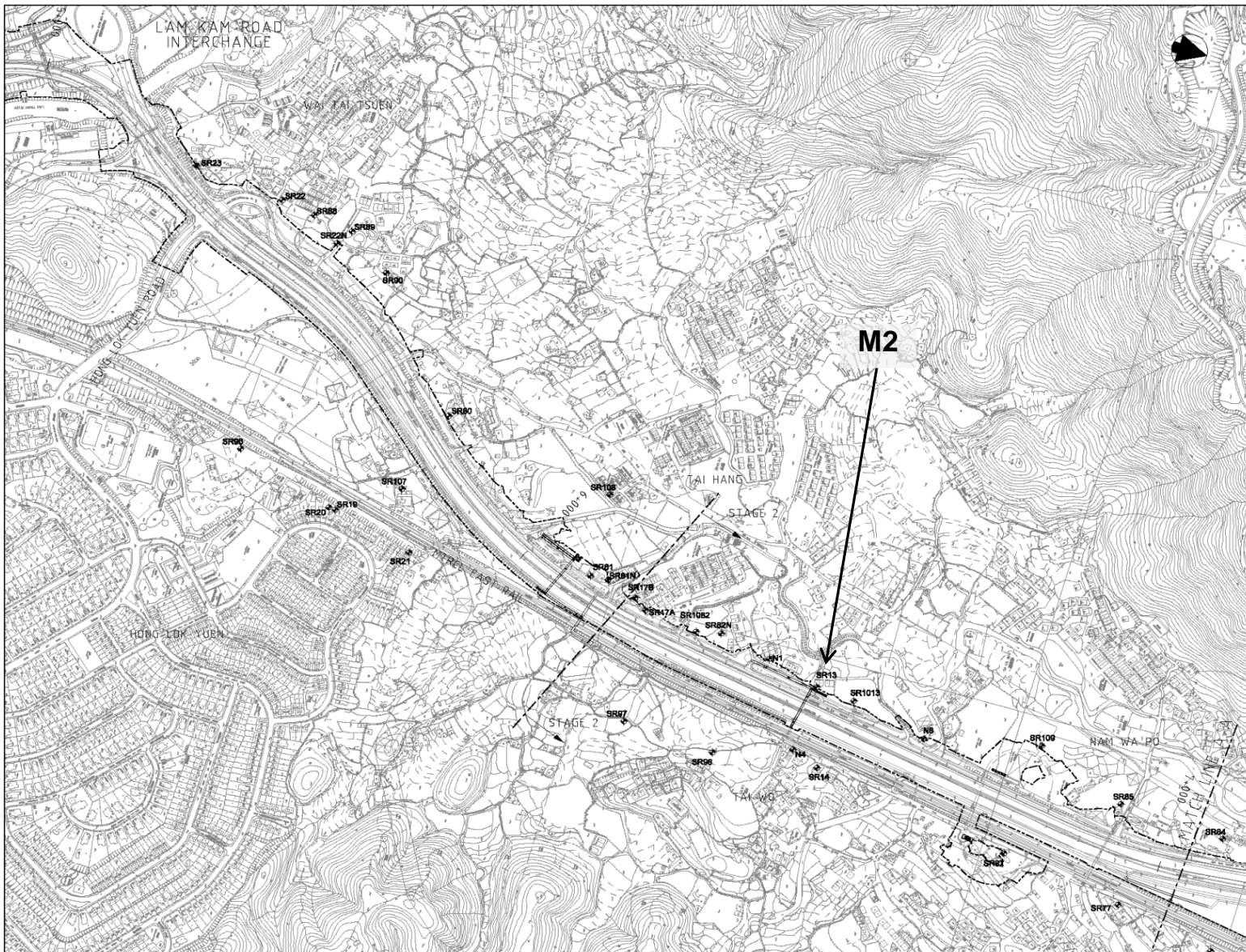

This Drawing has been prepared for the use of AECOM's client. It may not be used, modified, reproduced or relied upon by third parties, except as agreed by AECOM or as required by law. AECOM accepts no responsibility, and denies any liability whatsoever, to any party that uses or relies on this drawing without AECOM's express written consent.

CONTRACT NO. HY/2012/06  
 WIDENING OF FANLING HIGHWAY  
 - TAI HANG TO WO HOP SHEK INTERCHANGE



Locations of Monitoring Station

Date: Dec 2013

Figure 1.2b

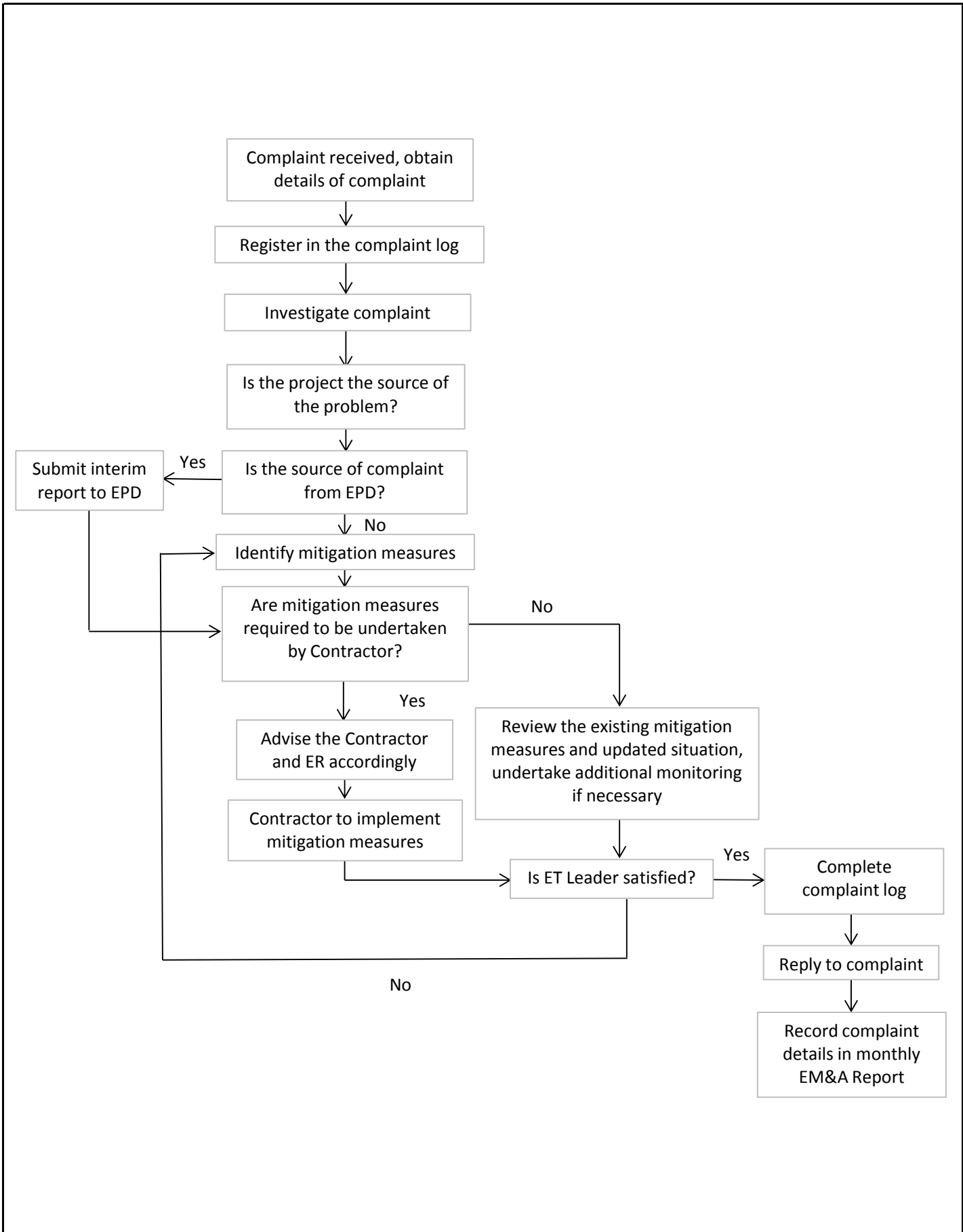

This Drawing has been prepared for the use of AECOM's client. It may not be used, modified, reproduced or relied upon by third parties, except as agreed by AECOM or as required by law. AECOM accepts no responsibility, and denies any liability whatsoever, to any party that uses or relies on this drawing without AECOM's express written consent.

CONTRACT NO. HY/2012/06  
 WIDENING OF FANLING HIGHWAY  
 - TAI HANG TO WO HOP SHEK INTERCHANGE



Environmental Complaint Handling Procedure

---

---

**APPENDIX A  
PROJECT ORGANIZATION STRUCTURE**

---

---

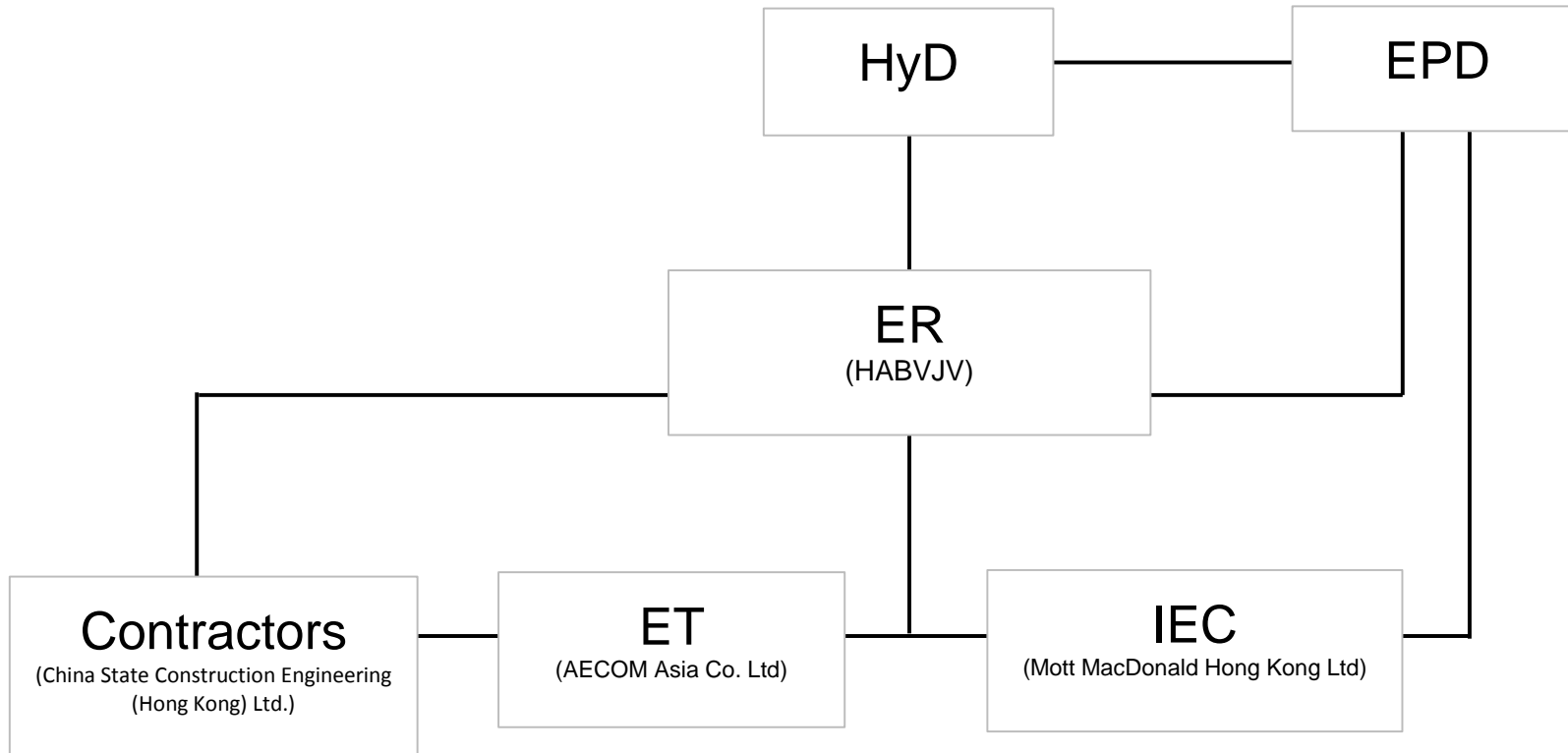

This Drawing has been prepared for the use of AECOM's client. It may not be used, modified, reproduced or relied upon by third parties, except as agreed by AECOM or as required by law. AECOM accepts no responsibility, and denies any liability whatsoever, to any party that uses or relies on this drawing without AECOM's express written consent.

CONTRACT NO. HY/2012/06  
 WIDENING OF FANLING HIGHWAY  
 - TAI HANG TO WO HOP SHEK INTERCHANGE



Project Organization Structure

---

---

**APPENDIX B  
CONSTRUCTION PROGRAMMES**

---

---

Activity ID	Activity Name	Duration % Complete	Remaining Duration	Original Duration	Start	Finish	Total Float	2014			
								Aug	Sep	Oct	Nov
<b>Contract Condition</b>											
<b>General</b>											
<b>Contract Condition</b>											
<b>Contract Condition</b>											
POSSA310	Site Area SA 310 (395d)	0%	0	0	20-Aug-14*		-4		◆ Site Area SA 310 (395d)		
POSSA320	Site Area SA320 (0d)	0%	0	0	25-Aug-14*		0		◆ Site Area SA320 (0d)		
POSSA323	Site Area SA323 (360d)	0%	0	0	30-Sep-14*		0		◆ Site Area SA323 (360d)		
POSSA323A	Site Area SA323A (360d) (not required)	0%	0	0	20-Aug-14*		-38		◆ Site Area SA323A (360d) (not required)		
POSSA323B	Site Area SA323B (360d)	0%	0	0	29-Aug-14*		0		◆ Site Area SA323B (360d)		
POSSA325	Site Area SA325 (180d)	0%	0	0	25-Aug-14*		0		◆ Site Area SA325 (180d)		
POSSA326	Site Area SA326 (180d)	0%	0	0	25-Aug-14*		0		◆ Site Area SA326 (180d)		
POSSA328	Site Area SA328 (90d)	0%	0	0	29-Aug-14*		0		◆ Site Area SA328 (90d)		
Z1.1000	Instruction by The Engineer to Commence Work (Section Subject	0%	0	0		14-Sep-14	0		◆ 14-Sep-14* Instruction by The Engineer to Commence Work (Section		
<b>Partial Possession Status</b>											
<b>Contract Condition</b>											
<b>Contract Condition</b>											
POSSA320-140	SA320/ 323	0%	0	0	25-Aug-14		-8		◆ SA320/ 323		
POSSA320-180	SA320/ 326	0%	0	0	25-Aug-14		-112		◆ SA320/ 326		
<b>ZONE 1 (Ch. 5640 to 5880)</b>											
<b>Noise Barrier Along TWSR-West and Laying New Utilities</b>											
<b>Site Clearance &amp; Demolition of Existing Structure</b>											
<b>General</b>											
ADVZ10100	Site clearance (Additional Transplant - pending for VO)	6.67%	28	30	30-May-14 A	22-Sep-14	58				
<b>NB42 (Ch.5640-5740)-TWSR West Side</b>											
<b>Noise Barrier Works</b>											
NB00110	NB42 (Ch5640-5740) - Footing & Wall Structure	0%	45	45	20-Oct-14	10-Dec-14	136				
<b>DSD Southern Trunk Sewer, Water Main Fire Main Works</b>											
TSZ10100	Sheet Piling & Excavation (~5m below ground) (along NB42)	0%	21	21	23-Sep-14	18-Oct-14	121				
TSZ10130	Watermain installation (along NB42)	0%	30	30	20-Oct-14	22-Nov-14	121				
<b>NB42A (Ch.5750-5810)-TWSR West Side</b>											
<b>Noise Barrier Works</b>											
NB00190	NB42A (Ch5750-5810) - Footing & Wall Structure	0%	30	30	16-Oct-14	19-Nov-14	58				
<b>DSD Southern Trunk Sewer, Water Main Fire Main Works</b>											
TSZ10150	Sheet Piling & Excavation (~5m below ground) (along NB42A)	0%	18	18	23-Sep-14	15-Oct-14	58				
<b>ZONE 2 (Ch. 5880 to 6930)</b>											
<b>Noise Barrier Along TWSR-West and Laying New Utilities</b>											
<b>Site Clearance &amp; Demolition of Existing Structure</b>											
<b>Demolition Work</b>											
Z2.P2N.1242	Pending for design brief from Villager/ Engineer	90%	3	30	01-Jan-14 A	22-Aug-14	-142				
Z2.P2N.1245	Method statement submission/ approval	0%	60	60	23-Aug-14	04-Nov-14	-142				
Z2.P2N.1250	Construction of proposed SHRINE	0%	165	165	05-Nov-14	02-Jun-15	1019				
Z2.P2N.1260	Demolition of existing SHRINE	0%	30	30	05-Nov-14	09-Dec-14	-142				
Z2.P2N.1270	Condition survey	0%	5	5	24-Sep-14	30-Sep-14	90				
Z2.P2N.1300	Condition survey	0%	6	6	23-Sep-14	30-Sep-14	-32				
Z2.P2N.1310	Existing trees felling	0%	25	25	30-Sep-14	30-Oct-14	-32				
Z2.P2N.1320	Demolition of villiage houses	0%	26	26	30-Sep-14	31-Oct-14	-32				
<b>NB48 (Ch.5995-6120)-TWSR West Side</b>											
<b>Noise Barrier Works</b>											
NB00360	NB48 (NB48/1-5 up to THFB) piling (0.19m -54no)	70.37%	24	81	14-Jun-14 A	17-Sep-14	-20				
<b>DSD Southern Trunk Sewer, Water Main Fire Main Works</b>											
TSZ10400	Sheet Piling & Excavation (~5m below ground) (along NB48, 0-60m)	0%	21	21	18-Sep-14	14-Oct-14	-20				
TSZ10410	DSD Trunk Sewer laying (along NB48, 0-60m)	0%	18	18	15-Oct-14	04-Nov-14	-20				
TSZ10420	Backfill up to NB48, 0-60m footing level	0%	32	32	05-Nov-14	11-Dec-14	-20				
<b>NB49 (Ch.6145-6215)-TWSR West Side</b>											
<b>Noise Barrier Works</b>											
NB00485	NB49 - Pre-drilling	0%	50	50	01-Nov-14	31-Dec-14	-32				
<b>NB49B (Ch.6215-6235)-TWSR West Side</b>											
<b>Noise Barrier Works</b>											
NB00545	NB49B - Pre-drilling (Deleted notified in July-14, VO issued	0%	22	22	20-Aug-14	15-Sep-14	-80				
NB00550	NB49B piling (0.19m -22no) (Deleted notified in July-14, VO	0%	33	33	16-Sep-14	25-Oct-14	-80				
<b>NB54 (Ch.6240-6280)-TWSR West Side</b>											
<b>Noise Barrier Works</b>											
NB00605	NB54 - ID2-1 Pre-drilling (Deleted notified on 14-5, VO issued	0%	0	0	16-Sep-14	16-Sep-14	-71				
<b>NB57 (Ch.6365-6445)-TWSR West Side</b>											
<b>Noise Barrier Works</b>											
NB00805	Pending for design information (RFI/00088)	0%	14	5	17-Jul-14 A	02-Sep-14	-173				
NB00810	NB57 piling (0.19m -82no)	0%	123	123	03-Sep-14	30-Jan-15	-140				
<b>NB58 (Ch.6445-6480)-TWSR West Side</b>											
<b>Noise Barrier Works</b>											
NB00870	NB58 -Pre-drilling (2 nos after remove Hse 103 wall)	0%	179	22	30-Jul-14 A	31-Mar-15	-39				

Project ID: DWP Rev 01 (1408)  
 Layout: 3 Month Rolling Program  
 Page 1 of 4

**Contract No. HY/2012/06**  
**Widening of Fanling Highway - Tai Hang to Wo Hop Shek Interchange**  
**3 Month Rolling Program(20-Aug-14)**



Date	Revision	C.	App...
22-Jan-14	IWP Rev 4		
26-Feb-14	IWP Rev 5		
13-May-...	WP Rev 1		
30-Jun-14	WP Rev...		

Activity ID	Activity Name	Duration % Complete	Remaining Duration	Original Duration	Start	Finish	Total Float	2014				
								Aug	Sep	Oct	Nov	
<b>NB59 (Ch.6490-6590)-TWSR West Side</b>												
<b>Noise Barrier Works</b>												
NB00940	NB59 -Pre-drilling	0%	47	47	05-May-14 A	16-Oct-14	-155					
NB00950	NB59 - piling (0.19m -94no)	0%	144	144	17-Oct-14	17-Apr-15	-155					
<b>NB63 (Ch.6610-6700)-TWSR West Side</b>												
<b>Noise Barrier Works</b>												
NB01020	NB63 - Footing & Wall Structure	0%	60	60	18-Nov-14	29-Jan-15	-135					
NB4560	NB63 - ID3-1 Footing & Wall Structure	88.33%	7	60	14-Jun-14 A	27-Aug-14	-8					
<b>DSD Southern Trunk Sewer, Water Main Fire Main Works</b>												
TSZ10300	Sheet Piling & Excavation (~7m below ground) (along NB63)	0%	22	12	23-Jul-14 A	15-Sep-14	-135					
TSZ10310	DSD Trunk Sewer laying (along NB63)	0%	18	18	16-Sep-14	08-Oct-14	-135					
TSZ10320	Backfill up to NB63 footing level	0%	34	34	09-Oct-14	17-Nov-14	-135					
TSZ10330	Watermain installation (along NB63)	0%	30	30	18-Nov-14	22-Dec-14	-135					
<b>DSD Southern Trunk Sewer - Trenchless Construction</b>												
TSZ10950	Construct Pipe jacking pits	0%	60	60	16-Sep-14	26-Nov-14	61					
<b>Box Culvert Extension ID1</b>												
<b>Structure Works</b>												
ID1-0100	Box Culvert Extension ID1 structure	0%	118	118	01-Nov-14	30-Mar-15	-118					
<b>Box Culvert Extension ID2</b>												
<b>Structure Works</b>												
ID2-0100	Box Culvert Extension ID2 structure	0%	118	118	01-Nov-14	30-Mar-15	-118					
<b>Bridge Construction</b>												
<b>New Tai Hang Footbridge</b>												
<b>General</b>												
THBF0330	Structure steel Shop drawing submission (THFB)	0%	60	60	20-Aug-14	31-Oct-14	621					
THBF0335	Structure steel Shop drawing approval (THFB)	0%	30	30	15-Oct-14	18-Nov-14	621					
THBF0340	Structure steel procurement (THFB)	0%	150	150	19-Nov-14	17-Apr-15	777					
<b>TWSR-West/ FL Highway N/B Side Section</b>												
THBF0120	THP5 - Pre-bored H pile (8 nos)	0%	24	24	03-Sep-14	03-Oct-14	-79					
THBF0130	THP5 - Pile Test	0%	28	28	04-Oct-14	31-Oct-14	1013					
THBF0140	THP5 - Pile cap, Pier and Pier Head	0%	45	45	18-Oct-14	09-Dec-14	808					
THBF0160	THP8, THP9 - Pre-bored H pile (8 nos)	0%	24	24	04-Oct-14	31-Oct-14	-79					
THBF0170	THP8, THP9 - Pile Test	0%	28	28	01-Nov-14	28-Nov-14	1111					
THBF0180	THP8, THP9 - Pile cap, Pier and Pier Head	0%	30	30	15-Nov-14	19-Dec-14	889					
THBF0200	THAB3 - Pre-bored H pile (4 nos)	0%	12	12	20-Aug-14	02-Sep-14	-79					
THBF0210	THAB3 - Pile Test	0%	28	28	03-Sep-14	30-Sep-14	1139					
THBF0220	THAB3 - pile cap & abutment wall	0%	30	30	17-Sep-14	23-Oct-14	911					
THBF0230	THAB3 - Backfilling (~4m)	0%	27	27	24-Oct-14	24-Nov-14	911					
THBF0290	THAB2 - Pre-bored H pile (18 nos)	0%	54	54	01-Nov-14	06-Jan-15	-79					
<b>TWSR-East FL Highway S/B Side Section</b>												
THBF0440	THAB1 - Predrilling	0%	12	12	20-Aug-14	02-Sep-14	746					
THBF0490	THP2 - Predrilling	0%	12	12	03-Sep-14	17-Sep-14	746					
THBF0700	THP3 - Predrilling	0%	6	6	18-Sep-14	24-Sep-14	764					
THBF0740	THP4 - Predrilling	0%	6	6	25-Sep-14	03-Oct-14	774					
<b>New Tai Wo Footbridge</b>												
<b>General</b>												
TWFB1010	Site Clearance	0%	30	30	25-Aug-14	29-Sep-14	-75					
TWFB1020	Structure steel Shop drawing submission (TWFB)	0%	90	90	20-Aug-14	05-Dec-14	842					
TWFB1030	Structure steel Shop drawing approval (TWFB)	0%	30	30	19-Nov-14	23-Dec-14	842					
<b>TWSR-West/ FL Highway N/B Side Section</b>												
TWFB1210	TWAB2 - Predrilling	0%	12	12	30-Sep-14	15-Oct-14	133					
TWFB1310	TWAB1 - Predrilling	0%	27	27	27-Jun-14 A	20-Sep-14	-68					
TWFB1320	TWAB1 - Pre-bored H pile (18 nos)	0%	54	54	30-Sep-14	03-Dec-14	-75					
<b>Temporary Tai Wo Footbridge</b>												
<b>Design Works</b>												
TWFB-T1010	Design preparation	0%	90	90	20-Aug-14	05-Dec-14	273					
<b>Demolition of Existing Tai Wo Footbridge</b>												
<b>TWSR-West/ FL Highway N/B Side Section</b>												
TWFB-DE0900	Site Clearance	0%	30	30	20-Aug-14	24-Sep-14	660					
<b>Noise Barrier Along Fanling Highway S/B</b>												
<b>NB51 (Ch.5935-6055)-FH S/B Side</b>												
<b>Noise Barrier Works</b>												
NB02270	NB51 ID1-3 (0-25m) - Sheet piling & Excavation	0%	21	21	20-Aug-14	13-Sep-14	408					
NB02280	NB51 ID1-3 (0-25m) - Footing & Wall Structure	0%	90	90	15-Sep-14	02-Jan-15	408					
<b>NB61A (Ch.6560-6745)-FH S/B Side (MTRC I&amp;P Area)</b>												
<b>Noise Barrier Works</b>												
NB03020	NB61A (75-190m) - Footing & Wall Structure	24.29%	53	70	02-Jun-14 A	23-Oct-14	-190					
NB03030	NB61A (75-190m)- backfilling	0%	80	80	24-Oct-14	28-Jan-15	-190					
NB03040	NB61A (75-190m) - NB production	0%	45	45	24-Oct-14	07-Dec-14	1435					
<b>Other Works</b>												
<b>Site Clearance &amp; Demolition of Existing Structure</b>												
<b>Contract Condition</b>												
Z2.P2N.1280	Re-provision of Man Ching Lung Tong	0%	183	150	21-Jul-14 A	08-Apr-15	-59					
<b>General</b>												
Z2.P2N.1000	Liaison with relevant villages houses's owner and related parties	0%	30	30	10-Oct-14	13-Nov-14	-277					



Activity ID	Activity Name	Duration % Complete	Remaining Duration	Original Duration	Start	Finish	Total Float	2014				
								Aug	Sep	Oct	Nov	
Z2.P2N.1010	Submission of contractor's design for site formation	0%	28	28	14-Nov-14	16-Dec-14	-277					
<b>South Buffer Zone 1 (SBZ1) (within Zone 2)(Ch.6740 to 6930)</b>												
<b>General</b>												
<b>General</b>												
<b>General</b>												
POSSA328a	Tree Felling/ Transplant (SA328)	0%	30	30	29-Aug-14	06-Oct-14	-110					
POSSA328a10	Site Clearance/ Trip Pit etc	0%	30	30	07-Oct-14	10-Nov-14	-110					
POSSA329a	Tree Felling/ Transplant (SA329)	26.67%	22	30	19-Jul-14 A	15-Sep-14	-77					
POSSA329a10	Site Clearance/ Trip Pit etc	0%	30	30	16-Sep-14	22-Oct-14	-77					
<b>Noise Barrier Along TWSR-West and Laying New Utilities</b>												
<b>NB64 &amp; NB64A (Ch.6860-6920)-TWSR West Side</b>												
<b>Noise Barrier Works</b>												
NB001000	NB64 & NB64A -Pre-drilling	37.14%	22	35	15-May-14 A	15-Sep-14	-228					
NB001010	NB64 & NB64A -piling (0.19m -78no)	0%	90	90	16-Sep-14	03-Jan-15	-228					
<b>Bridge Construction</b>												
<b>Kau Lung Hang Vehicular Bridge</b>												
<b>General</b>												
Z2.KLH.1070	Consent from Engineer	10.71%	25	28	28-Nov-13 A	18-Sep-14	-67					
<b>KLH Bridge - West Ramp</b>												
Z2.KLH.0900	West Abutment- Pre-drilling work	0%	20	20	11-Nov-14	03-Dec-14	-110					
<b>KLH Bridge - Ramp R1</b>												
Z2.KLH.1430	Ramp R1 - Pre-drilling work (R1P1-P3)	0%	27	27	15-May-14 A	20-Sep-14	49					
<b>KLH Bridge - Deck 3</b>												
Z2.KLH.1325	Construct Temp Road - For diversion of existing TWR east	0%	20	20	23-Oct-14	14-Nov-14	-77					
Z2.KLH.1330	VBP6 - Diversion of TWSR east to temporary diversion work	0%	1	1	15-Nov-14	15-Nov-14	-77					
Z2.KLH.1340	VBP6 - Pre-drilling work	0%	5	5	17-Nov-14	21-Nov-14	-77					
Z2.KLH.1800	East Abutment - Pile testing	0%	30	30	20-Aug-14	24-Sep-14	-44					
Z2.KLH.1810	East Abutment - Pile caps, abutment wall construction	0%	75	75	25-Sep-14	23-Dec-14	-44					
Z2.KLH.1840	VBP7- Pile testing	0%	30	30	20-Aug-14	24-Sep-14	121					
Z2.KLH.1880	VBP8 - Pile testing	0%	30	30	20-Aug-14	24-Sep-14	31					
<b>KLH Bridge - Deck 2</b>												
Z2.KLH.1190	Temp road diversion at TWSR-W for TTA for VBP5 works	0%	45	45	23-Oct-14	13-Dec-14	-50					
<b>KLH Bridge - Ramp R2</b>												
Z2.KLH.1510	Ramp R2 - Pre-drilling work	0%	28	28	06-Feb-14 A	20-Oct-14	114					
Z2.KLH.1520	Ramp R2 - Pre-bored H-pile piling works (18 Nos.)	0%	54	54	27-Jun-14 A	29-Nov-14	114					
Z2.KLH.1590	Land Possession for House 190B	0%	0	0		30-Sep-14	0					
30-Sep-14* ♦ Land Possession for House 190B												
<b>Demolition of Existing Nam Wa Po Footbridge</b>												
<b>General</b>												
Z2.NWP.0500	Site Clearance	0%	20	20	29-Aug-14	22-Sep-14	-200					
Z2.NWP.1000	Modification of Existing Planter for Pier of Temporary Footbridge	0%	25	25	23-Sep-14	23-Oct-14	-200					
Z2.NWP.1010	Removal of Existing Staircase Portion	0%	26	26	24-Oct-14	22-Nov-14	-200					
<b>North Buffer Zone 2 (NBZ2) (within Zone 4) (Ch. 7925 to 8100)</b>												
<b>Site Formation</b>												
<b>Site Formation Works</b>												
<b>Site Formation Work</b>												
Z4SF1070	Backfilling (~20000m3)	43.33%	102	180	10-May-14 A	19-Dec-14	-107					
<b>Retaining Wall W76</b>												
<b>Structure Works</b>												
RW761080	Base slab - W76 (~7m high)	0%	22	22	20-Aug-14	15-Sep-14	-97					
RW761085	Wall construction - W76 (~7m high)	0%	40	40	16-Sep-14	03-Nov-14	-97					
<b>Bridge Construction</b>												
<b>New Ho Ka Yuen Footbridge</b>												
<b>General</b>												
HKY1030	Structure steel Shop drawing submission (HKYB)	95%	3	60	20-Jun-14 A	22-Aug-14	-101					
HKY1040	Structure steel Shop drawing approval (HKYB)	0%	30	30	20-Aug-14	24-Sep-14	-113					
HKY1050	Structure steel procurement (HKYB)	0%	150	150	25-Sep-14	21-Feb-15	-135					
<b>TWSR-West/ FL Highway N/B Side Section</b>												
HKY1135	Soil nail works	0%	50	50	11-Sep-14	10-Nov-14	-112					
HKY1140	HKYP6 - Predrilling	0%	24	24	11-Nov-14	08-Dec-14	-112					
HKY1275	Existing HKY bridge structure removed (TWSR-W)	0%	0	0		18-Nov-14	-83					
HKY1320	HKYAB4 - Predrilling	0%	24	24	19-Nov-14	16-Dec-14	-83					
<b>TWSR-East FL Highway S/B Side Section</b>												
HKY1520	HKYAB1 - Pile Test	0%	28	28	20-Aug-14	16-Sep-14	23					
HKY1530	HKYAB1 - pile cap & abutment wall	0%	30	30	03-Sep-14	10-Oct-14	19					
HKY1540	HKYAB1 - Backfilling (~3m)	0%	20	20	11-Oct-14	03-Nov-14	19					
HKY1570	HKYP3 - Pile Test	0%	28	28	20-Aug-14	16-Sep-14	31					
HKY1580	HKYP3 - Pile cap, Pier and Pier Head	0%	45	45	03-Sep-14	28-Oct-14	24					
HKY1750	HKYP4 - Pile Test	0%	28	28	20-Aug-14	16-Sep-14	-2					
HKY1760	HKYP4 - Pile cap, Pier and Pier Head	0%	45	45	17-Sep-14	10-Nov-14	-2					
HKY1780	HKYP5 - Pre-bored H pile (8 nos)	87.5%	3	24	22-Jul-14 A	22-Aug-14	51					
HKY1790	HKYP5 - Pile Test	0%	28	28	23-Aug-14	19-Sep-14	63					
HKY1800	HKYP5 - Pile cap, Pier and Pier Head	0%	45	45	11-Nov-14	05-Jan-15	-2					
HKY1820	HKYAB2 - Pre-bored H pile (22 nos)	72.73%	18	66	10-Jun-14 A	10-Sep-14	-17					
HKY1830	HKYAB2 - Pile Test	0%	28	28	11-Sep-14	08-Oct-14	-21					

Activity ID	Activity Name	Duration % Complete	Remaining Duration	Original Duration	Start	Finish	Total Float	2014			
								Aug	Sep	Oct	Nov
HKY1840	HKYAB2 - pile cap & abutment wall	0%	60	60	09-Oct-14	17-Dec-14	-16				
<b>Demolition of Existing Ho Ka Yuen Footbridge</b>											
<b>TWSR-West/ FL Highway N/B Side Section</b>											
HKY1880	Construct Temp Ramp for existing HKY footbridge	80%	18	90	11-Jun-14 A	10-Sep-14	-112				
HKY1890	Pedestrian diversion	0%	1	1	11-Sep-14	11-Sep-14	-67				
HKY1900	Erect temp platform for demolishing Ramp & staircase at TWSR-W	0%	35	35	20-Aug-14	30-Sep-14	-83				
HKY1910	Demolish existing ramp & staircase at TWSR-W	0%	40	40	03-Oct-14	18-Nov-14	-83				
<b>ZONE 4 (Ch. 7925 to 8700)</b>											
<b>Bridge Construction</b>											
<b>New Wo Hop Shek Pedstrian &amp; Cycle Bridge</b>											
<b>General</b>											
WHS1020	Structure steel Shop drawing submission (WHSB)	91.43%	3	35	21-Jul-14 A	22-Aug-14	351				
WHS1030	Structure steel Shop drawing approval (WHSB)	0%	30	30	20-Aug-14	24-Sep-14	339				
WHS1040	Structure steel procurement (WHSB)	0%	150	150	25-Sep-14	21-Feb-15	421				
<b>TWSR-West/ FL Highway N/B Side Section</b>											
WHS1160	WHSP2 - Pre-bored H pile (8 nos)	0%	24	24	03-Sep-14	03-Oct-14	349				
WHS1170	WHSP2 - Pile Test	0%	28	28	04-Oct-14	31-Oct-14	431				
WHS1180	WHSP2 - Pile cap, Pier and Pier Head	0%	45	45	18-Oct-14	09-Dec-14	349				
WHS1200	WHSP6 - Pre-bored H pile (6 nos)	0%	18	18	04-Oct-14	24-Oct-14	380				
WHS1210	WHSP6 - Pile Test	0%	28	28	25-Oct-14	21-Nov-14	475				
WHS1224	WHSP7 - Pre-bored H pile (6 nos)	0%	18	18	25-Oct-14	14-Nov-14	403				
WHS1226	WHSP7 - Pile Test	0%	28	28	15-Nov-14	12-Dec-14	511				
WHS1240	WHSAB1 - Pre-bored H pile (4 nos)	0%	12	12	20-Aug-14	02-Sep-14	349				
WHS1250	WHSAB1 - Pile Test	0%	28	28	03-Sep-14	30-Sep-14	1039				
WHS1260	WHSAB1 - pile cap & abutment wall	0%	30	30	17-Sep-14	23-Oct-14	829				
WHS1270	WHSAB1 - Backfilling (~4m)	0%	27	27	24-Oct-14	24-Nov-14	829				
WHS1894	WHSP3 - Pre-bored H pile (6 nos)	0%	18	18	20-Aug-14	10-Sep-14	408				
WHS1896	WHSP3 - Pile Test	0%	28	28	11-Sep-14	08-Oct-14	505				
WHS1898	WHSP3 - Pile cap, Pier and Pier Head	0%	30	30	09-Oct-14	12-Nov-14	402				
WHS1910	WHSP4 - Pre-bored H pile (6 nos)	0%	18	18	11-Sep-14	03-Oct-14	428				
WHS1920	WHSP4 - Pile Test	0%	28	28	04-Oct-14	31-Oct-14	536				
WHS1930	WHSP4 - Pile cap, Pier and Pier Head	0%	30	30	13-Nov-14	17-Dec-14	402				
WHS1950	WHSP5 - Pre-bored H pile (6 nos)	0%	18	18	04-Oct-14	24-Oct-14	437				
WHS1960	WHSP5 - Pile Test	0%	28	28	25-Oct-14	21-Nov-14	551				
<b>Crossing Fanling Highway Section</b>											
WHS1470	WHSP1 - Pile cap, Pier and Pier Head	0%	60	52	18-Jun-14 A	31-Oct-14	759				
<b>TWSR-East FL Highway S/B Side Section</b>											
WHS2060	North Abutment Wall (AW1) - Pre-bored H pile (4 nos)	0%	22	22	20-Aug-14	15-Sep-14	317				
WHS2070	North Abutment Wall (AW1) - Pile Test	0%	28	28	16-Sep-14	13-Oct-14	763				
WHS2075	North Abutment Wall (AW1) - Temp Shoring	0%	45	45	16-Sep-14	08-Nov-14	317				
WHS2080	North Abutment Wall (AW1) - pile cap & abutment wall	0%	60	60	10-Nov-14	21-Jan-15	577				
<b>Slip Road Y Construction</b>											
<b>Underground Utility Works</b>											
<b>DN600 and DN900 Watermain</b>											
DN1000	DN600 & DN900 watermain laying (Ch8250-8370)(SA340) (near Z4	15.71%	59	70	19-Aug-14 A	30-Oct-14	-414				
<b>VO - Wall 76A Construction</b>											
<b>Retaining Wall W76A</b>											
<b>TWSR-East FL Highway S/B Side Section</b>											
W76A1018	Temp. road work for TTA for W76A	0%	26	26	31-Oct-14	29-Nov-14	-414				
W76A1032	W76A construction (bay 1-2 & 11-13)	96%	3	75	19-May-14 A	22-Aug-14	-212				
W76A1035	W76A backfilling work (bay 1-2 & 11-13)	0%	26	26	23-Aug-14	23-Sep-14	-212				
<b>Other Works</b>											
<b>Retaining Wall W77A</b>											
<b>TWSR-East FL Highway S/B Side Section</b>											
RWZ4.1060	Base slab & Wall (0-3m high)- RW77A (Ch.50-130)	0%	60	60	20-Aug-14	31-Oct-14	369				
RWZ4.1070	Backfilling (0-3m) - RW77A (Ch.50-130)	0%	30	30	01-Nov-14	05-Dec-14	624				
RWZ4.1075	Temp Shoring & Excavation	0%	45	45	10-Nov-14	03-Jan-15	317				
<b>Retaining Wall W77B</b>											
<b>TWSR-East FL Highway S/B Side Section</b>											
RWZ4.1092	Site Clearance	86.67%	4	30	21-Jul-14 A	23-Aug-14	500				
RWZ4.1100	Base slab & Wall (0-3m high)- RW77B (Ch 0-40)	0%	60	60	01-Nov-14	13-Jan-15	444				
<b>Retaining Wall W78</b>											
<b>TWSR-East FL Highway S/B Side Section</b>											
RWZ4.0900	Site Clearance	0%	30	30	25-Aug-14	29-Sep-14	530				
<b>TCSS Works</b>											
<b>TCSS Pre-Construction Works</b>											
TCSS0100	Acquire Design Criteria from Drawing & procurement	0%	180	180	20-Aug-14	01-Apr-15	435				

---

---

**APPENDIX C  
IMPLEMENTATION SCHEDULE OF  
ENVIRONMENTAL MITIGATION MEASURES  
(EMIS)**

---

---

## **Appendix C - Implementation Schedule of Environmental Mitigation Measures (EMIS)**

### **Air Quality – Schedule of Recommended Mitigation Measures**

<b>Impact</b>	<b>Mitigation Measures</b>	<b>Timing</b>	<b>Implementation Status</b>
Air Quality during construction	Restricting heights from which materials are dropped, as far as practicable to minimize the fugitive dust arising from unloading/loading.	During construction	V
	All stockpiles of excavated materials or spoil of more than 50m <sup>3</sup> shall be enclosed, covered or dampened during dry or windy conditions.		V
	Effective water sprays shall be used to control potential dust emission sources such as unpaved haul roads and active construction areas.		V
	All spraying of materials and surfaces shall avoid excessive water usage.		V
	Vehicles that have the potential to create dust while transporting materials shall be covered, with the cover properly secured and extended over the edges of the side and tail boards.		V
	Materials shall be dampened, if necessary, before transportation.		V
	Travelling speeds shall be controlled to reduce traffic induced dust dispersion and re-suspension within the site from the operating haul trucks.		V
	Vehicle washing facilities shall be provided to minimize the quantity of material deposited on public roads.		V

### Noise – Schedule of Recommended Mitigation Measures

Impact	Mitigation Measures	Timing	Implementation Status
Noise during construction	Use of silenced plant or plant equipped with mufflers or dampers in substitute of ordinary plant.	During construction	@
	Reduce the number of equipment and their percentage on-time.		V
	3.5 m and 5.5 m high temporary noise barrier at culvert construction work area (Figure 2a of the Environmental Permit).		#
	3 m high temporary noise barrier along the northern edge of Bridge 12 at ground level (Figure 2b of the Environmental Permit).		#
	2 m high temporary noise barrier along the northern edge of Bridge 12 at bridge level (Figure 2b of the Environmental Permit).		#
	2.5 m high temporary noise barrier along Tai Wo Service Road West (Figure 2c of the Environmental Permit).		#
	3.5m and 7m high temporary noise barrier along Tai Wo Services Road West near Tai Hang (Figure 2c of the Environmental Permit).		#
	7 m high temporary noise barrier along Tai Wo Service Road West near Tai Wo Footbridge work area (Figure 2d of the Environmental Permit).		#
	7 m high temporary noise barrier near Kiu Tau Footbridge work area (Figure 2d of the Environmental Permit).		#
	2.5 m high temporary noise barrier near river diversion work area (Figure 2e of the Environmental Permit).		#

### Water Quality – Schedule of Recommended Mitigation Measures

Impact	Mitigation Measures	Timing	Implementation Status
Water quality during construction	Demolition and reconstruction of bridges <ul style="list-style-type: none"> <li>- Prevent off-site migration through use of sheet piles.</li> <li>- Minimise duration of works as far as practical.</li> <li>- All sewer and drainage connections should be sealed to prevent debris, soil, sand, etc, from entering public sewers/drains.</li> <li>- Site surface runoff should be settled to remove sand/silt before it is discharged into the existing storm drains.</li> </ul>	During construction	#
	Road Widening Works, Earthworks and Culvert Extension Works <ul style="list-style-type: none"> <li>- Wastewater generated from any concrete batching washdown of equipment or similar activities should be discharged into foul sewers, after the removal of settleable solids, and pH adjustment as necessary. All sewage discharges from the study area should meet the TM standards and approval from EPD through the licensing process is required.</li> <li>- Sand traps, oil interceptors and other pollution prevention installations should be provided, properly cleaned and maintained.</li> <li>- Runoff from exposed working areas, unfinished slopes and from unlined temporary channels should be directed to stilling basins and/or silt traps before discharging to the drainage outfalls.</li> <li>- Regular inspections of stilling basins and/or silt traps is required to ensure that sediment is not conveyed into the existing drainage system.</li> <li>- Open stockpiles should be covered with a tarpaulin cover.</li> <li>- During the wet season, any exposed top soils should be covered with a tarpaulin, shotcreted or hydroseeded.</li> <li>- Sand and silt from wash-water from vehicle washing should be settled out before discharging into storm drains.</li> <li>- Fuels should be stored in bunded areas such that spillage can be easily collected.</li> </ul>		V

### Waste – Schedule of Recommended Mitigation Measures

Impact	Mitigation Measures	Timing	Implementation Status
Waste management during construction	<b>General Waste</b> <ul style="list-style-type: none"> <li>- Transport of wastes off site as soon as possible.</li> <li>- Maintenance of accurate waste records.</li> <li>- Minimisation of waste generation for disposal (via reduction/recycling/re-use).</li> <li>- No on-site burning will be permitted.</li> <li>- Use of re-useable metal hoardings/signboards.</li> </ul>	During construction	V
	<b>Vegetation from site clearance</b> <ul style="list-style-type: none"> <li>- Segregation of materials to facilitate disposal.</li> <li>- Mulching to reduce bulk and where possible review opportunities for the possible beneficial use within landscaping areas.</li> </ul>		V
	<b>Demolition Wastes</b> <ul style="list-style-type: none"> <li>- Segregation of materials to facilitate disposal.</li> <li>- Appropriate stockpile management.</li> </ul>		V
	<b>Excavated Materials</b> <ul style="list-style-type: none"> <li>- Segregation of materials to facilitate disposal / reuse.</li> <li>- Appropriate stockpile management.</li> <li>- Re-use of excavated material on or off site (where possible).</li> <li>- Special handling and disposal procedures in the event that contaminated materials are excavated.</li> </ul>		V
	<b>Construction Wastes</b> <ul style="list-style-type: none"> <li>- Segregation of materials to facilitate recycling/reuse (within designated area in appropriate containers/stockpiles).</li> <li>- Appropriate stockpile management.</li> <li>- Planning to reduce over ordering and waste generation.</li> <li>- Recycling and re-use of materials where possible (e.g. metal, wood from formwork)</li> <li>- For material which cannot be re-used/recycled, collection should be carried out by an approved waste contractor for landfill disposal.</li> </ul>		V
	<b>Bentonite Slurries</b> <ul style="list-style-type: none"> <li>- Bentonite slurries should be reused as far as possible.</li> <li>- Disposal in accordance with Practice Note For Professional Persons ProPECC PN 1/94.</li> </ul>		#

	<p>Chemical Wastes</p> <ul style="list-style-type: none"> <li>- Storage within locked, covered and bunded area.</li> <li>- The storage area shall not be located adjacent to sensitive receivers e.g. drains.</li> <li>- Minimise waste production and recycle oils/solvents where possible.</li> <li>- A spill response procedure shall be in place and absorption material available for minor spillages.</li> <li>- Use appropriate and labelled containers.</li> <li>- Educate site workers on site cleanliness/waste management procedures.</li> <li>- If chemical wastes are to be generated, the contractor must register with EPD as a chemical waste producer.</li> <li>- The chemical wastes shall be collected by a licensed chemical waste collector.</li> </ul>		+
	<p>Municipal Wastes</p> <ul style="list-style-type: none"> <li>- Waste shall be stored within a temporary refuse collection facility, in appropriate containers prior to collection and disposal.</li> <li>- Regular, daily collections are required by an approved waste collector.</li> </ul>		V



### Ecology – Schedule of Recommended Mitigation Measures

Impact	Mitigation Measures	Timing	Implementation Status
Ecology during construction	<p>Accurate Delineation of Works Area</p> <ul style="list-style-type: none"> <li>- Boundaries of proposed works areas shall be clearly identified and separated from external areas by a physical barrier to prevent encroachment of adjacent habitats.</li> <li>- Individual trees which fall within the works areas but which work plans do not require removal are to be retained and fenced off to maximize protection.</li> </ul>	During construction	V
	<p>Vegetation Clearance</p> <ul style="list-style-type: none"> <li>- No fires shall be lit within the works area for the purpose of burning cleared vegetation.</li> <li>- The Contractor shall give consideration to mulching the cleared vegetation for recycling within the works area / adjacent land.</li> </ul>		V
	<p>Dust generation</p> <p>There are a number of measures which shall be taken as specified in the Air Pollution Control (Construction Dust) Regulation on 'Dust Control Requirements, including the following key measures to be applied during construction:</p> <ul style="list-style-type: none"> <li>- Vehicle washing facilities to be provided at every discernible or designated vehicle exit point;</li> <li>- All temporary site access roads shall be sprayed with water to suppress dust as necessary;</li> <li>- All dusty materials should be sprayed with water immediately prior to any handling; and</li> <li>- All debris should be covered entirely by impervious sheeting or stored in a sheltered debris collection area.</li> </ul>		V
	<p>Surface Run-off</p> <p>In general, mitigation measures shall be in accordance with ProPECC PN1/94 on 'Construction Site Drainage'. Key measures include:</p> <ul style="list-style-type: none"> <li>- Bund and cover stock piles to avoid run-off;</li> <li>- Channel any run-off through a system of oil, grease and sediment / silt traps and reuse water on site where ever practical;</li> <li>- All vehicle maintenance to be undertaken within a bunded area; and</li> <li>- Maximise vegetation retention on-site to maximise absorption (minimise transport).</li> </ul>		V

### Landscape and Visual Impact – Schedule of Recommended Mitigation Measures

Impact	Mitigation Measures	Timing	Responsibility
Landscape & Visual during construction	Preservation of Existing Vegetation - Trees identified for retention within the project limit would be protected during the works; - The tree transplanting and planting works shall be implemented by approved Landscape Contractors.	During construction	V
	Temporary Works Areas - Where feasible the works areas would be screened using hoarding and existing vegetation would be retained where possible to reduce the landscape and visual impacts arising from the construction activity. The landscape of these works areas would be restored following the completion of the construction phase.		V
	Hoarding - A hoarding would be erected where practicable in the most visually sensitive locations to screen the temporary construction works from the local VSRs.		V
	Top Soils - The works will result in disturbance to extensive areas of topsoil. Topsoil worthy of retention should be stockpiled for use following completion of the civil engineering works. It should either be temporarily vegetated with hydroseeded grass or turned over on a regular basis.		#
	Protection of Important Landscape Features - Important features such as temples, Island House and kilns within the study area, although remote from the proposed works retained and adequately protected.		#

Legend:

- V = implemented;
- x = not implemented;
- @ = partially implemented;
- + = recommended and immediately implemented during the site inspection by the Contractor;
- N/A = not applicable - No such work was undertaken or no such material was used on site;
- # = to be implemented.

---

---

**APPENDIX D  
SUMMARY OF ACTION AND LIMIT LEVELS**

---

---

## Appendix D - Summary of Action and Limit Levels

Table 1 – Action and Limit Levels for 1-hour TSP

Location	Action Level	Limit Level
AM2	317.8 µg/m <sup>3</sup>	500 µg/m <sup>3</sup>

Table 2 – Action and Limit Levels for 24-hour TSP

Location	Action Level	Limit Level
AM2	200.7 µg/m <sup>3</sup>	260 µg/m <sup>3</sup>

Table 3 – Action and Limit Levels for Construction Noise (0700-1900 hrs of normal weekdays)

Location	Action Level	Limit Level
M2	When one documented complaint, related to 0700 – 1900 hours on normal weekdays, is received from any one of the sensitive receivers	75 dB(A)
M3*		65/70 dB(A)

\*Daytime noise Limit Level of 70 dB(A) applies to education institutions, while 65dB(A) applies during school examination period

---

---

**APPENDIX E  
CALIBRATION CERTIFICATES OF  
MONITORING EQUIPMENTS**

---

---

**Total Suspended Particulates (TSP) Sampler**  
**Field Calibration Report**

Station Fanling Government Secondary School (AM2)  
 Date: 6-Jun-14  
 Model No: TE-5170  
 Equipment No.: A-001-74T

Operator: Shum Kam Yuen  
 Next Due Date: 6-Aug-14  
 Verified Against: O.T.S -- 988  
 Expiration Date: 28-May-2015

Ambient Condition			
Temperature, Ta	301.0	Kelvin	Pressure, Pa
			753.8 mmHg

Orifice Transfer Standard Information					
Equipment No.:	988	Slope, mc	1.97518	Intercept, bc	-0.01001
Last Calibration Date:	28-May-14	$mc \times Qstd + bc = [H \times (Pa/760) \times (298/Ta)]^{1/2}$			
Next Calibration Date:	28-May-15				

Calibration of TSP Sampler					
Calibration Point	H in. of water	[H x (Pa/760) x (298/Ta)] <sup>1/2</sup>	Qstd (m <sup>3</sup> /min) <b>X - axis</b>	W in. of oil	[ΔW x (Pa/760) x (298/Ta)] <sup>1/2</sup> <b>Y-axis</b>
1	6.1	2.45	1.24	4.6	2.13
2	5.0	2.22	1.13	4.0	1.98
3	4.5	2.10	1.07	3.3	1.80
4	3.7	1.91	0.97	2.7	1.63
5	2.3	1.50	0.77	1.5	1.21

**By Linear Regression of Y on X**  
 Slope, mw = 1.9918                                      Intercept, bw = -0.3135  
 Correlation Coefficient\* = 0.9970

**Set Point Calculation**

From the TSP Field Calibration Curve, take Qstd = 1.21 m<sup>3</sup>/min (43 CFM)  
 From the Regression Equation, the "Y" value according to

$m \times Qstd + b = [W \times (Pa/760) \times (298/Ta)]^{1/2}$

Therefore, Set Point W =  $(m \times Qstd + b)^2 \times (760 / Pa) \times (Ta / 298) =$  4.48

\*If Correlation Coefficient < 0.990, check and recalibrate again.

Remarks: \_\_\_\_\_

QC Reviewer: WS CHAN                                      Signature: [Signature]                                      Date: 6/6/14

**Total Suspended Particulates (TSP) Sampler  
Field Calibration Report**

Station Fanling Government Secondary School (AM2)  
 Date: 5-Aug-14  
 Model No: TE-5170  
 Equipment No.: A-001-74T

Operator: Shum Kam Yuen  
 Next Due Date: 5-Oct-14  
 Verified Against: O.T.S -- 988  
 Expiration Date: 28-May-2015

Ambient Condition			
Temperature, Ta	303.0	Kelvin	Pressure, Pa
			752.2 mmHg

Orifice Transfer Standard Information					
Equipment No.:	988	Slope, mc	1.97518	Intercept, bc	-0.01001
Last Calibration Date:	28-May-14	$mc \times Qstd + bc = [H \times (Pa/760) \times (298/Ta)]^{1/2}$			
Next Calibration Date:	28-May-15				

Calibration of TSP Sampler					
Calibration Point	H in. of water	$[H \times (Pa/760) \times (298/Ta)]^{1/2}$	Qstd (m <sup>3</sup> /min) X - axis	W in. of oil	$[\Delta W \times (Pa/760) \times (298/Ta)]^{1/2}$ Y-axis
1	6.1	2.44	1.24	4.6	2.12
2	5.0	2.21	1.12	3.9	1.95
3	4.4	2.07	1.05	3.4	1.82
4	3.5	1.85	0.94	2.6	1.59
5	2.1	1.43	0.73	1.5	1.21

**By Linear Regression of Y on X**  
 Slope , mw = 1.8211      Intercept, bw = -0.1123  
 Correlation Coefficient\* = 0.9983

**Set Point Calculation**

From the TSP Field Calibration Curve, take Qstd = 1.21 m<sup>3</sup>/min (43 CFM)  
 From the Regression Equation, the "Y" value according to

$$m \times Qstd + b = [W \times (Pa/760) \times (298/Ta)]^{1/2}$$

Therefore, Set Point W = ( m x Qstd + b )<sup>2</sup> x ( 760 / Pa ) x ( Ta / 298 ) = 4.49

\*If Correlation Coefficient < 0.990, check and recalibrate again.

Remarks: \_\_\_\_\_

QC Reviewer: N/S CHAN      Signature: [Signature]      Date: 6/18/14



TISCH ENVIRONMENTAL, INC.  
 145 SOUTH MIAMI AVE  
 VILLAGE OF CLEVELAND, OH  
 45002  
 513.467.9000  
 877.263.7610 TOLL FREE  
 513.467.9009 FAX

ORIFICE TRANSFER STANDARD CERTIFICATION WORKSHEET TE-5025A

Date - May 28, 2014 Rootsmeter S/N 0438320 Ta (K) - 296  
 Operator Tisch Orifice I.D. - 0988 Pa (mm) - 751.84

PLATE OR Run #	VOLUME START (m3)	VOLUME STOP (m3)	DIFF VOLUME (m3)	DIFF TIME (min)	METER DIFF Hg (mm)	ORFICE DIFF H2O (in.)
1	NA	NA	1.00	1.3790	3.2	2.00
2	NA	NA	1.00	0.9720	6.4	4.00
3	NA	NA	1.00	0.8690	7.9	5.00
4	NA	NA	1.00	0.8260	8.8	5.50
5	NA	NA	1.00	0.6830	12.8	8.00

DATA TABULATION

Vstd	(x axis) Qstd	(y axis)	Va	(x axis) Qa	(y axis)
0.9917	0.7191	1.4113	0.9957	0.7221	0.8874
0.9875	1.0159	1.9959	0.9915	1.0201	1.2549
0.9854	1.1339	2.2315	0.9894	1.1385	1.4030
0.9843	1.1916	2.3405	0.9883	1.1965	1.4715
0.9790	1.4333	2.8227	0.9829	1.4392	1.7747
Qstd slope (m) = 1.97518			Qa slope (m) = 1.23683		
intercept (b) = -0.01001			intercept (b) = -0.00630		
coefficient (r) = 0.99998			coefficient (r) = 0.99998		
y axis = $\text{SQRT}[\text{H2O}(\text{Pa}/760)(298/\text{Ta})]$			y axis = $\text{SQRT}[\text{H2O}(\text{Ta}/\text{Pa})]$		

CALCULATIONS

$$\text{Vstd} = \text{Diff. Vol} [(\text{Pa} - \text{Diff. Hg}) / 760] (298 / \text{Ta})$$

$$\text{Qstd} = \text{Vstd} / \text{Time}$$

$$\text{Va} = \text{Diff Vol} [(\text{Pa} - \text{Diff Hg}) / \text{Pa}]$$

$$\text{Qa} = \text{Va} / \text{Time}$$

For subsequent flow rate calculations:

$$\text{Qstd} = 1/m \{ [\text{SQRT}(\text{H2O}(\text{Pa}/760)(298/\text{Ta}))] - b \}$$

$$\text{Qa} = 1/m \{ [\text{SQRT} \text{H2O}(\text{Ta}/\text{Pa})] - b \}$$



## EQUIPMENT CALIBRATION RECORD

Type: Laser Dust Monitor  
 Manufacturer/Brand: SIBATA  
 Model No.: LD-3  
 Equipment No.: A.005.07a  
 Sensitivity Adjustment Scale Setting: 557 CPM

Operator: Mike Shek (MSKM)

### Standard Equipment

Equipment: Rupprecht & Patashnick TEOM®  
 Venue: Cyberport (Pui Ying Secondary School)  
 Model No.: Series 1400AB  
 Serial No: Control: 140AB219899803  
 Sensor: 1200C143659803 K<sub>0</sub>: 12500  
 Last Calibration Date\*: 10 May 2014

\*Remarks: Recommended interval for hardware calibration is 1 year

### Calibration Result

Sensitivity Adjustment Scale Setting (Before Calibration): 557 CPM  
 Sensitivity Adjustment Scale Setting (After Calibration): 557 CPM

Hour	Date (dd-mm-yy)	Time	Ambient Condition		Concentration <sup>1</sup> (mg/m <sup>3</sup> ) Y-axis	Total Count <sup>2</sup>	Count/ Minute <sup>3</sup> X-axis
			Temp (°C)	R.H. (%)			
1	11-05-14	09:30 - 10:30	26.7	75	0.04434	1775	29.58
2	11-05-14	10:30 - 11:30	26.7	75	0.04716	1880	31.33
3	11-05-14	11:30 - 12:30	26.8	76	0.04927	1964	32.73
4	11-05-14	12:30 - 13:30	26.8	75	0.05035	2015	33.58

Note: 1. Monitoring data was measured by Rupprecht & Patashnick TEOM®  
 2. Total Count was logged by Laser Dust Monitor  
 3. Count/minute was calculated by (Total Count/60)

By Linear Regression of Y or X

Slope (K-factor): 0.0015  
 Correlation coefficient: 0.9982

Validity of Calibration Record: 11 May 2015

Remarks:

QC Reviewer: YW Fung

Signature: 

Date: 12 May 2014

## EQUIPMENT CALIBRATION RECORD

Type: Laser Dust Monitor  
 Manufacturer/Brand: SIBATA  
 Model No.: LD-3  
 Equipment No.: A.005.09a  
 Sensitivity Adjustment Scale Setting: 797 CPM  
 Operator: Mike Shek (MSKM)

### Standard Equipment

Equipment: Rupprecht & Patashnick TEOM®  
 Venue: Cyberport (Pui Ying Secondary School)  
 Model No.: Series 1400AB  
 Serial No: Control: 140AB219899803  
 Sensor: 1200C143659803 K<sub>0</sub>: 12500  
 Last Calibration Date\*: 10 May 2014

\*Remarks: Recommended interval for hardware calibration is 1 year

### Calibration Result

Sensitivity Adjustment Scale Setting (Before Calibration): 797 CPM  
 Sensitivity Adjustment Scale Setting (After Calibration): 797 CPM

Hour	Date (dd-mm-yy)	Time	Ambient Condition		Concentration <sup>1</sup> (mg/m <sup>3</sup> ) Y-axis	Total Count <sup>2</sup>	Count/ Minute <sup>3</sup> X-axis
			Temp (°C)	R.H. (%)			
1	11-05-14	13:30 - 14:30	26.8	75	0.05034	2017	33.62
2	11-05-14	14:30 - 15:30	26.9	76	0.05211	2084	34.73
3	11-05-14	15:30 - 16:30	26.9	76	0.05163	2066	34.43
4	11-05-14	16:30 - 17:30	26.9	76	0.05272	2113	35.22

Note: 1. Monitoring data was measured by Rupprecht & Patashnick TEOM®  
 2. Total Count was logged by Laser Dust Monitor  
 3. Count/minute was calculated by (Total Count/60)

By Linear Regression of Y or X

Slope (K-factor): 0.0015  
 Correlation coefficient: 0.9965

Validity of Calibration Record: 11 May 2015

Remarks:

QC Reviewer: YW Fung Signature:  Date: 12 May 2014

## EQUIPMENT CALIBRATION RECORD

Type: Laser Dust Monitor  
 Manufacturer/Brand: SIBATA  
 Model No.: LD-3B  
 Equipment No.: A.005.14a  
 Sensitivity Adjustment Scale Setting: 786 CPM

Operator: Mike Shek (MSKM)

### Standard Equipment

Equipment: Rupprecht & Patashnick TEOM®  
 Venue: Cyberport (Pui Ying Secondary School)  
 Model No.: Series 1400AB  
 Serial No: Control: 140AB219899803  
 Sensor: 1200C143659803 K<sub>0</sub>: 12500  
 Last Calibration Date\*: 10 May 2014

\*Remarks: Recommended interval for hardware calibration is 1 year

### Calibration Result

Sensitivity Adjustment Scale Setting (Before Calibration): 786 CPM  
 Sensitivity Adjustment Scale Setting (After Calibration): 786 CPM

Hour	Date (dd-mm-yy)	Time	Ambient Condition		Concentration <sup>1</sup> (mg/m <sup>3</sup> ) Y-axis	Total Count <sup>2</sup>	Count/ Minute <sup>3</sup> X-axis
			Temp (°C)	R.H. (%)			
1	18-05-14	12:45 - 13:45	28.4	77	0.05027	2158	35.97
2	18-05-14	13:45 - 14:45	28.5	76	0.05161	2211	36.85
3	18-05-14	14:45 - 15:45	28.5	76	0.05235	2247	37.45
4	18-05-14	15:45 - 16:45	28.4	77	0.05203	2233	37.22

Note: 1. Monitoring data was measured by Rupprecht & Patashnick TEOM®  
 2. Total Count was logged by Laser Dust Monitor  
 3. Count/minute was calculated by (Total Count/60)

By Linear Regression of Y or X

Slope (K-factor): 0.0014  
 Correlation coefficient: 0.9969

Validity of Calibration Record: 18 May 2015

Remarks:

QC Reviewer: YW Fung Signature:  Date: 19 May 2014

## EQUIPMENT CALIBRATION RECORD

Type: Laser Dust Monitor  
 Manufacturer/Brand: SIBATA  
 Model No.: LD-3B  
 Equipment No.: A.005.16a  
 Sensitivity Adjustment Scale Setting: 521 CPM

Operator: Mike Shek (MSKM)

### Standard Equipment

Equipment: Rupprecht & Patashnick TEOM®  
 Venue: Cyberport (Pui Ying Secondary School)  
 Model No.: Series 1400AB  
 Serial No: Control: 140AB219899803  
 Sensor: 1200C143659803 K<sub>o</sub>: 12500  
 Last Calibration Date\*: 18 May 2013

\*Remarks: Recommended interval for hardware calibration is 1 year

### Calibration Result

Sensitivity Adjustment Scale Setting (Before Calibration): 521 CPM  
 Sensitivity Adjustment Scale Setting (After Calibration): 521 CPM

Hour	Date (dd-mm-yy)	Time	Ambient Condition		Concentration <sup>1</sup> (mg/m <sup>3</sup> ) Y-axis	Total Count <sup>2</sup>	Count/ Minute <sup>3</sup> X-axis
			Temp (°C)	R.H. (%)			
1	27-07-13	11:00 - 12:00	27.3	75	0.04734	1893	31.55
2	27-07-13	12:00 - 13:00	27.3	75	0.04789	1915	31.92
3	27-07-13	13:00 - 14:00	27.4	74	0.04953	1976	32.93
4	27-07-13	14:00 - 15:00	27.4	75	0.04867	1949	32.48

Note: 1. Monitoring data was measured by Rupprecht & Patashnick TEOM®  
 2. Total Count was logged by Laser Dust Monitor  
 3. Count/minute was calculated by (Total Count/60)

By Linear Regression of Y or X

Slope (K-factor): 0.0015  
 Correlation coefficient: 0.9934

Validity of Calibration Record: 26 July 2014

Remarks:

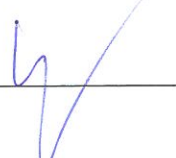
QC Reviewer: YW Fung Signature:  Date: 29 July 2013



## CERTIFICATE OF CALIBRATION

Certificate No.: 13CA1107 01-01 Page 1 of 2

### Item tested

Description:	Sound Level Meter (Type 1)	,	Microphone
Manufacturer:	Rion Co., Ltd.	,	Rion Co., Ltd.
Type/Model No.:	NL-31	,	UC-53A
Serial/Equipment No.:	00320528 / N.007.03A	,	90565
Adaptors used:	-	,	-

### Item submitted by

Customer Name: AECOM ASIA CO., LTD.  
Address of Customer: -  
Request No.: -  
Date of receipt: 07-Nov-2013

Date of test: 08-Nov-2013

### Reference equipment used in the calibration

Description:	Model:	Serial No.	Expiry Date:	Traceable to:
Multi function sound calibrator	B&K 4226	2288444	22-Jun-2014	CIGISMEC
Signal generator	DS 360	33873	15-Apr-2014	CEPREI
Signal generator	DS 360	61227	15-Apr-2014	CEPREI

### Ambient conditions

Temperature: 22 ± 1 °C  
Relative humidity: 60 ± 10 %  
Air pressure: 1000 ± 10 hPa

### Test specifications

- 1, The Sound Level Meter has been calibrated in accordance with the requirements as specified in BS 7580: Part 1: 1997 and the lab calibration procedure SMTP004-CA-152.
- 2, The electrical tests were performed using an electrical signal substituted for the microphone which was removed and replaced by an equivalent capacitance within a tolerance of ±20%.
- 3, The acoustic calibration was performed using an B&K 4226 sound calibrator and corrections was applied for the difference between the free-field and pressure response of the Sound Level Meter.

### Test results

This is to certify that the Sound Level Meter conforms to BS 7580: Part 1: 1997 for the conditions under which the test was performed.

Details of the performed measurements are presented on page 2 of this certificate.

Actual Measurement data are documented on worksheets.

Approved Signatory:

Huang Jian Min/Feng Jun Qi

Date: 11-Nov-2013

Company Chop:



Comments: The results reported in this certificate refer to the condition of the instrument on the date of calibration and carry no implication regarding the long-term stability of the instrument.



## CERTIFICATE OF CALIBRATION

Certificate No.: 14CA0305 06-01

Page 1 of 2

### Item tested

Description:	Sound Level Meter (Type 1)	,	Microphone
Manufacturer:	B & K	,	B & K
Type/Model No.:	2238	,	4188
Serial/Equipment No.:	2285692	, N.009.04	2250420
Adaptors used:	-	,	-

### Item submitted by

Customer Name: AECOM ASIA CO. LTD.  
Address of Customer: -  
Request No.: -  
Date of receipt: 05-Mar-2014

Date of test: 07-Mar-2014

### Reference equipment used in the calibration

Description:	Model:	Serial No.	Expiry Date:	Traceable to:
Multi function sound calibrator	B&K 4226	2288444	22-Jun-2014	CIGISMEC
Signal generator	DS 360	33873	15-Apr-2014	CEPREI
Signal generator	DS 360	61227	15-Apr-2014	CEPREI

### Ambient conditions

Temperature: 22 ± 1 °C  
Relative humidity: 60 ± 10 %  
Air pressure: 1000 ± 10 hPa

### Test specifications

- The Sound Level Meter has been calibrated in accordance with the requirements as specified in BS 7580: Part 1: 1997 and the lab calibration procedure SMTP004-CA-152.
- The electrical tests were performed using an electrical signal substituted for the microphone which was removed and replaced by an equivalent capacitance within a tolerance of ±20%.
- The acoustic calibration was performed using an B&K 4226 sound calibrator and corrections was applied for the difference between the free-field and pressure responsess of the Sound Level Meter.

### Test results

This is to certify that the Sound Level Meter conforms to BS 7580: Part 1: 1997 for the conditions under which the test was performed.

Details of the performed measurements are presented on page 2 of this certificate.

Actual Measurement data are documented on worksheets.

Approved Signatory:

  
Huang Jian Min/Feng Jun Qi

Date: 12-Mar-2014

Company Chop:



Comments: The results reported in this certificate refer to the condition of the instrument on the date of calibration and carry no implication regarding the long-term stability of the instrument.



## CERTIFICATE OF CALIBRATION

Certificate No.: 14CA0305 06-02 Page 1 of 2

### Item tested

Description:	Sound Level Meter (Type 1)	Microphone
Manufacturer:	B & K	B & K
Type/Model No.:	2250	4950
Serial/Equipment No.:	2681366 N.011.01	2665582
Adaptors used:	-	-

### Item submitted by

Customer Name: AECOM ASIA CO. LTD.  
Address of Customer: -  
Request No.: -  
Date of receipt: 05-Mar-2014

Date of test: 07-Mar-2014

### Reference equipment used in the calibration

Description:	Model:	Serial No.	Expiry Date:	Traceable to:
Multi function sound calibrator	B&K 4226	2288444	22-Jun-2014	CIGISMEC
Signal generator	DS 360	33873	15-Apr-2014	CEPREI
Signal generator	DS 360	61227	15-Apr-2014	CEPREI

### Ambient conditions

Temperature: 22 ± 1 °C  
Relative humidity: 60 ± 10 %  
Air pressure: 1000 ± 10 hPa

### Test specifications

- The Sound Level Meter has been calibrated in accordance with the requirements as specified in BS 7580: Part 1: 1997 and the lab calibration procedure SMTP004-CA-152.
- The electrical tests were performed using an electrical signal substituted for the microphone which was removed and replaced by an equivalent capacitance within a tolerance of ±20%.
- The acoustic calibration was performed using an B&K 4226 sound calibrator and corrections was applied for the difference between the free-field and pressure responses of the Sound Level Meter.

### Test results

This is to certify that the Sound Level Meter conforms to BS 7580: Part 1: 1997 for the conditions under which the test was performed.

Details of the performed measurements are presented on page 2 of this certificate.

Actual Measurement data are documented on worksheets.

Approved Signatory:

Huang Jian Min/Feng Jun Qi

Date: 12-Mar-2014

Company Chop:



Comments: The results reported in this certificate refer to the condition of the instrument on the date of calibration and carry no implication regarding the long-term stability of the instrument.



## CERTIFICATE OF CALIBRATION

Certificate No.: 13CA1107 01-02

Page: 1 of 2

### Item tested

Description: Acoustical Calibrator (Class 1)  
Manufacturer: Rion Co., Ltd.  
Type/Model No.: NC-73  
Serial/Equipment No.: 10307223 / N.004.08  
Adaptors used: -

### Item submitted by

Customer: AECOM ASIA CO., LTD.  
Address of Customer: -  
Request No.: -  
Date of receipt: 07-Nov-2013

Date of test: 08-Nov-2013

### Reference equipment used in the calibration

Description:	Model:	Serial No.	Expiry Date:	Traceable to:
Lab standard microphone	B&K 4180	2341427	17-Apr-2014	SCL
Preamplifier	B&K 2673	2239857	16-Apr-2014	CEPREI
Measuring amplifier	B&K 2610	2346941	24-Apr-2014	CEPREI
Signal generator	DS 360	61227	15-Apr-2014	CEPREI
Digital multi-meter	34401A	US36087050	10-Dec-2013	CEPREI
Audio analyzer	8903B	GB41300350	15-Apr-2014	CEPREI
Universal counter	53132A	MY40003662	15-Apr-2014	CEPREI

### Ambient conditions

Temperature:  $22 \pm 1$  °C  
Relative humidity:  $60 \pm 10$  %  
Air pressure:  $1000 \pm 10$  hPa

### Test specifications

- The Sound Calibrator has been calibrated in accordance with the requirements as specified in IEC 60942 1997 Annex B and the lab calibration procedure SMTP004-CA-156.
- The calibrator was tested with its axis vertical facing downwards at the specific frequency using insert voltage technique.
- The results are rounded to the nearest 0.01 dB and 0.1 Hz and have not been corrected for variations from a reference pressure of 1013.25 hectoPascals as the maker's information indicates that the instrument is insensitive to pressure changes.

### Test results

This is to certify that the sound calibrator conforms to the requirements of annex B of IEC 60942: 1997 for the conditions under which the test was performed. This does not imply that the sound calibrator meets IEC 60942 under any other conditions.

Details of the performed measurements are presented on **page 2** of this certificate.

Approved Signatory:

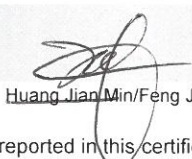
  
Huang Jian Min/Feng Jun Qi

Date: 11-Nov-2013

Company Chop:



**Comments:** The results reported in this certificate refer to the condition of the instrument on the date of calibration and carry no implication regarding the long-term stability of the instrument.



---

---

**APPENDIX F  
EM&A MONITORING SCHEDULES**

---

---

**Contract No. HY/2012/06**  
**Widening of Fanling Highway – Tai Hang to Wo Hop Shek Interchange**  
**Impact Monitoring and Audit Schedule for August 2014**

Sunday	Monday	Tuesday	Wednesday	Thursday	Friday	Saturday
					1-Aug	2-Aug
						1-hr TSP 24-hr TSP
3-Aug	4-Aug	5-Aug	6-Aug	7-Aug	8-Aug	9-Aug
				1-hr TSP 24-hr TSP Noise		
10-Aug	11-Aug	12-Aug	13-Aug	14-Aug	15-Aug	16-Aug
			1-hr TSP 24-hr TSP Noise			
17-Aug	18-Aug	19-Aug	20-Aug	21-Aug	22-Aug	23-Aug
		1-hr TSP 24-hr TSP Noise				
24-Aug	25-Aug	26-Aug	27-Aug	28-Aug	29-Aug	30-Aug
	1-hr TSP 24-hr TSP Noise					1-hr TSP 24-hr TSP
31-Aug						

**Contract No. HY/2012/06**  
**Widening of Fanling Highway – Tai Hang to Wo Hop Shek Interchange**  
**Tentative Impact Monitoring and Audit Schedule for September 2014**

Sunday	Monday	Tuesday	Wednesday	Thursday	Friday	Saturday
	1-Sep	2-Sep	3-Sep	4-Sep	5-Sep	6-Sep
					1-hr TSP 24-hr TSP Noise	
7-Sep	8-Sep	9-Sep	10-Sep	11-Sep	12-Sep	13-Sep
				1-hr TSP 24-hr TSP Noise		
14-Sep	15-Sep	16-Sep	17-Sep	18-Sep	19-Sep	20-Sep
	1-hr TSP 24-hr TSP Noise					1-hr TSP 24-hr TSP
21-Sep	22-Sep	23-Sep	24-Sep	25-Sep	26-Sep	27-Sep
					1-hr TSP 24-hr TSP Noise	
28-Sep	29-Sep	30-Sep				
		1-hr TSP 24-hr TSP Noise				

The schedule is subject to change due to unforeseeable circumstances (e.g. adverse weather, etc)

---

---

**APPENDIX G  
IMPACT AIR QUALITY MONITORING  
RESULTS AND THEIR GRAPHICAL  
PRESENTATION**

---

---

**Appendix G**  
**Impact Air Quality Monitoring Results**

**24-hour TSP Monitoring Results at Station AM2 (Fanling Government Secondary School)**

Date	Weather Condition	Air Temp. (°C)	Atmospheric Pressure(hPa)	Flow Rate (m <sup>3</sup> /min.)		Av. flow (m <sup>3</sup> /min)	Total vol. (m <sup>3</sup> )	Filter Weight (g)		Particulate weight(g)	Elapse Time		Sampling Time(hrs.)	Conc. (µg/m <sup>3</sup> )	Action Level (µg/m <sup>3</sup> )	Limit Level (µg/m <sup>3</sup> )
				Initial	Final			Initial	Final		Initial	Final				
2-Aug-14	Sunny	29.7	1001.4	1.314	1.314	1.314	1892.2	2.7041	2.7630	0.0589	4281.02	4305.02	24.00	31.1	200.7	260
7-Aug-14	Fine	29.0	1003.3	1.314	1.314	1.314	1892.2	2.7355	2.7656	0.0301	4305.02	4329.02	24.00	15.9	200.7	260
13-Aug-14	Rainy	26.0	1003.5	1.314	1.314	1.314	1892.2	2.7245	2.7530	0.0285	4329.02	4353.02	24.00	15.1	200.7	260
19-Aug-14	Sunny	27.4	1008.7	1.314	1.314	1.314	1892.2	2.7675	2.8083	0.0408	4353.02	4377.02	24.00	21.6	200.7	260
25-Aug-14	Sunny	29.9	1010.1	1.314	1.314	1.314	1892.2	2.6675	2.6951	0.0276	4377.02	4401.02	24.00	14.6	200.7	260
30-Aug-14	Sunny	30.1	1011.1	1.314	1.314	1.314	1892.2	2.7063	2.7654	0.0591	4401.02	4425.02	24.00	31.2	200.7	260
													Average	21.6		
													Min	14.6		
													Max	31.2		

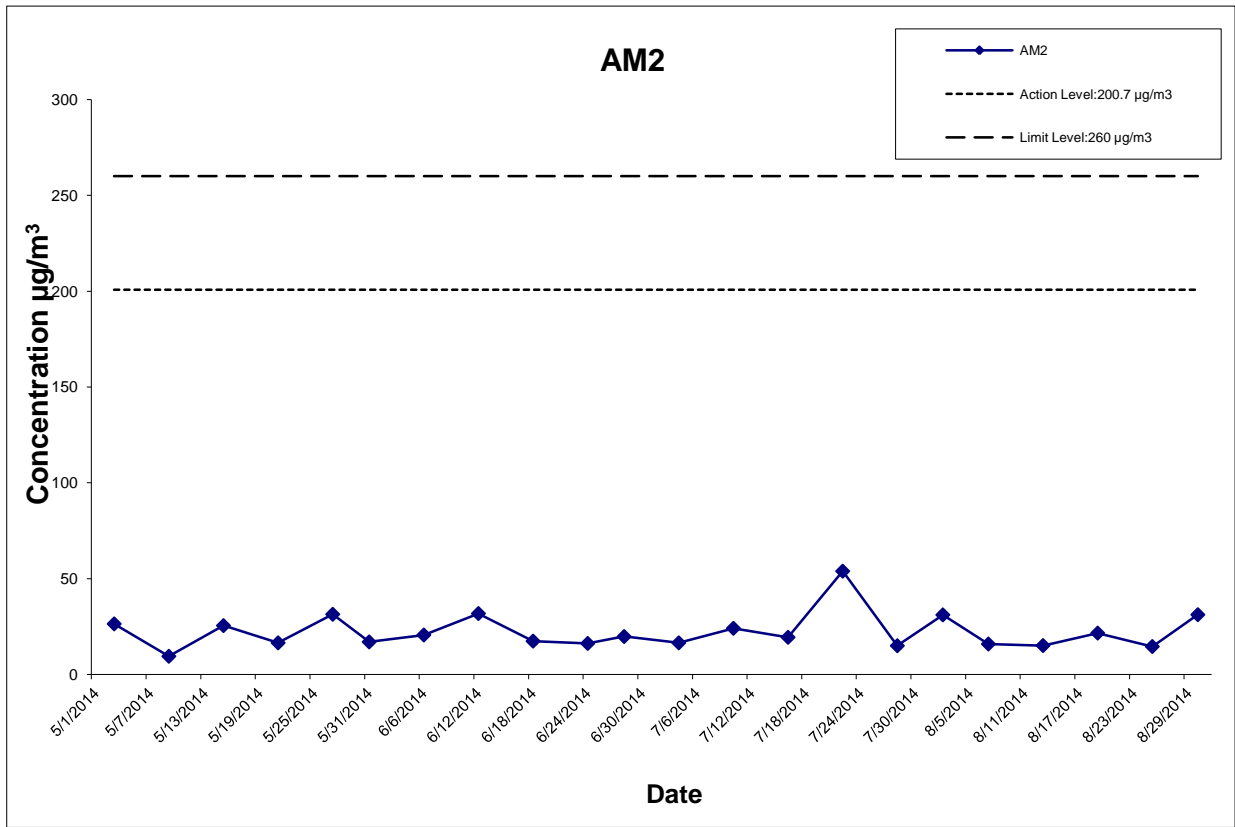

This Drawing has been prepared for the use of AECOM's client. It may not be used, modified, reproduced or relied upon by third parties, except as agreed by AECOM or as required by law. AECOM accepts no responsibility, and denies any liability whatsoever, to any party that uses or relies on this drawing without AECOM's express written consent.

CONTRACT NO. HY/2012/06  
 WIDENING OF FANLING HIGHWAY  
 - TAI HANG TO WO HOP SHEK INTERCHANGE



Graphical Presentation of Impact 24-hour TSP Monitoring Results

Project No.: 60307376

Date: Sep-14

Appendix G

**Appendix G**  
**Impact Air Quality Monitoring Results**

**1-hour TSP Monitoring Results at Station AM2**  
**(Fanling Government Secondary School)**

Date	Start Time (hh:mm)	1st Hour Conc. ( $\mu\text{g}/\text{m}^3$ )	2nd Hour Conc. ( $\mu\text{g}/\text{m}^3$ )	3rd Hour Conc. ( $\mu\text{g}/\text{m}^3$ )
2-Aug-14	13:02	73.5	74.8	75.5
7-Aug-14	11:09	74.1	75.2	73.9
13-Aug-14	11:45	62.0	65.4	63.4
19-Aug-14	14:05	62.4	61.7	65.6
25-Aug-14	12:00	78.6	74.8	77.2
30-Aug-14	10:10	69.6	71.2	72.4
			Average	70.6
			Min	61.7
			Max	78.6

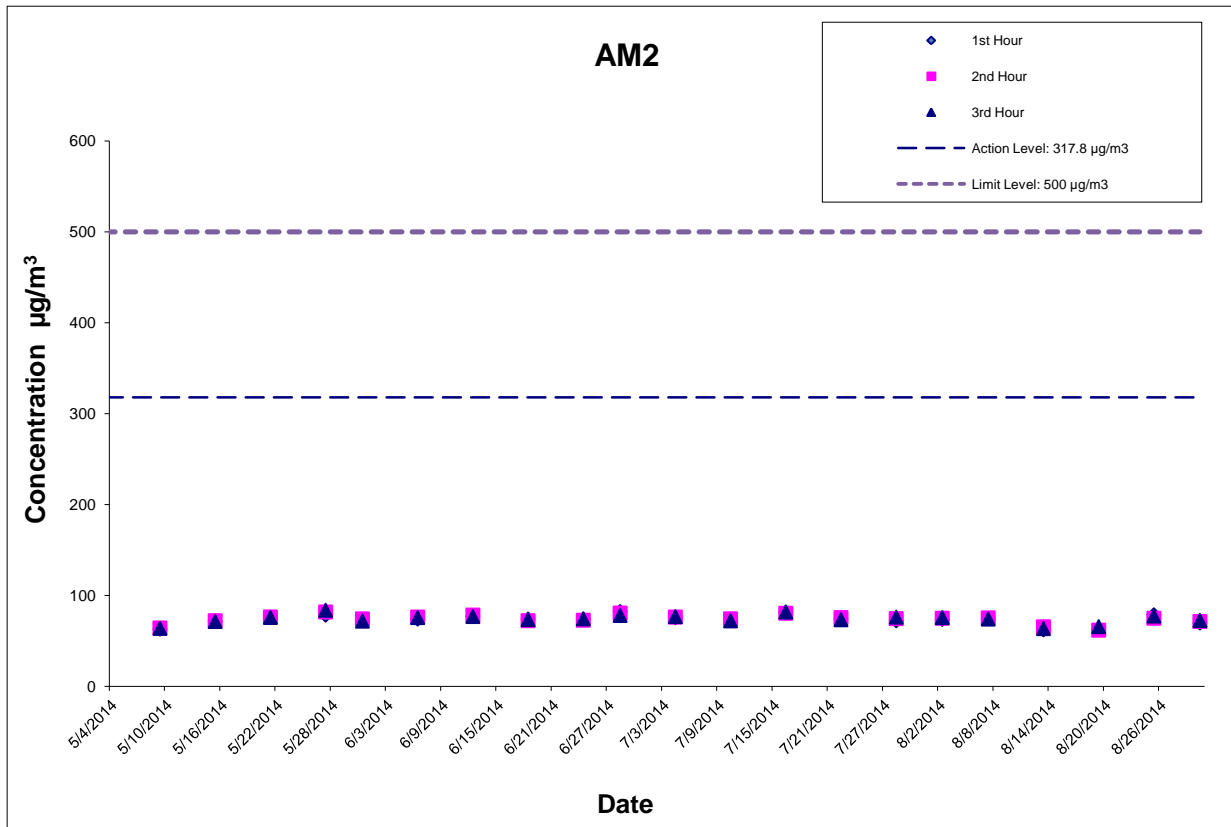

This Drawing has been prepared for the use of AECOM's client. It may not be used, modified, reproduced or relied upon by third parties, except as agreed by AECOM or as required by law. AECOM accepts no responsibility, and denies any liability whatsoever, to any party that uses or relies on this drawing without AECOM's express written consent.

CONTRACT NO. HY/2012/06  
 WIDENING OF FANLING HIGHWAY  
 - TAI HANG TO WO HOP SHEK INTERCHANGE



Graphical Presentation of Impact 1-hour TSP Monitoring Results

Project No.: 60307376

Date: Sep-14

Appendix G



---

---

**APPENDIX H  
METEOROLOGICAL DATA FOR THE  
REPORTING MONTH**

---

---

**Extract of Meteorological Observations for Tai Po Automatic Weather Station,  
August 2014**

Date	Mean Pressure at M.S.L. (hPa)	Air Temperature			Mean Dew Point Temperature (deg C)	Relative Humidity		
		Max. (deg C)	Mean (deg C)	Min. (deg C)		Max. (%)	Mean (%)	Min. (%)
1-Aug	1000.2	35.6	29.8	24.7	24.5	97	75	48
2-Aug	1000.5	34.1	29.3	24.4	25	96	78	56
3-Aug	1001	31	27.9	25.3	25.3	96	86	74
4-Aug	1001.6	30.6	28.3	25.3	25.8	98	86	73
5-Aug	1002.6	30.9	28.8	26.8	25.9	95	85	70
6-Aug	1002.8	29.1	27.7	25.8	25.7	97	89	77
7-Aug	1002.4	32.1	27.7	25.6	25.9	96	90	69
8-Aug	1002.1	32.2	29.1	26	25.2	93	80	62
9-Aug	1003.3	33.5	29.4	26.4	25.3	96	80	57
10-Aug	1003.6	32.8	29.8	28	25	88	76	63
11-Aug	1002.3	31.7	29	27.2	25.4	95	81	61
12-Aug	1001.1	31.6	28.2	26	25.9	97	88	72
13-Aug	1002.8	26.8	25.5	24.7	25	99	97	91
14-Aug	1007.2	30.3	27.5	25.1	25.2	98	87	73
15-Aug	1009.2	32.9	28.8	25.7	24.9	96	81	61
16-Aug	1007.6	33	29.1	26.3	24.6	92	77	59
17-Aug	1006.2	33.4	29.1	25.1	24.2	90	75	56
18-Aug	1007.2	33.5	29.6	26.5	24.3	90	74	53
19-Aug	1007.7	31.7	27.2	24.4	24.7	98	87	68
20-Aug	1009.7	25.8	24.5	23.4	23.6	98	95	88
21-Aug	1010	29.1	26.1	23.5	24	99	89	73
22-Aug	1009.9	30.2	27.1	25.4	24.8	96	88	69
23-Aug	1009	31.1	27.8	25.2	24.7	94	83	70
24-Aug	1008.9	31.8	28.3	25.2	24.1	93	79	60
25-Aug	1009.4	33	28.9	25.6	24.7	93	79	57
26-Aug	1010	32.5	29.2	26.4	25	94	79	61
27-Aug	1009.6	30.4	29.1	27.3	24.9	93	78	67
28-Aug	1011.6	30.6	29	28	25.1	89	80	66
29-Aug	1011.8	32	29.1	26.6	24.5	95	77	58
30-Aug	1010.4	31.9	29	26.2	24.3	90	77	59
31-Aug	1008.9	30.4	28.7	26.8	25.2	92	81	71
<b>Mean</b>	1006.1	31.5	28.3	25.8	24.9	95	82	66
<b>Maximum</b>	1011.8	35.6	29.8	28	25.9	99	97	91
<b>Minimum</b>	1000.2	25.8	24.5	23.4	23.6	88	74	48

**Extract of Meteorological Observations for Tai Po Automatic Weather Station,  
August 2014**

<b>Date</b>	<b>Total Rainfall (mm)</b>	<b>Prevailing Wind Direction (degrees)</b>	<b>Mean Wind Speed (km/h)</b>
1-Aug	*****	***	*****
2-Aug	*****	***	*****
3-Aug	*****	***	*****
4-Aug	*****	***	*****
5-Aug	*****	***	*****
6-Aug	*****	***	*****
7-Aug	*****	***	*****
8-Aug	*****	***	*****
9-Aug	*****	***	*****
10-Aug	*****	***	*****
11-Aug	*****	***	*****
12-Aug	*****	***	*****
13-Aug	*****	***	*****
14-Aug	*****	***	*****
15-Aug	*****	***	*****
16-Aug	*****	***	*****
17-Aug	*****	***	*****
18-Aug	*****	***	*****
19-Aug	*****	***	*****
20-Aug	*****	***	*****
21-Aug	*****	***	*****
22-Aug	*****	***	*****
23-Aug	*****	***	*****
24-Aug	*****	***	*****
25-Aug	*****	***	*****
26-Aug	*****	***	*****
27-Aug	*****	***	*****
28-Aug	*****	***	*****
29-Aug	*****	***	*****
30-Aug	*****	***	*****
31-Aug	*****	***	*****
<b>Mean</b>	-----	***	*****
<b>Total</b>	*****	---	-----
<b>Maximum</b>	*****	---	*****
<b>Minimum</b>	*****	---	*****

\*\*\* unavailable

# missing (less than 24 hourly observations a day)

Rainfall measured in increment of 0.5 mm. Amount of < 0.5 mm cannot be detected

**Extract of Meteorological Observations for Tai Mei Tuk Automatic Weather Station,  
August 2014**

Date	Mean Pressure at M.S.L. (hPa)	Air Temperature			Mean Dew Point Temperature (deg C)	Relative Humidity		
		Max. (deg C)	Mean (deg C)	Min. (deg C)		Max. (%)	Mean (%)	Min. (%)
1-Aug	*****	35.7	30.3	24.8	****	***	***	***
2-Aug	*****	34	29.8	25	****	***	***	***
3-Aug	*****	34	28.9	25.5	****	***	***	***
4-Aug	*****	34.8	29.6	27.8	****	***	***	***
5-Aug	*****	34	29.5	27.5	****	***	***	***
6-Aug	*****	32.6	28.4	26.4	****	***	***	***
7-Aug	*****	32.6	28.7	27.2	****	***	***	***
8-Aug	*****	34.5	29.8	26.8	****	***	***	***
9-Aug	*****	34.1	30.1	27.4	****	***	***	***
10-Aug	*****	32.6	29.9	27.7	****	***	***	***
11-Aug	*****	34.6	29.4	27.1	****	***	***	***
12-Aug	*****	33.1	28.6#	25.6	****	***	***	***
13-Aug	*****	27.7	25.9	24.9	****	***	***	***
14-Aug	*****	31.6	27.9	25.5	****	***	***	***
15-Aug	*****	33.2	29.4	26.6	****	***	***	***
16-Aug	*****	33.3	29.6	27	****	***	***	***
17-Aug	*****	34	29.8	26	****	***	***	***
18-Aug	*****	34	30.1	26.7	****	***	***	***
19-Aug	*****	32.2	28	24.8	****	***	***	***
20-Aug	*****	27.4	25	23.7	****	***	***	***
21-Aug	*****	31.3	27	24.1	****	***	***	***
22-Aug	*****	32.3	28.1	26.2	****	***	***	***
23-Aug	*****	32.7	28.7	25.8	****	***	***	***
24-Aug	*****	34	29.1	26	****	***	***	***
25-Aug	*****	34.4	29.7	26.5	****	***	***	***
26-Aug	*****	34.5	29.7	26.9	****	***	***	***
27-Aug	*****	30.9	29	27	****	***	***	***
28-Aug	*****	31.9	29	27.1	****	***	***	***
29-Aug	*****	33.7	29.6	26.8	****	***	***	***
30-Aug	*****	34.2	29.7	27.1	****	***	***	***
31-Aug	*****	31.3	28.6	26.5	****	***	***	***
<b>Mean</b>	*****	32.9	28.9#	26.3	****	***	***	***
<b>Maximum</b>	*****	35.7	30.3#	27.8	****	***	***	***
<b>Minimum</b>	*****	27.4	25.0#	23.7	****	***	***	***

**Extract of Meteorological Observations for Tai Mei Tuk Automatic Weather Station,  
August 2014**

<b>Date</b>	<b>Total Rainfall (mm)</b>	<b>Prevailing Wind Direction (degrees)</b>	<b>Mean Wind Speed (km/h)</b>
1-Aug	9.0	270	14.7
2-Aug	1.0	240	8.8
3-Aug	24.5	260	5.8
4-Aug	3.5	60	5.4
5-Aug	0.0	70	6.5
6-Aug	1.0	270	6.0
7-Aug	1.5	260	6.0
8-Aug	0.0	230	9.1
9-Aug	0.0	240	11.9
10-Aug	0.0	260	15.8
11-Aug	15.5	260	8.0
12-Aug	26.0#	240#	8.5#
13-Aug	55.0	50	7.8
14-Aug	2.5	240	10.3
15-Aug	0.0	260	9.8
16-Aug	0.0	260	12.3
17-Aug	0.0	260	11.0
18-Aug	0.0	260	11.0
19-Aug	7.0	270	11.8
20-Aug	20.5	140	5.8
21-Aug	2.5	50	5.4
22-Aug	1.5	50	4.7
23-Aug	0.0	150	5.0
24-Aug	0.0	120	5.4
25-Aug	0.0	140	6.8
26-Aug	0.0	40	12.8
27-Aug	1.0	70	30.8
28-Aug	0.5	90	22.4
29-Aug	0.0	70	10.6
30-Aug	0.0	90	10.8
31-Aug	2.5	90	17.7
<b>Mean</b>	-----	260#	10.3#
<b>Total</b>	175.0#	---	-----
<b>Maximum</b>	55.0#	---	30.8#
<b>Minimum</b>	0.0#	---	4.7#

\*\*\* unavailable

# missing (less than 24 hourly observations a day)

Rainfall measured in increment of 0.5 mm. Amount of < 0.5 mm cannot be detected

---

---

**APPENDIX I  
IMPACT DAYTIME CONSTRUCTION NOISE  
MONITORING RESULTS AND THEIR  
GRAPHICAL PRESENTATION**

---

---

## Appendix I Impact Daytime Construction Noise Monitoring Resu

### Location : M2 (West Tai Wo - Free Field)

Day time 07:00-19:00 hrs Normal Weekdays Impact Noise Monitoring Results

Date	Measured Noise Level for 30-min, dB(A)				Limit Level, dB(A)	Exceedance (Y/N)
	Start Time	Leq*	L10*	L90*		
7-Aug-14	11:20	69.7	72.1	67.3	75	N
13-Aug-14	14:30	67.1	68.0	65.9	75	N
19-Aug-14	15:00	66.8	68.0	64.4	75	N
25-Aug-14	13:05	72.6	76.2	70.4	75	N
	Min	66.8	68.0	64.4		
	Max	72.6	76.2	70.4		
	Average	69.7	72.5	67.6		

### Location : M3 (Fanling Government Secondary School- Façade)

Day time 07:00-19:00 hrs Normal Weekdays Impact Noise Monitoring Results

Date	Measured Noise Level for 30-min, dB(A)				Limit Level, dB(A)^	Exceedance (Y/N)
	Start Time	Leq	L10	L90		
7-Aug-14	13:31	67.5	69.1	65.4	70	N
13-Aug-14	15:15	61.1	62.5	57.0	70	N
19-Aug-14	14:00	62.1	63.5	59.0	70	N
25-Aug-14	13:52	66.8	69.4	62.6	70	N
	Min	61.1	62.5	57.0		
	Max	67.5	69.4	65.4		
	Average	65.2	67.2	62.2		

\* +3dB(A) Façade effect correction included

^ Limit Level of 70dB(A) applies to education institutes while 65dB(A) applies during school examination period.

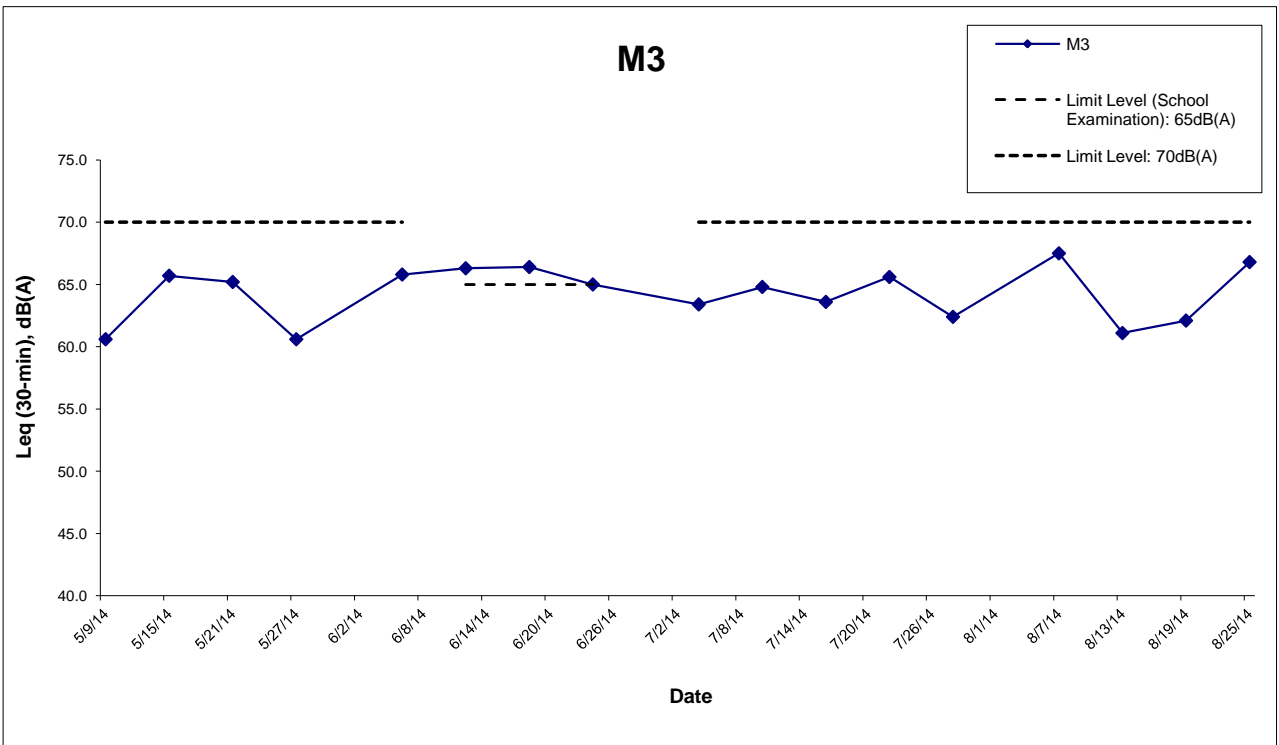
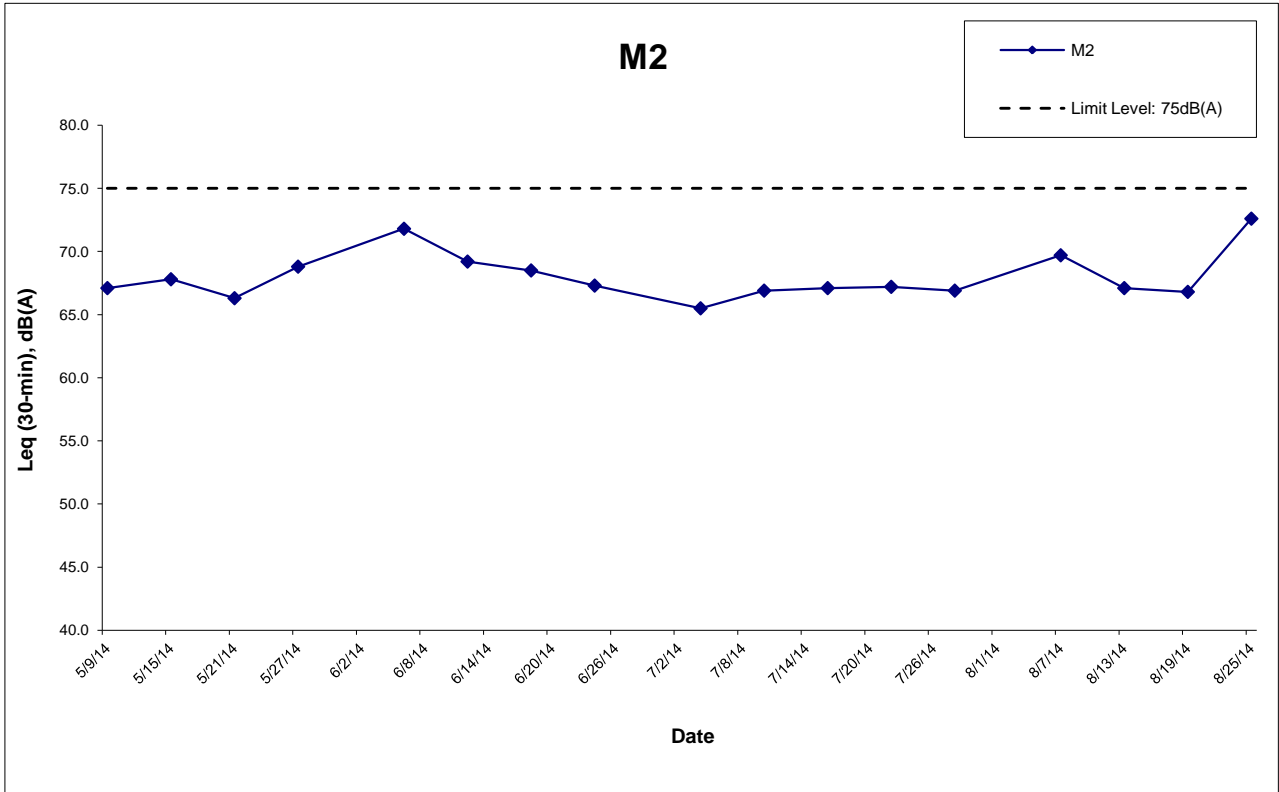

Remark:

^ Limit Level of 70dB(A) applies to education institutes while 65dB(A) applies during school examination period.

This Drawing has been prepared for the use of AECOM's client. It may not be used, modified, reproduced or relied upon by third parties, except as agreed by AECOM or as required by law. AECOM accepts no responsibility, and denies any liability whatsoever, to any party that uses or relies on this drawing without AECOM's express written consent.

CONTRACT NO. HY/2012/06  
 WIDENING OF FANLING HIGHWAY  
 - TAI HANG TO WO HOP SHEK INTERCHANGE



Graphical Presentation of Impact Daytime Construction Noise  
 Monitoring Results

Project No.: 60307376

Date: Sep-14

Appendix I



---

---

**APPENDIX J  
EVENT ACTION PLAN**

---

---

## Appendix J – Event Action Plan

### Event / Action Plan for Air Quality

Event	Action			
	ET Leader	IEC	ER	Contractor
<b>Action Level</b>				
Exceedance for one sample	<ol style="list-style-type: none"> <li>1. Identify source;</li> <li>2. Inform IEC and ER;</li> <li>3. Repeat measurement to confirm finding;</li> <li>4. Increase monitoring frequency to daily.</li> </ol>	<ol style="list-style-type: none"> <li>1. Check monitoring data submitted by ET;</li> <li>2. Check Contractor's working method.</li> </ol>	<ol style="list-style-type: none"> <li>1. Notify Contractor.</li> </ol>	<ol style="list-style-type: none"> <li>1. Rectify any unacceptable practice;</li> <li>2. Amend working methods if appropriate.</li> </ol>
Exceedance for two or more consecutive samples	<ol style="list-style-type: none"> <li>1. Identify source;</li> <li>2. Inform IEC and ER;</li> <li>3. Repeat measurements to confirm findings;</li> <li>4. Increase monitoring frequency to daily;</li> <li>5. Discuss with IEC and Contractor on remedial actions required;</li> <li>6. If exceedance continues, arrange meeting with IEC and ER;</li> <li>7. If exceedance stops, cease additional monitoring.</li> </ol>	<ol style="list-style-type: none"> <li>1. Check monitoring data submitted by ET;</li> <li>2. Check Contractor's working method;</li> <li>3. Discuss with ET and Contractor on possible remedial measures;</li> <li>4. Advise the ER on the effectiveness of the proposed remedial measures;</li> <li>5. Supervise Implementation of remedial measures.</li> </ol>	<ol style="list-style-type: none"> <li>1. Confirm receipt of notification of failure in writing;</li> <li>2. Notify Contractor;</li> <li>3. Ensure remedial measures properly implemented.</li> </ol>	<ol style="list-style-type: none"> <li>1. Submit proposals for remedial actions to IEC within 3 working days of notification;</li> <li>2. Implement the agreed proposals;</li> <li>3. Amend proposal if appropriate.</li> </ol>

Event / Action Plan for Air Quality

Event Action Level	Action			
	ET Leader	IEC	ER	Contractor
<b>Limit Level</b>				
Exceedance for one sample	<ol style="list-style-type: none"> <li>1. Identify source;</li> <li>2. Inform IEC, ER, Contractor and EPD;</li> <li>3. Repeat measurement to confirm finding;</li> <li>4. Increase monitoring frequency to daily;</li> <li>5. Assess effectiveness of Contractor's remedial actions and keep IEC, EPD and ER informed of the results.</li> </ol>	<ol style="list-style-type: none"> <li>1. Check monitoring data submitted by ET;</li> <li>2. Check Contractor's working method;</li> <li>3. Discuss with ET and Contractor on possible remedial measures;</li> <li>4. Advise ER on the effectiveness of the proposed remedial measures;</li> <li>5. Supervise implementation of remedial measures.</li> </ol>	<ol style="list-style-type: none"> <li>1. Confirm receipt of notification of exceedance in writing;</li> <li>2. Notify Contractor;</li> <li>3. Ensure remedial measures properly implemented.</li> </ol>	<ol style="list-style-type: none"> <li>1. Take immediate action to avoid further exceedance;</li> <li>2. Submit proposals for remedial actions to IEC within 3 working days of notification;</li> <li>3. Implement the agreed proposals;</li> <li>4. Amend proposal if appropriate.</li> </ol>
Exceedance for two or more consecutive samples	<ol style="list-style-type: none"> <li>1. Notify IEC, ER, Contractor and EPD;</li> <li>2. Identify source;</li> <li>3. Repeat measurement to confirm findings;</li> <li>4. Increase frequency to daily;</li> <li>5. Analyse Contractor's working procedures to determine possible mitigation to be;</li> <li>6. Arrange meeting with IEC and ER to discuss the remedial actions to be taken;</li> <li>7. Assess effectiveness of Contractor's remedial actions and keep IEC, EPD and ER informed of the results;</li> <li>8. If exceedance stops, cease additional monitoring.</li> </ol>	<ol style="list-style-type: none"> <li>1. Discuss amongst ER, ET, and Contractor on the potential remedial actions;</li> <li>2. Review Contractor's remedial actions whenever necessary to assure their effectiveness and advise ER accordingly;</li> <li>3. Supervise the implementation of remedial measures.</li> </ol>	<ol style="list-style-type: none"> <li>1. Confirm receipt of notification of exceedance in writing;</li> <li>2. Notify Contractor;</li> <li>3. In consultation with the IEC, agree with the Contractor on the remedial measures to be implemented;</li> <li>4. Ensure remedial measures properly implemented;</li> <li>5. If exceedance continues, consider what portion of the work is responsible and instruct the Contractor to stop that portion of work until the exceedance is abated.</li> </ol>	<ol style="list-style-type: none"> <li>1. Take immediate action to avoid further exceedance;</li> <li>2. Submit proposals for remedial actions to IEC within 3 working days of notification;</li> <li>3. Implement the agreed proposals;</li> <li>4. Resubmit proposals if problem still not under control;</li> <li>5. Stop the relevant portion of works as determined by ER until the exceedance is abated.</li> </ol>

Event / Action Plan for Noise Impact

Event Limit Level	Action			
	ET Leader	IEC	ER	Contractor
Action Level	<ol style="list-style-type: none"> <li>1. Notify IEC and the Contractor.</li> <li>2. Carry out investigation.</li> <li>3. Report the results of investigation to IEC and the Contractor.</li> <li>4. Discuss with the Contractor and formulate remedial measures.</li> <li>5. Increase monitoring frequency to check mitigation effectiveness.</li> </ol>	<ol style="list-style-type: none"> <li>1. Review with analysed results submitted by ET.</li> <li>2. Review the proposed remedial measures by the Contractor and advise ER accordingly.</li> <li>3. Supervise the implement of remedial measures.</li> </ol>	<ol style="list-style-type: none"> <li>1. Confirm receipt of notification of failure in writing.</li> <li>2. Notify the Contractor.</li> <li>3. Require the Contractor to propose remedial measures for the analysed noise problem.</li> <li>4. Ensure remedial measures are properly implemented.</li> </ol>	<ol style="list-style-type: none"> <li>1. Submit noise mitigation proposals to IEC.</li> <li>2. Implement noise mitigation proposals.</li> </ol>
Limit Level	<ol style="list-style-type: none"> <li>1. Notify, IEC, ER, EPD and the Contractor.</li> <li>2. Identify the source.</li> <li>3. Repeat measurement to confirm findings.</li> <li>4. Increase monitoring frequency.</li> <li>5. Carry out analysis of Contractor's working procedures to determine possible mitigation to be implemented.</li> <li>6. Inform IEC, ER, and EPD the causes &amp; actions taken for the exceedances.</li> <li>7. Assess effectiveness of the Contractor's remedial actions and keep IEC, EPD and ER informed of the results.</li> <li>8. If exceedance stops, cease additional monitoring.</li> </ol>	<ol style="list-style-type: none"> <li>1. Discuss amongst ER, ET Leader and the Contractor on the potential remedial actions.</li> <li>2. Review the Contractor's remedial actions whenever necessary to assure their effectiveness and advise ER accordingly.</li> <li>3. Supervise the implementation of remedial measures.</li> </ol>	<ol style="list-style-type: none"> <li>1. Confirm receipt of notification of failure in writing.</li> <li>2. Notify the Contractor.</li> <li>3. Require the Contractor to propose remedial measures for the analysed noise problem.</li> <li>4. Ensure remedial measures are properly implemented.</li> <li>5. If exceedance continues, consider what activity of the work is responsible and instruct the Contractor to stop that activity of work until the exceedance is abated.</li> </ol>	<ol style="list-style-type: none"> <li>1. Take immediate action to avoid further exceedance.</li> <li>2. Submit proposals for remedial actions to IEC within 3 working days of notification.</li> <li>3. Implement the agreed proposals.</li> <li>4. Resubmit proposals if problem still not under control.</li> <li>5. Stop the relevant activity of works as determined by the ER until the exceedance is abated.</li> </ol>

---

---

**APPENDIX K  
SITE INSPECTION SUMMARIES**

---

---

## Site Inspection Summary

### Inspection Information

Contract No.	HY/2012/06
Date:	5 August 2014
Time:	14:00
Inspection No.:	38

### Non-compliance

Nil
-----

### Observations

<p><u>Follow-up Observations</u></p> <p>Nil.</p> <p><u>New Observations</u></p> <p>Nil.</p>
------------------------------------------------------------------------------------------------

### Remarks

Nil
-----

*Inspection Information*

Contract No.	HY/2012/06
Date:	14 August 2014
Time:	14:00
Inspection No.:	39

*Non-compliance*

Nil
-----

*Observations*

<p><u>Follow-up Observations</u></p> <p>Nil.</p> <p><u>New Observations</u></p> <p>Nil.</p> <p><u>Reminders</u></p> <p>The Contractor was reminded to use absorptive materials to soak leaked oil, if any, when maintaining the power pack.</p>
-------------------------------------------------------------------------------------------------------------------------------------------------------------------------------------------------------------------------------------------------

*Remarks*

Nil
-----

*Inspection Information*

Contract No.	HY/2012/06
Date:	19 August 2014
Time:	14:00
Inspection No.:	40

*Non-compliance*

Nil
-----

*Observations*

<p><u>Follow-up Observations</u></p> <p>Nil.</p> <p><u>New Observations</u></p> <p>Nil.</p>
------------------------------------------------------------------------------------------------

*Remarks*

Nil
-----



*Inspection Information*

Contract No.	HY/2012/06
Date:	26 August 2014
Time:	14:00
Inspection No.:	41

*Non-compliance*

Nil
-----

*Observations*

<p><u>Follow-up Observations</u></p> <p>Nil.</p> <p><u>New Observations</u></p> <p>1. The Contractor should further wrap the upper part of the breaker with absorptive materials to minimize noise generation.</p>
--------------------------------------------------------------------------------------------------------------------------------------------------------------------------------------------------------------------

*Remarks*

Nil
-----

---

---

**APPENDIX L  
STATISTICS ON COMPLAINTS,  
NOTIFICATION OF SUMMONS AND  
SUCCESSFUL PROSECUTIONS**

---

---

## Appendix L

### Statistics on Complaints, Notifications of Summons and Successful Prosecutions

	Date Received	Subject	Status	Total no. followed up by the ET this month	Total no. followed up by the ET since project commencement
<b>Environmental complaints</b>	19 December 2013	EPD referred a complaint from Lot no. 116 of Fui Sha Wai at Tai Hang of Tai Po which is concerned about the construction noise and diesel-like smell generated from construction activities nearby which caused nuisance and health problems on 19 December 2013 morning.	Closed	0	2
	24 February 2014	EPD referred an air-and-odour complaint on 24 February 2014. The complainant complained about the construction site located near the bus stop in Fui Sha Wai, Tai Hang, Tai Wo Service Road West. When construction works were carried out, odour, white smoke and dust were generated. The complainant asked for follow-up actions.	Closed		
<b>Notification of summons</b>	-	-	-	0	0
<b>Successful Prosecutions</b>	-	-	-	0	0